

Camilla

Typ A

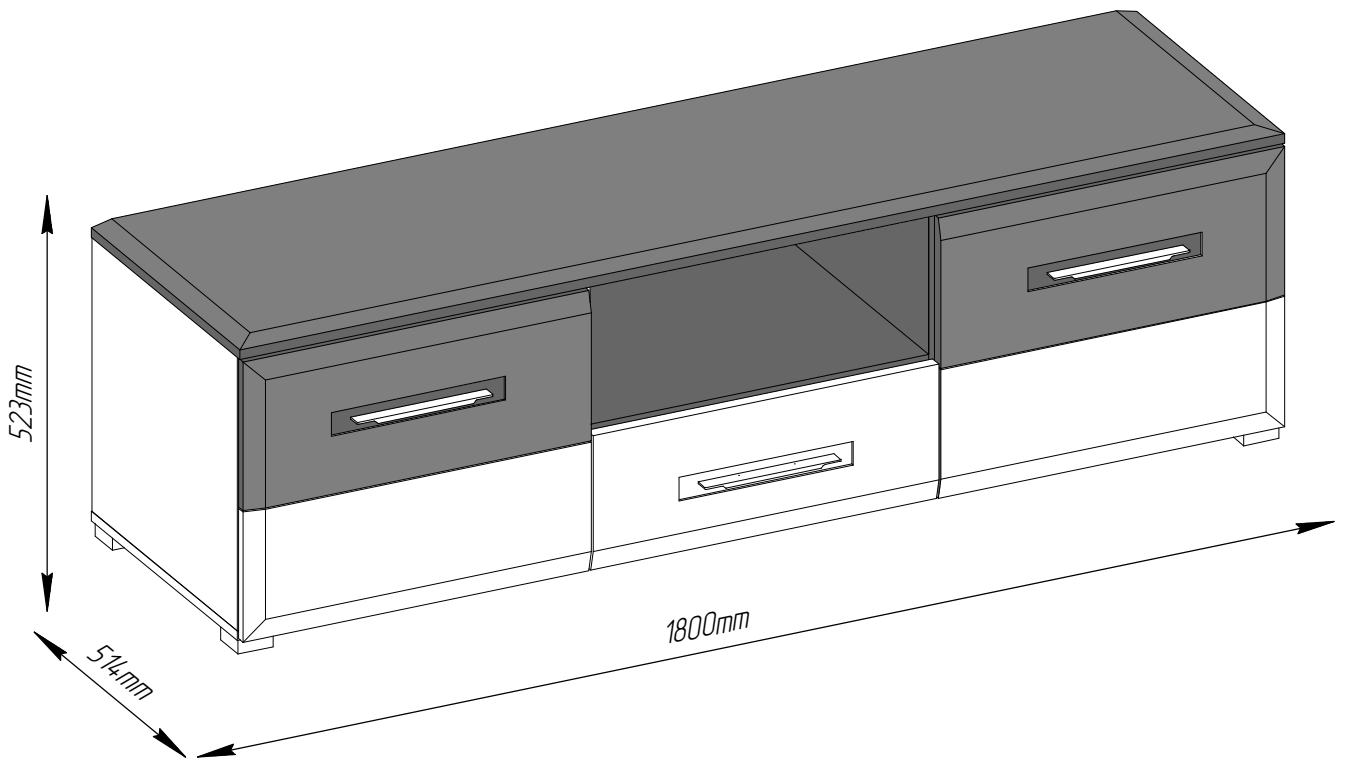

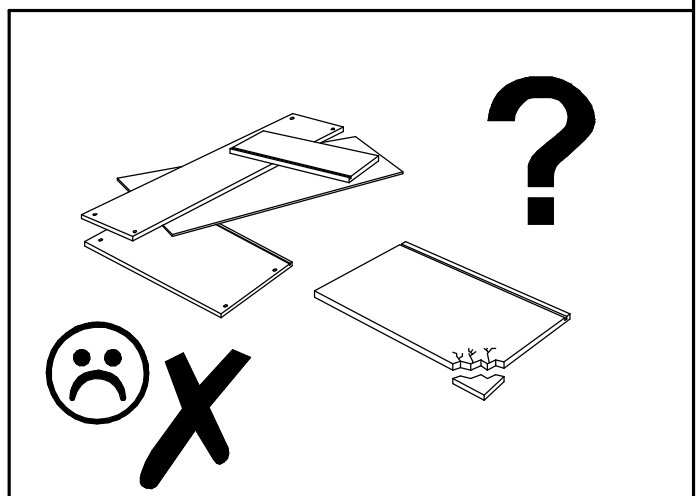

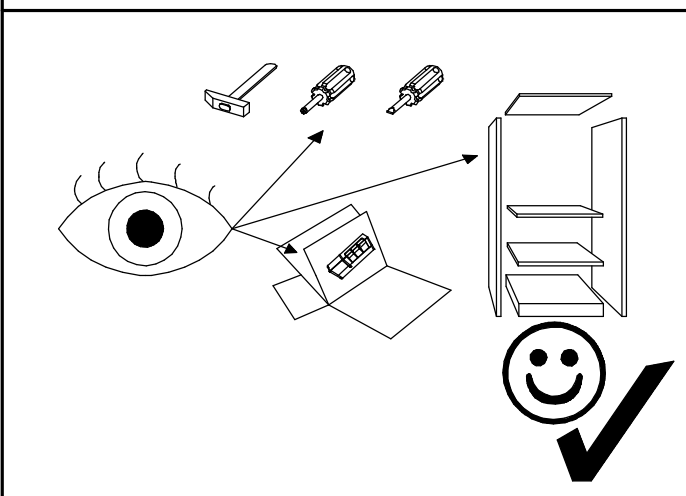
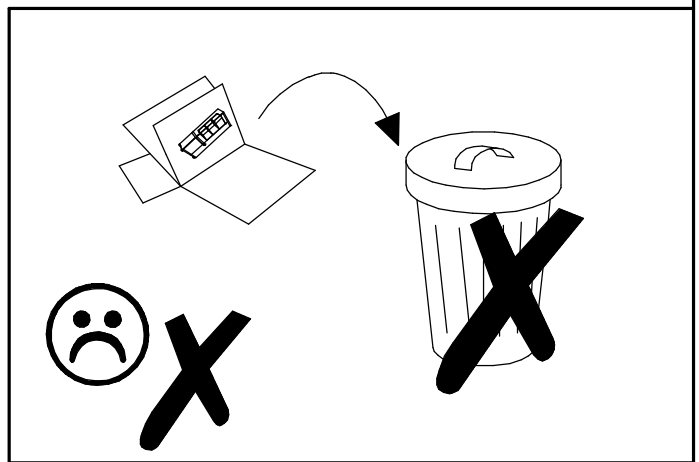
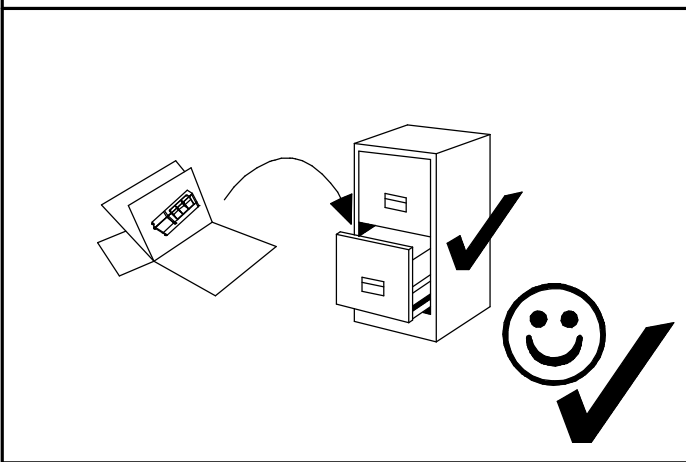
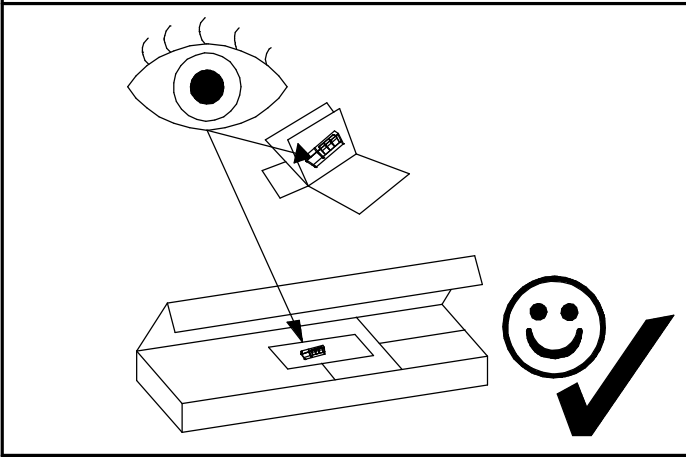
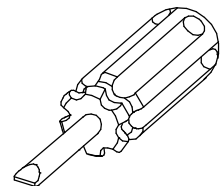
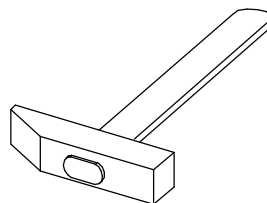
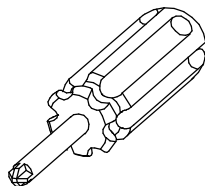
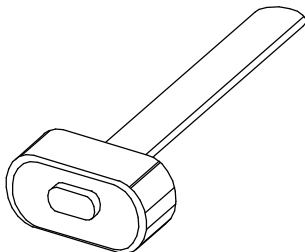
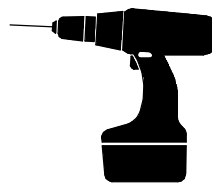
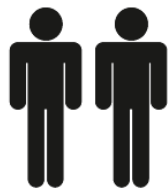
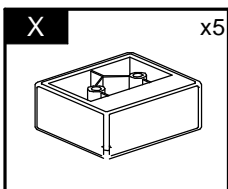
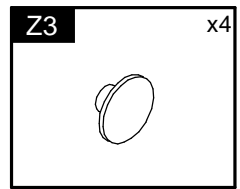
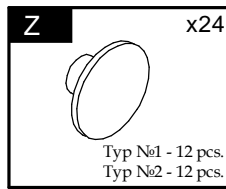
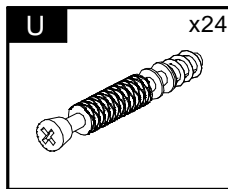
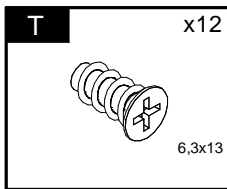
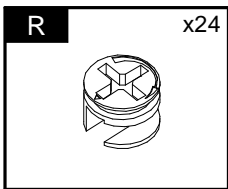
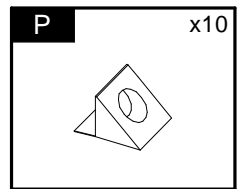
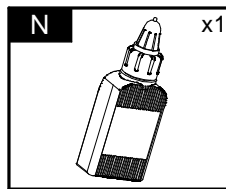
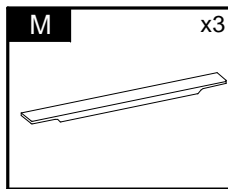
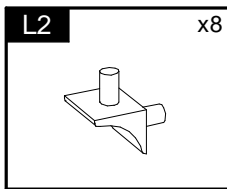
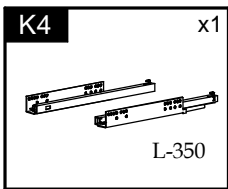
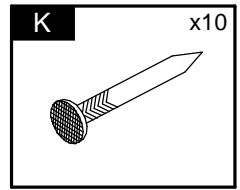
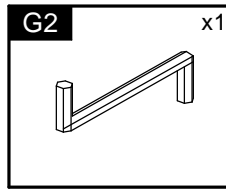
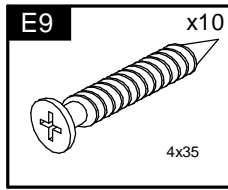
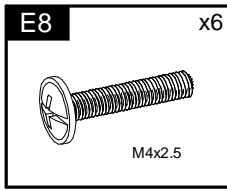
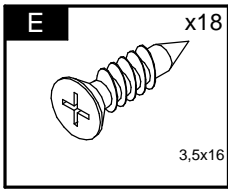
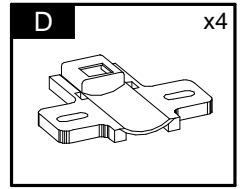
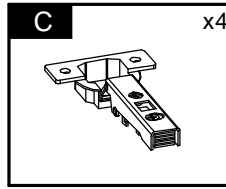
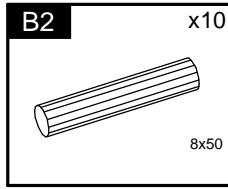
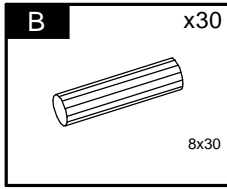
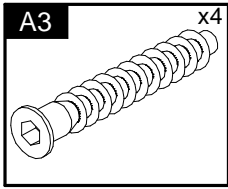
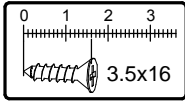
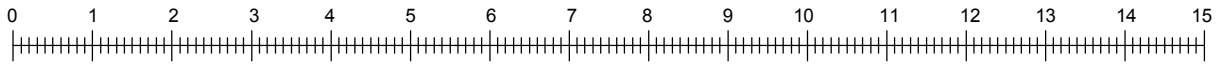

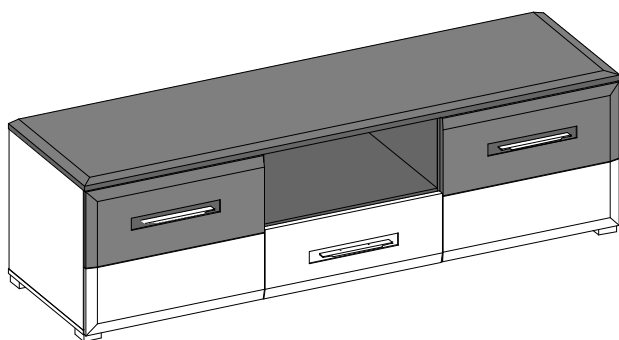

Element symbol	Measurements				Code	Paket
	1	2	3	4		
1	1801	515	19	1	1004_19mdf	2/2
2	463	499.5	16	1	1001	1/2
3	463	499.5	16	1	1002	1/2
4	1800	500	16	1	1003	1/2
5	463	486.5	16	1	1008	1/2
6	463	486.5	16	1	1009	1/2
7	575.5	486	16	1	1005	1/2
8	575.5	486	16	1	1006	1/2
9	583	486	16	1	1010	1/2
10	340	120	16	1	1012	1/2
11	541	106.5	16	1	1013	1/2
12	340	120	16	1	1014	1/2
13	1780	477	2.5	1	1015_v	1/2
14	551	345	2.5	1	N/A	1/2
15	597	238	22	1	3007_bhx	2/2
16	597	238	22	1	3008_bhx	2/2
17	597	238	22	1	3009_bhx	2/2
18	597	238	22	1	3010_bhx	2/2
19	600	237	22	1	3011_bhx	2/2

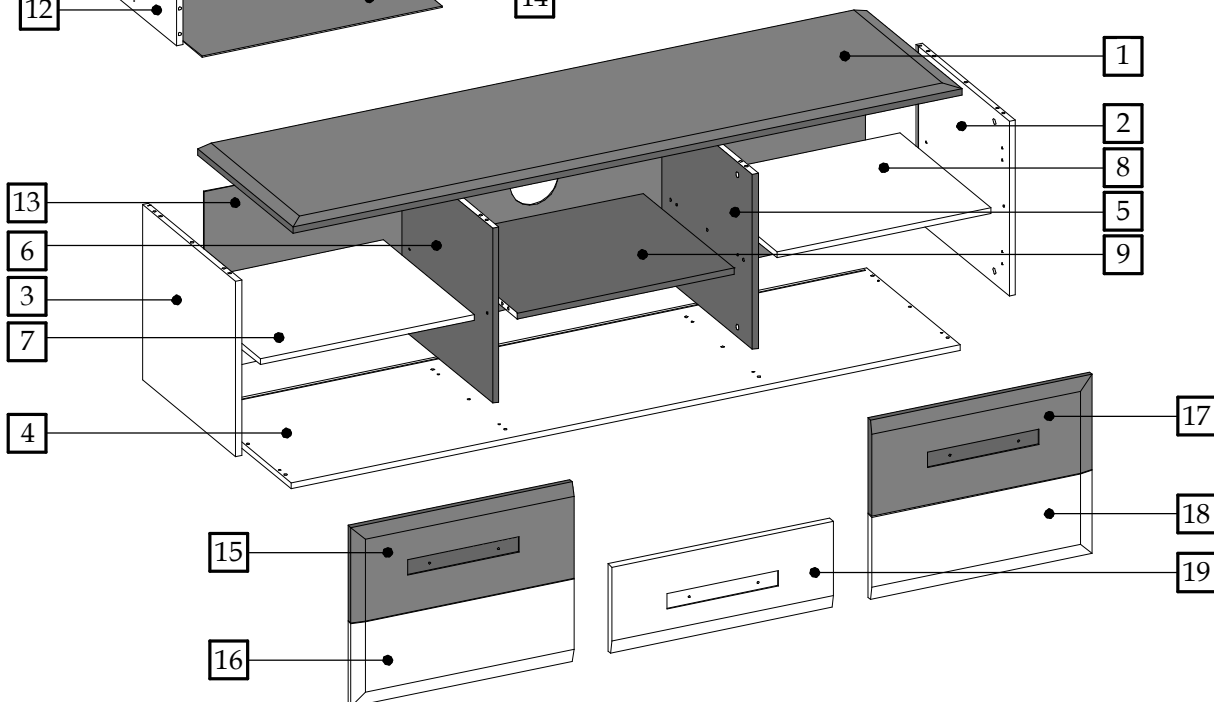
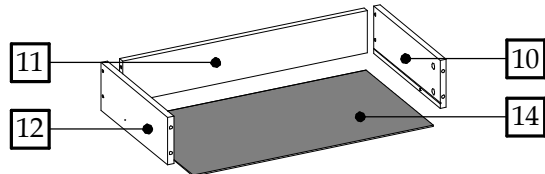



1

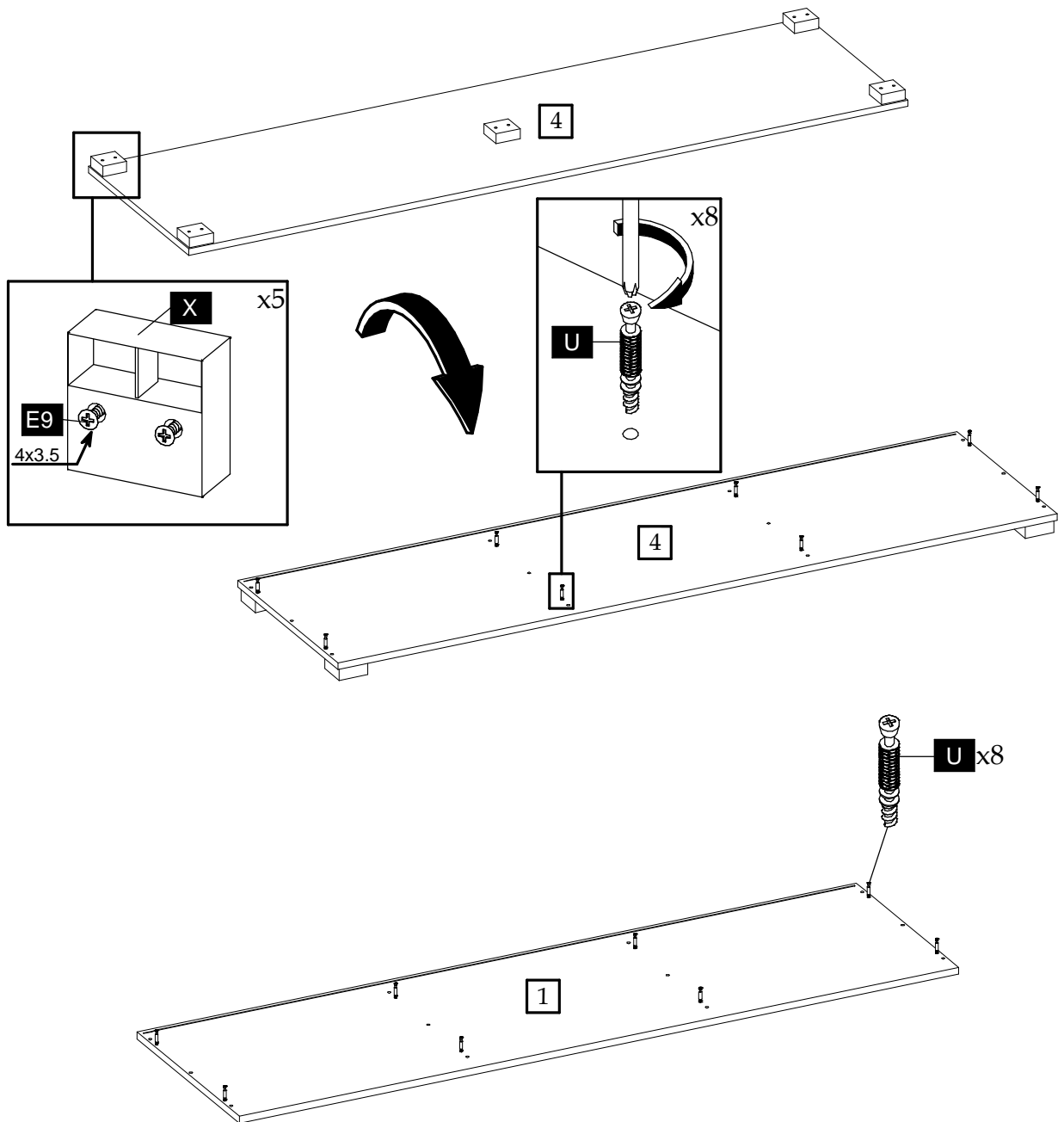

2

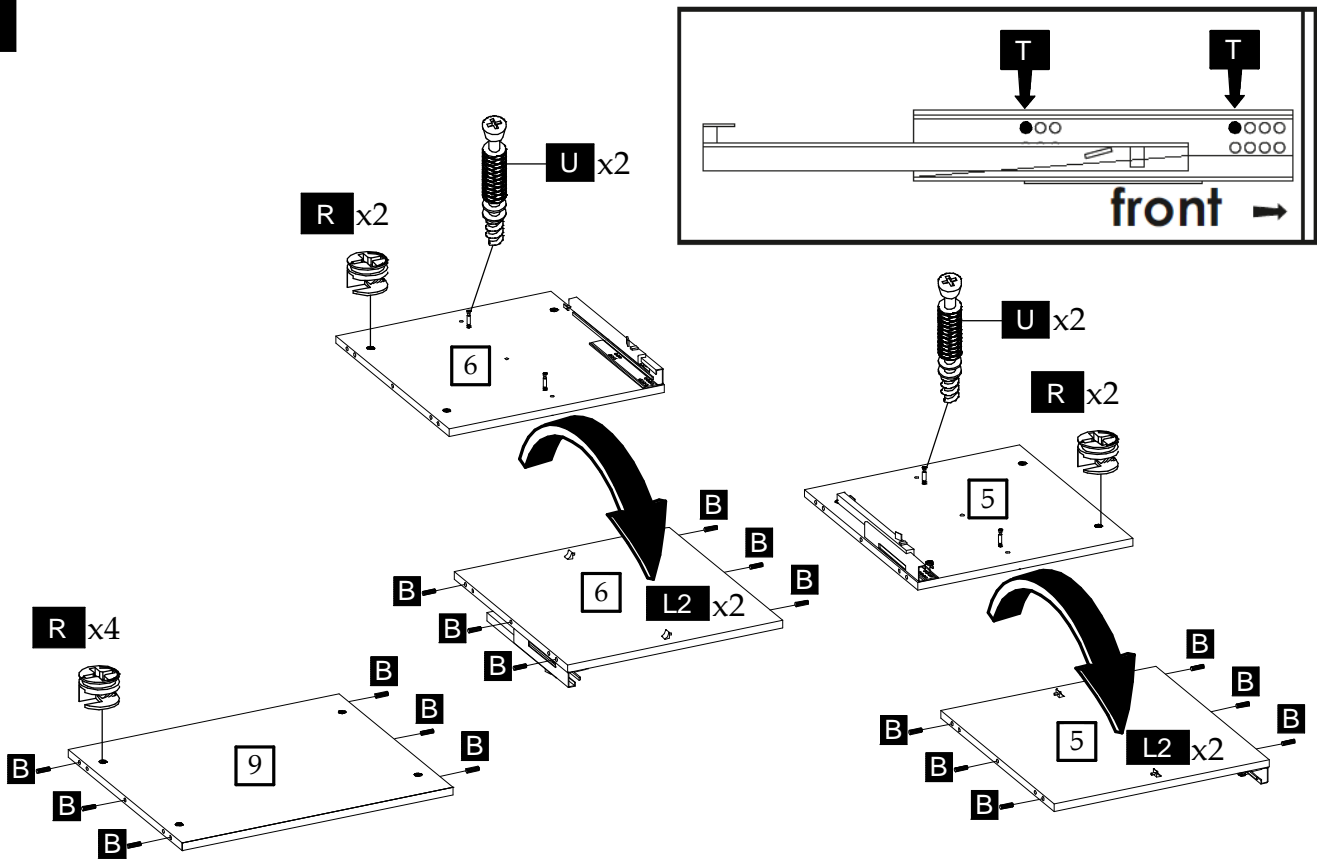

3

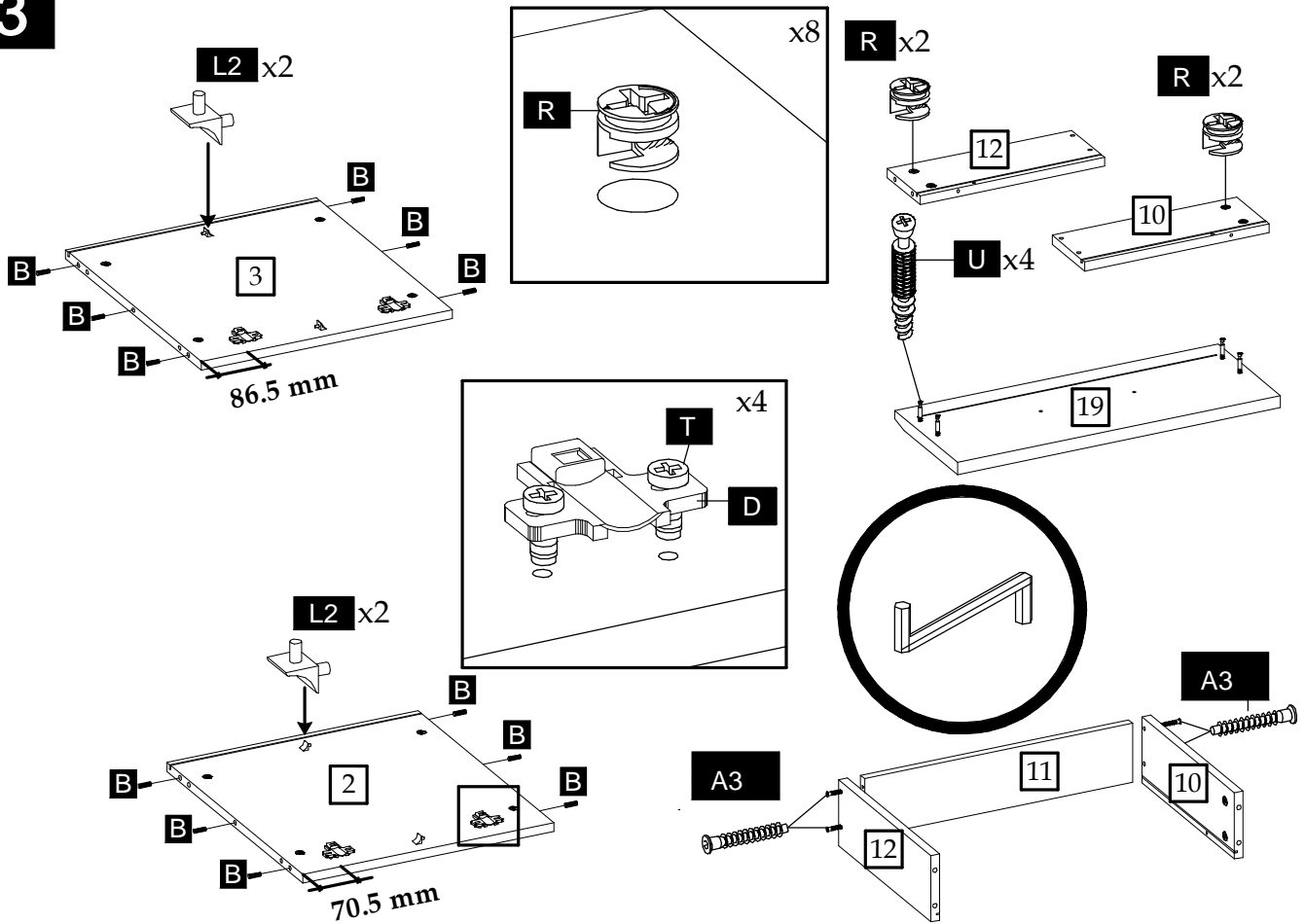

4

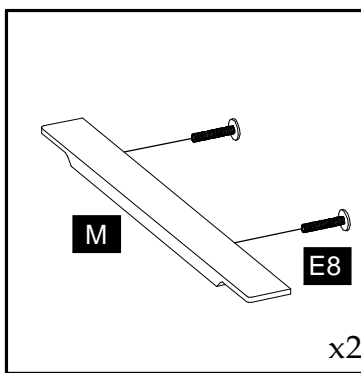
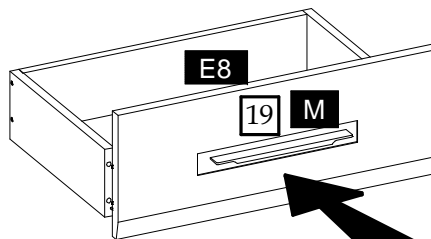
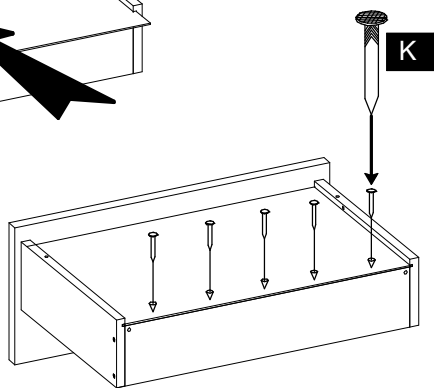
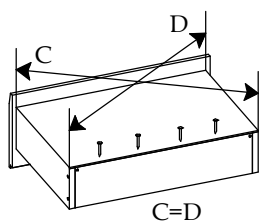
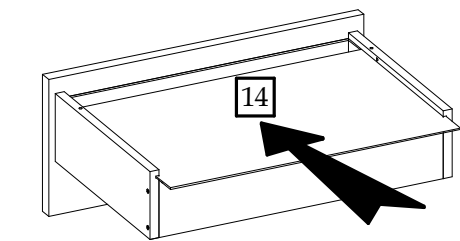
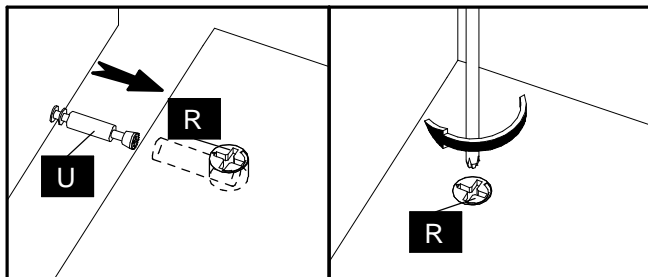

5

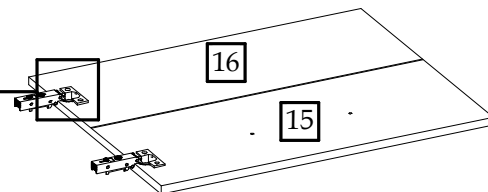
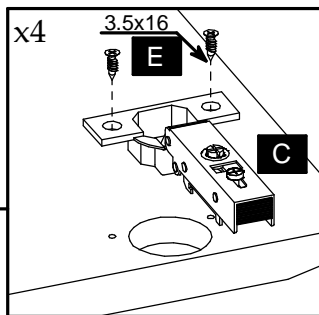
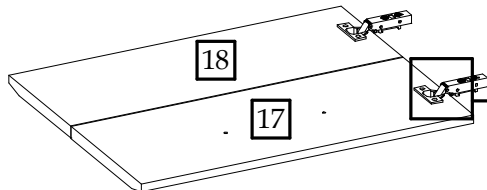
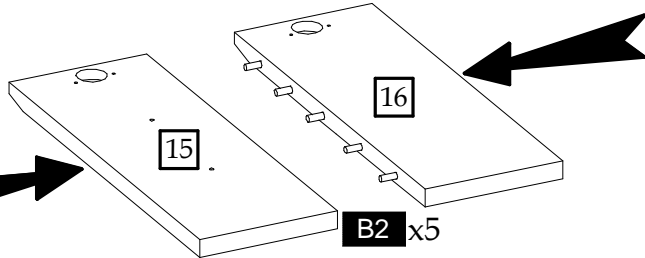
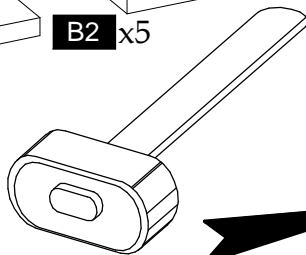
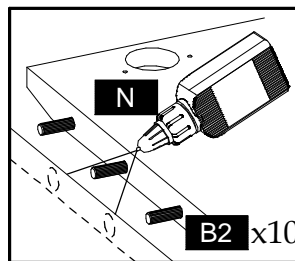
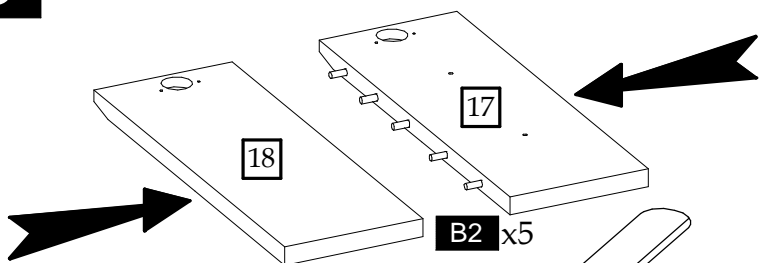

6

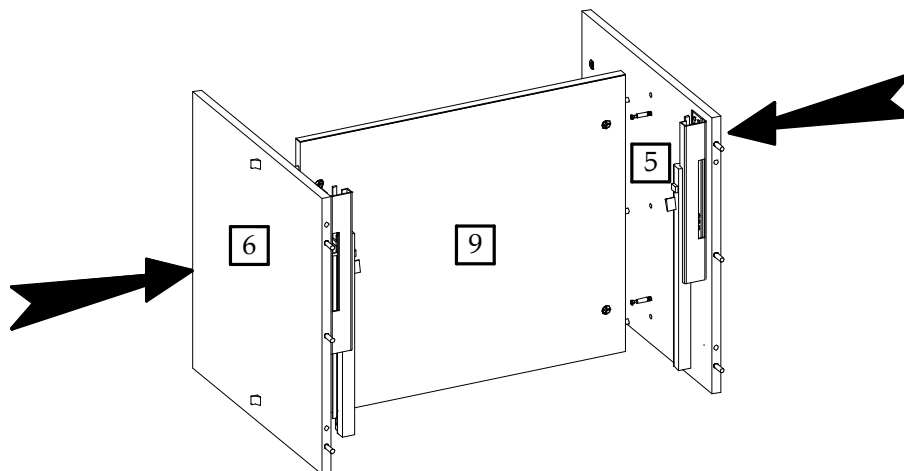
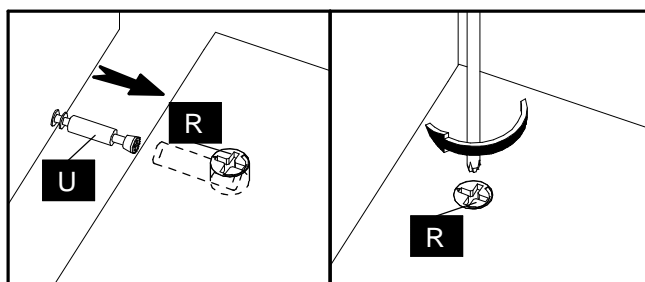

7

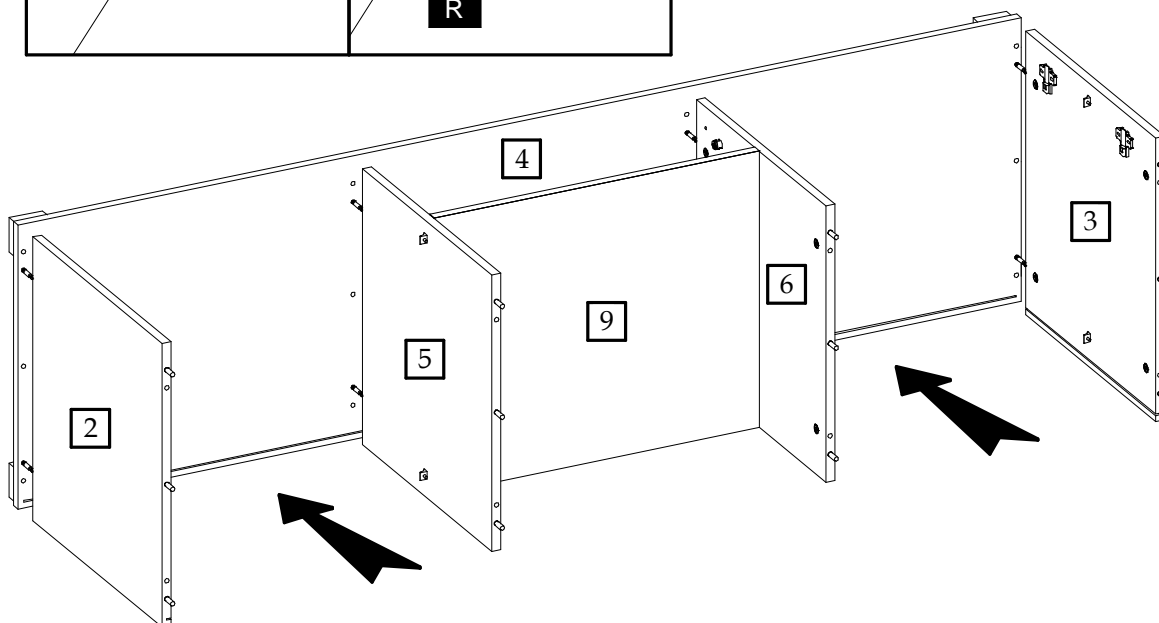
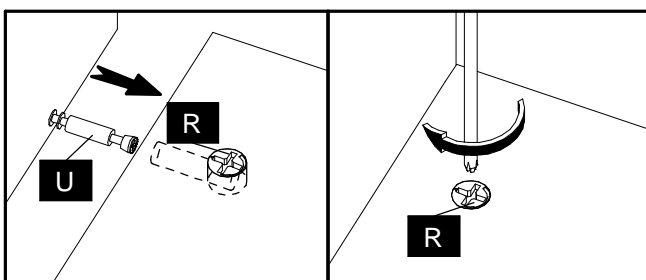

8

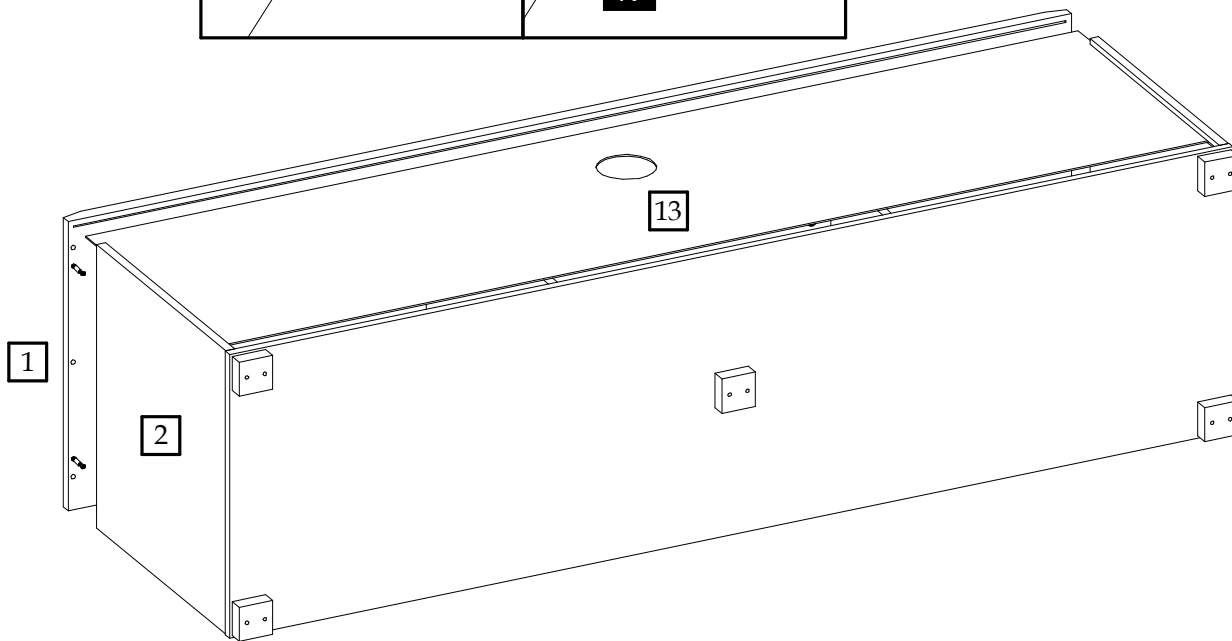
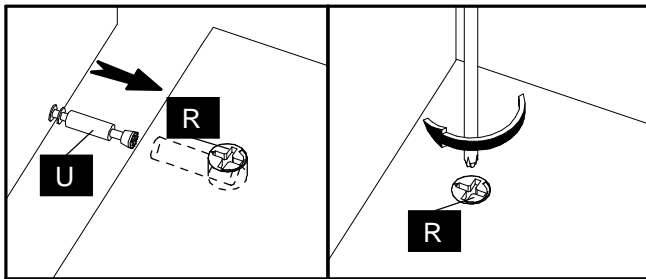

9

