

Camilla

Typ B

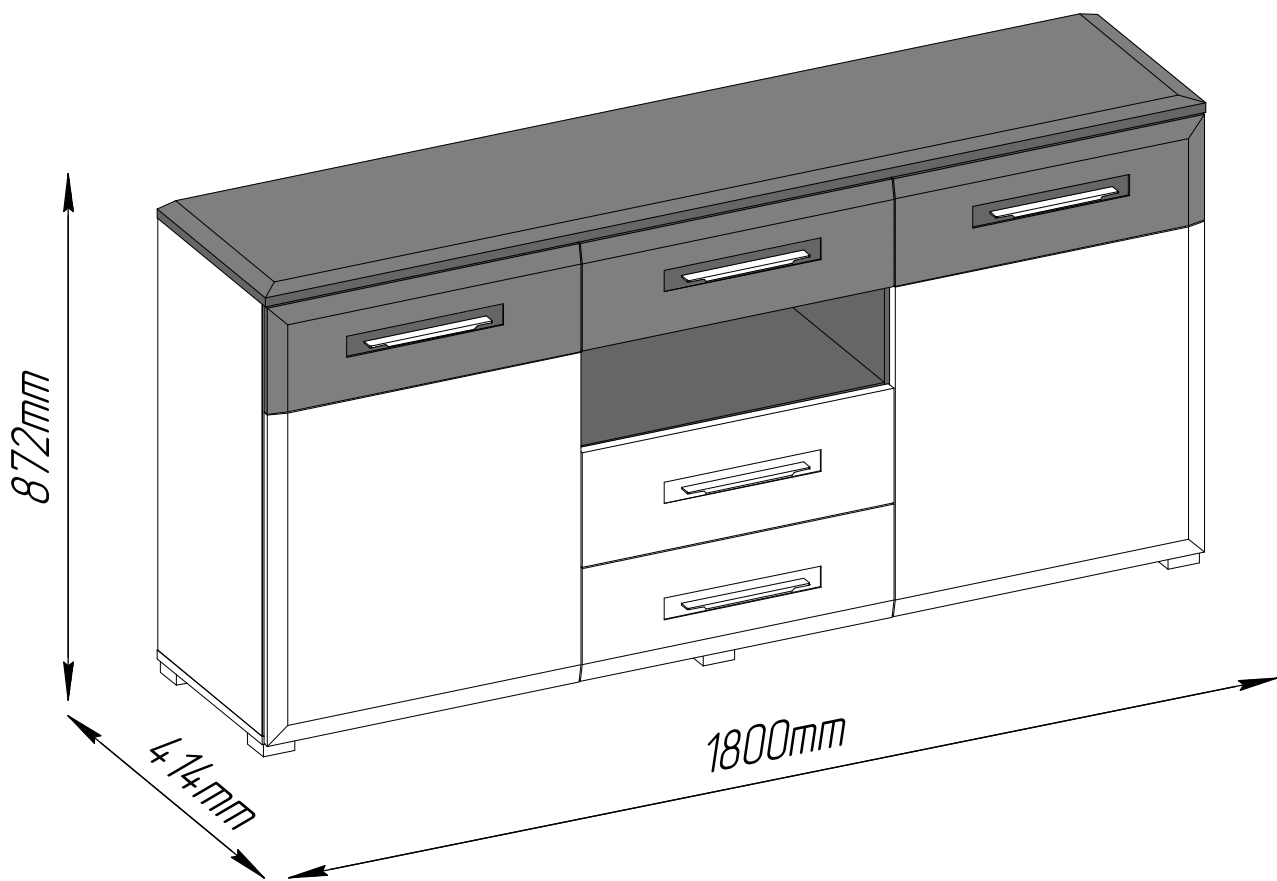

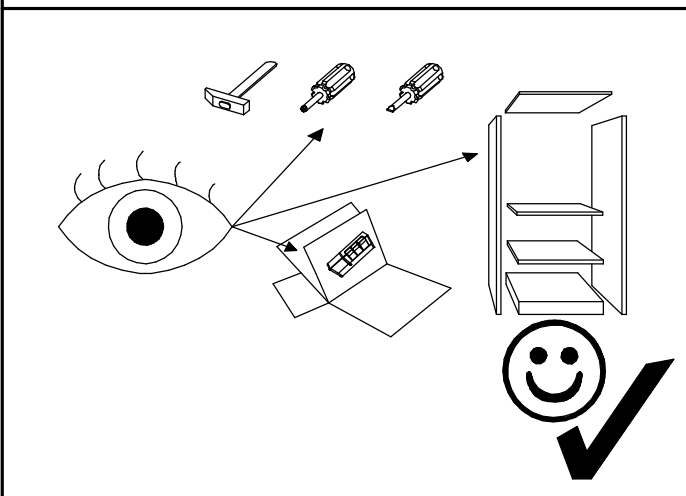

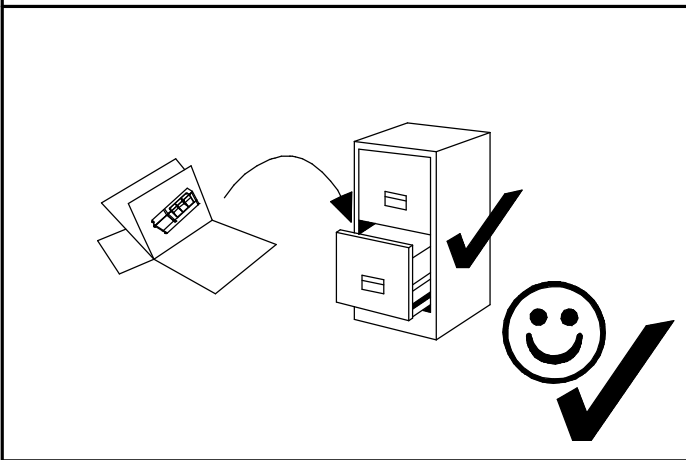
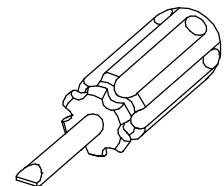
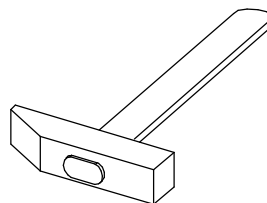
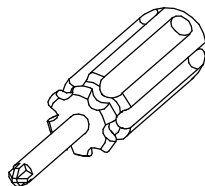
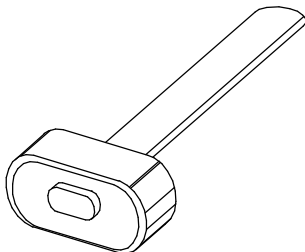
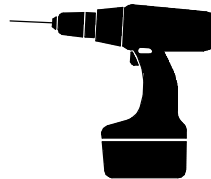
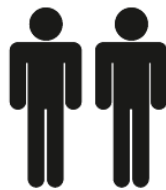
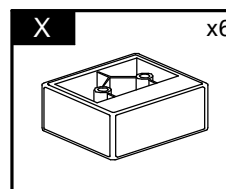
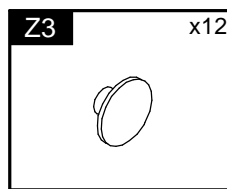
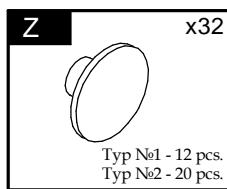
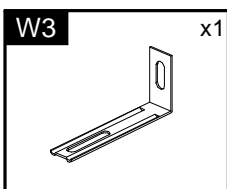
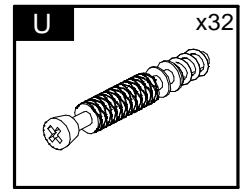
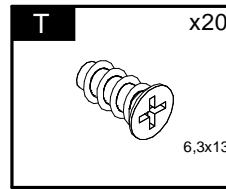
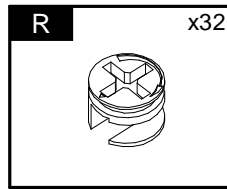
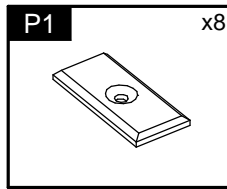
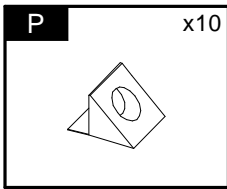
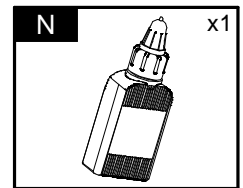
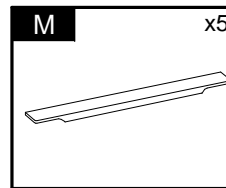
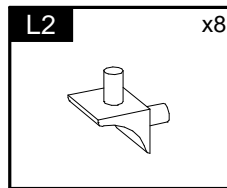
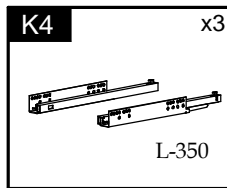
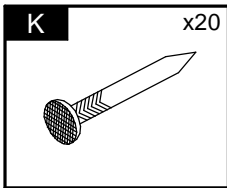
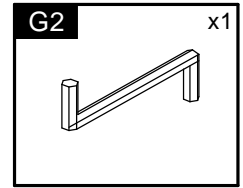
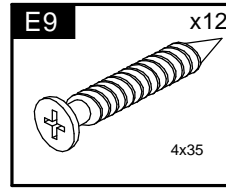
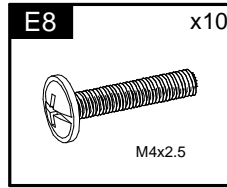
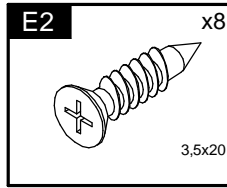
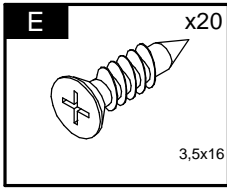
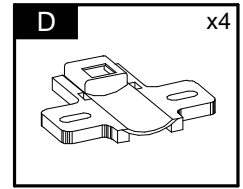
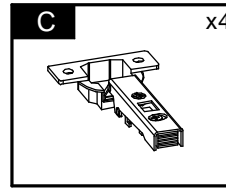
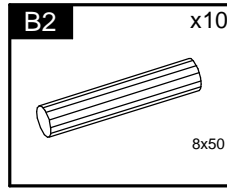
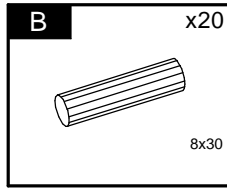
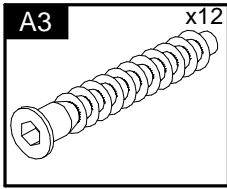

| Element symbol | Measurements | | | | Code | Paket |
|----------------|--------------|-------|----|---|------------|-------|
| 1 | 1801 | 415 | 19 | 1 | 1004_19mdf | 1/2 |
| 2 | 812 | 399.5 | 16 | 1 | 1001 | 1/2 |
| 3 | 812 | 399.5 | 16 | 1 | 1002 | 1/2 |
| 4 | 1800 | 400 | 16 | 1 | 1003 | 1/2 |
| 5 | 812 | 386.5 | 16 | 1 | 1008 | 1/2 |
| 6 | 812 | 386.5 | 16 | 1 | 1009 | 1/2 |
| 7 | 575.5 | 386 | 16 | 1 | 1006 | 1/2 |
| 8 | 575.5 | 386 | 16 | 1 | 1026 | 1/2 |
| 9 | 583 | 386 | 16 | 1 | 1020 | 1/2 |
| 10 | 340 | 120 | 16 | 1 | 1011 | 1/2 |
| 11 | 541 | 106.5 | 16 | 1 | 1012 | 1/2 |
| 12 | 340 | 120 | 16 | 1 | 1013 | 1/2 |
| 13 | 340 | 120 | 16 | 1 | 1016 | 1/2 |
| 14 | 541 | 106.5 | 16 | 1 | 1017 | 1/2 |
| 15 | 340 | 120 | 16 | 1 | 1018 | 1/2 |

| Element symbol | Measurements | | | | Code | Paket |
|----------------|--------------|-------|-----|---|----------|-------|
| 16 | 340 | 120 | 16 | 1 | 1022 | 1/2 |
| 17 | 541 | 106.5 | 16 | 1 | 1023 | 1/2 |
| 18 | 340 | 120 | 16 | 1 | 1024 | 1/2 |
| 19 | 826 | 590 | 2.5 | 2 | N/A | 2/2 |
| 20 | 826 | 598 | 2.5 | 1 | 1030_v | 2/2 |
| 21 | 551 | 345 | 2.5 | 1 | N/A | 2/2 |
| 22 | 551 | 345 | 2.5 | 1 | N/A | 2/2 |
| 23 | 551 | 345 | 2.5 | 1 | N/A | 2/2 |
| 24 | 597 | 200 | 22 | 1 | 3007_bhx | 2/2 |
| 25 | 624 | 597 | 22 | 1 | 3008_bhx | 2/2 |
| 26 | 597 | 200 | 22 | 1 | 3009_bhx | 2/2 |
| 27 | 624 | 597 | 22 | 1 | 3010_bhx | 2/2 |
| 28 | 597 | 200 | 22 | 1 | 3011_v | 2/2 |
| 29 | 597 | 216 | 22 | 1 | 3013_bhx | 2/2 |
| 30 | 597 | 216 | 22 | 1 | 3012_bhx | 2/2 |

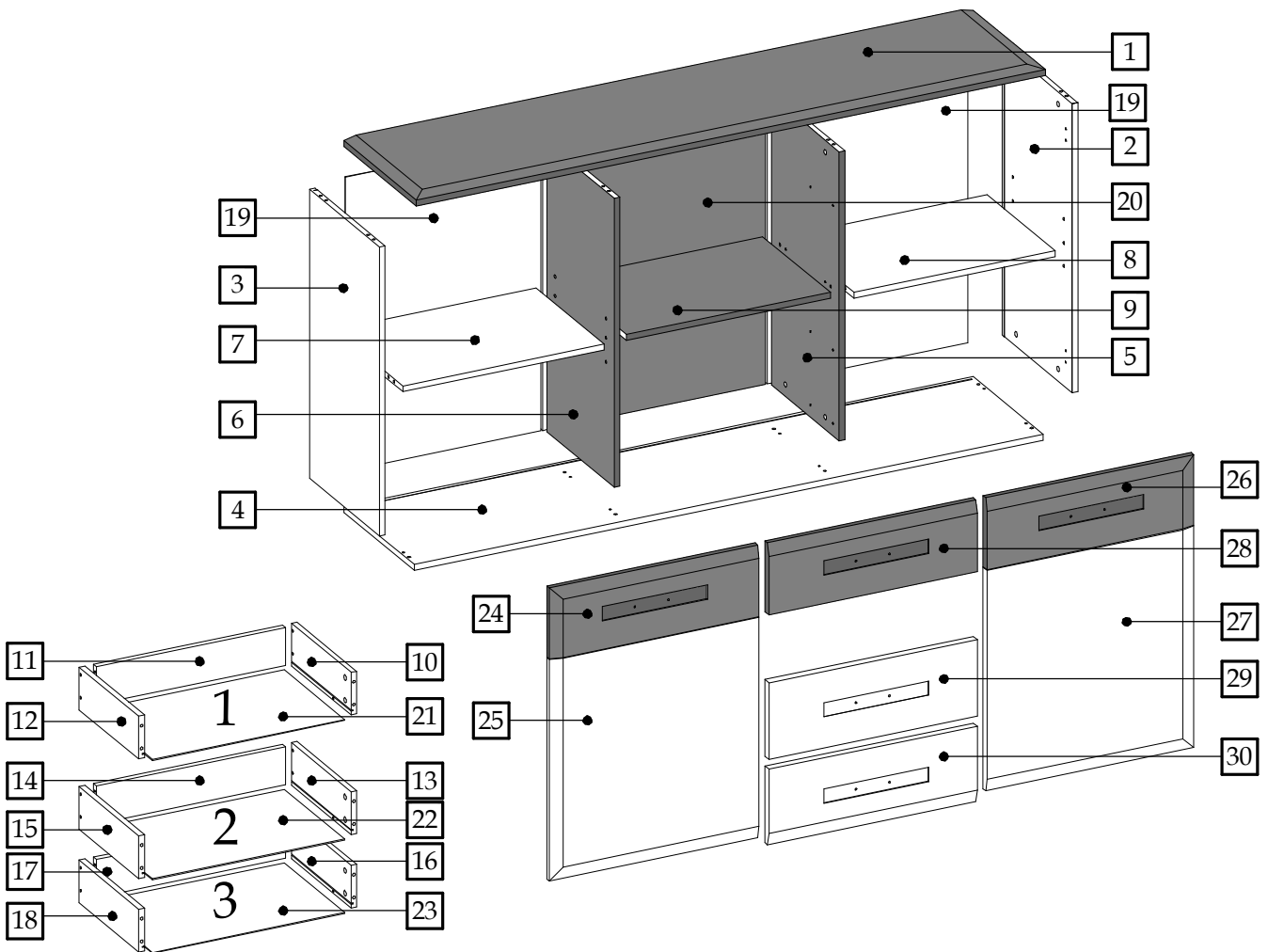



1

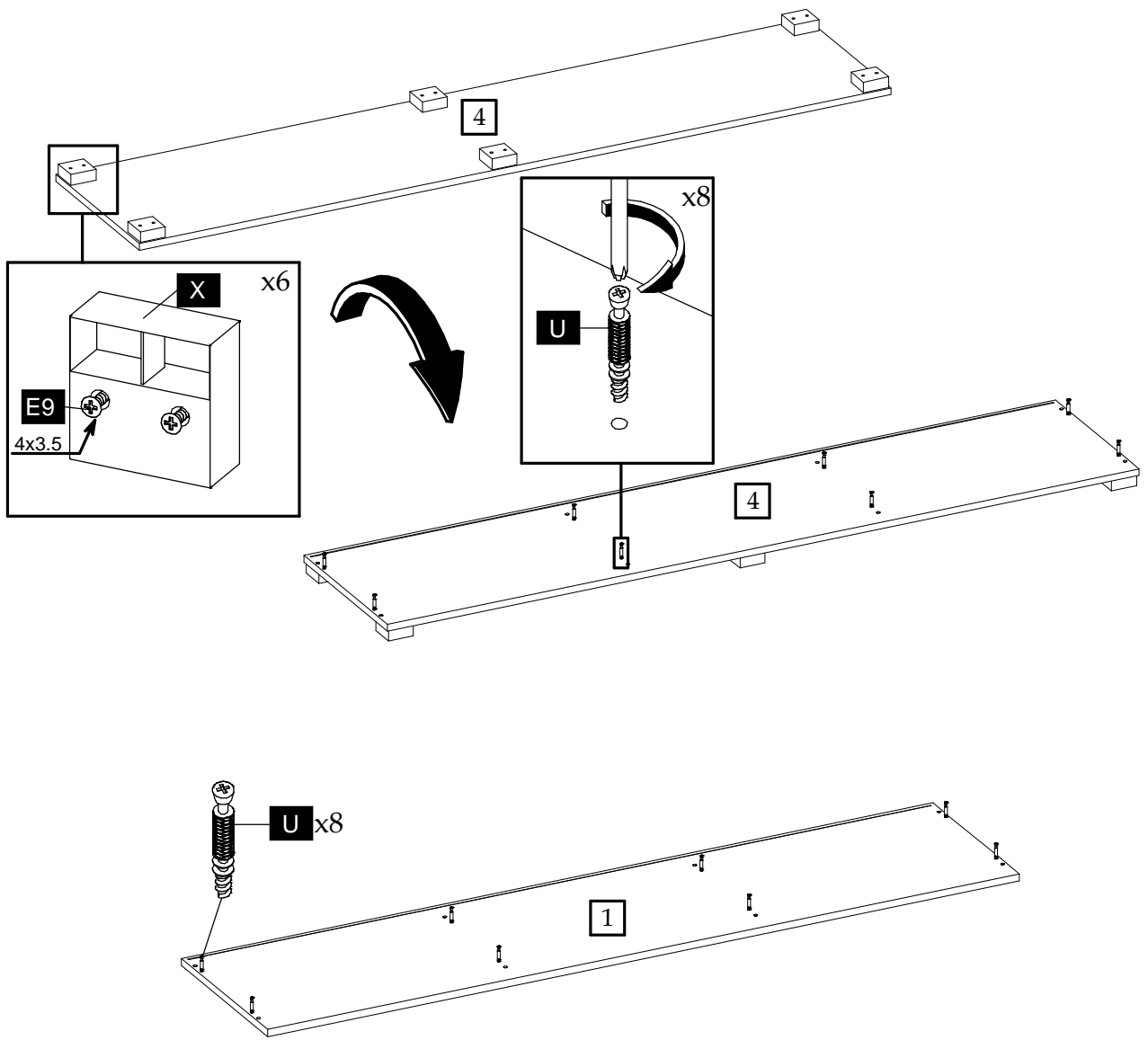

2

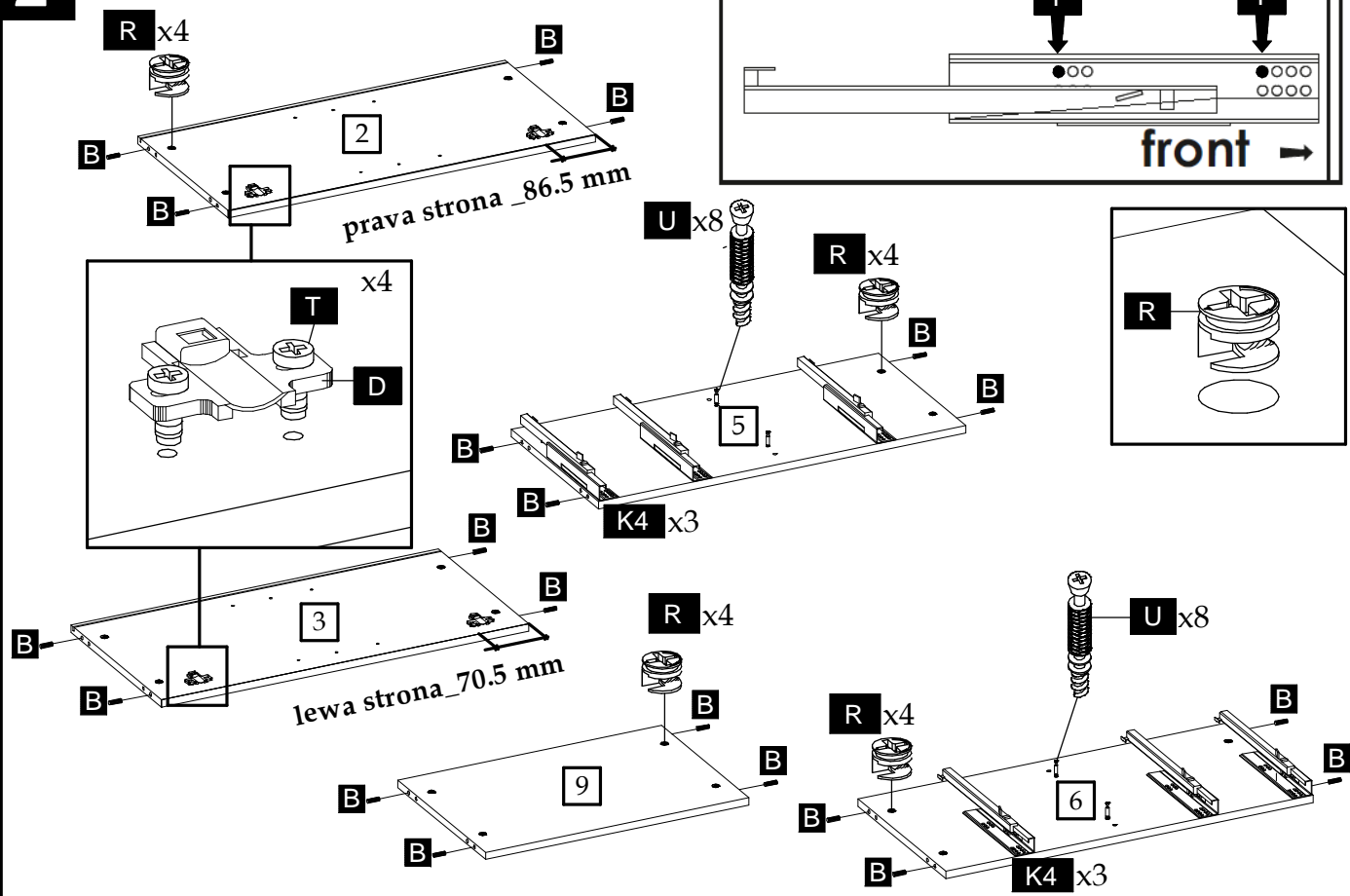

3

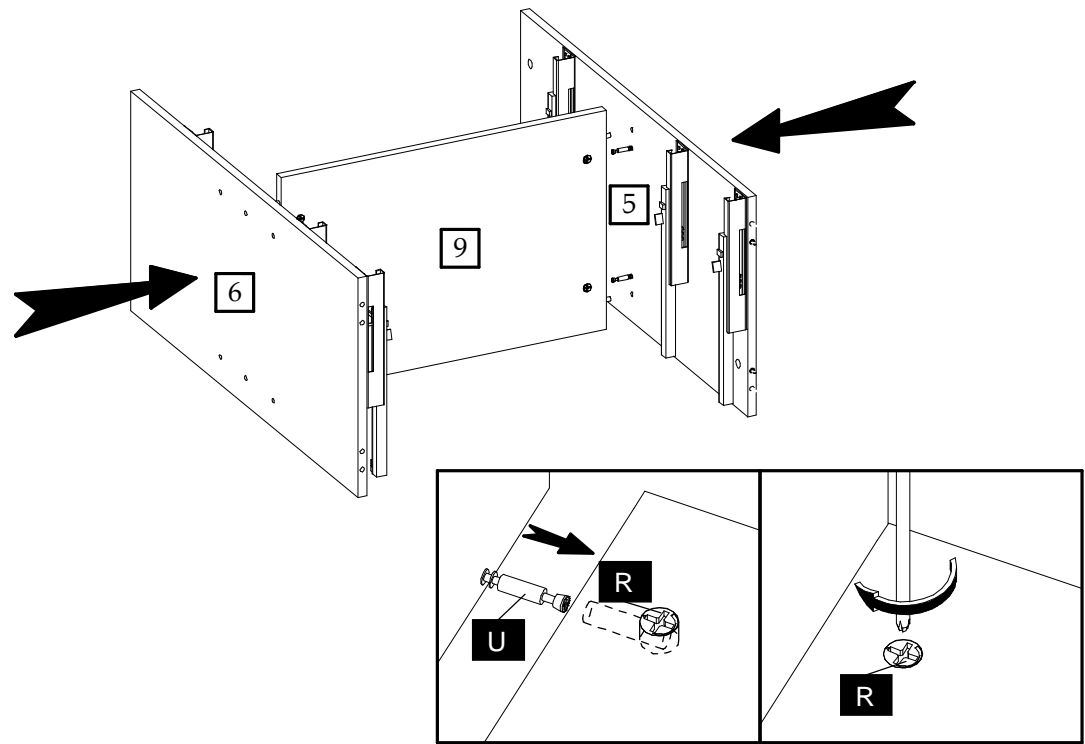

4

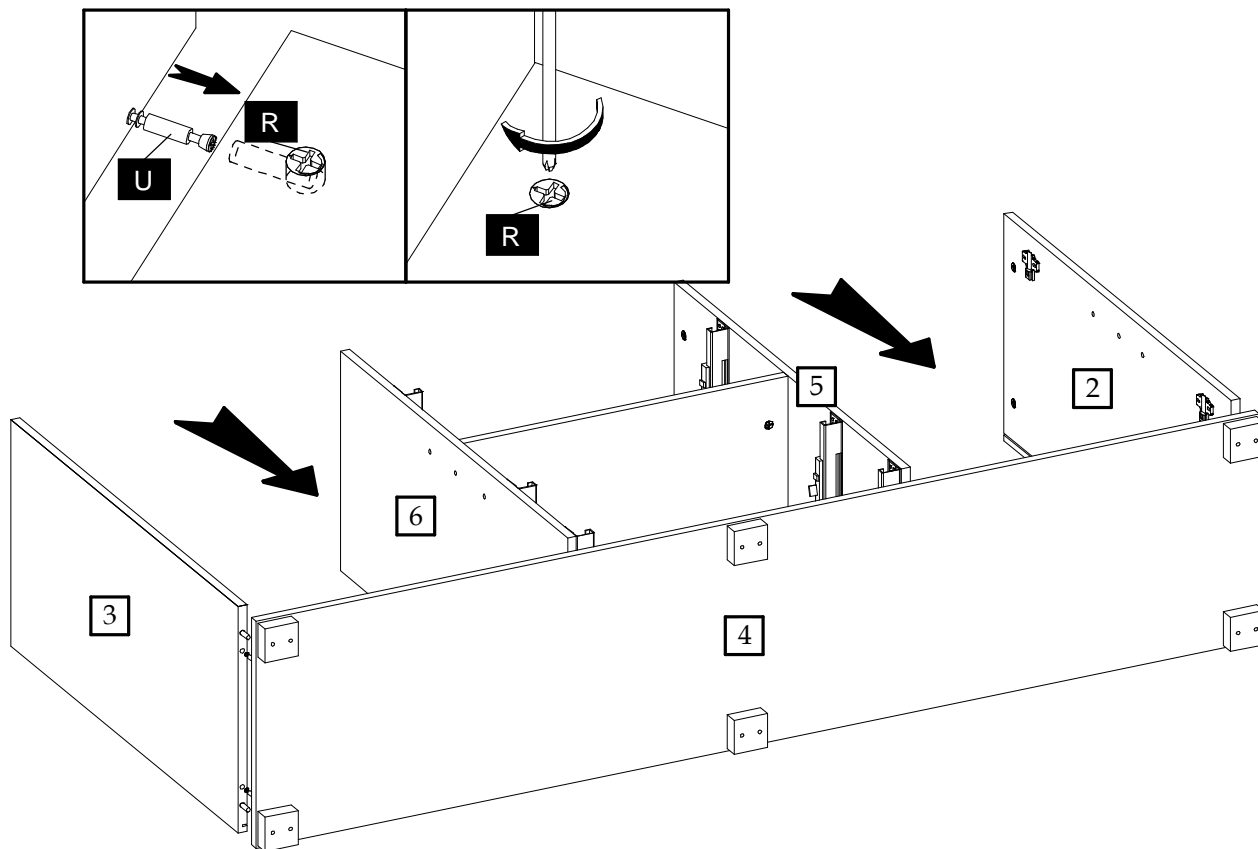

5

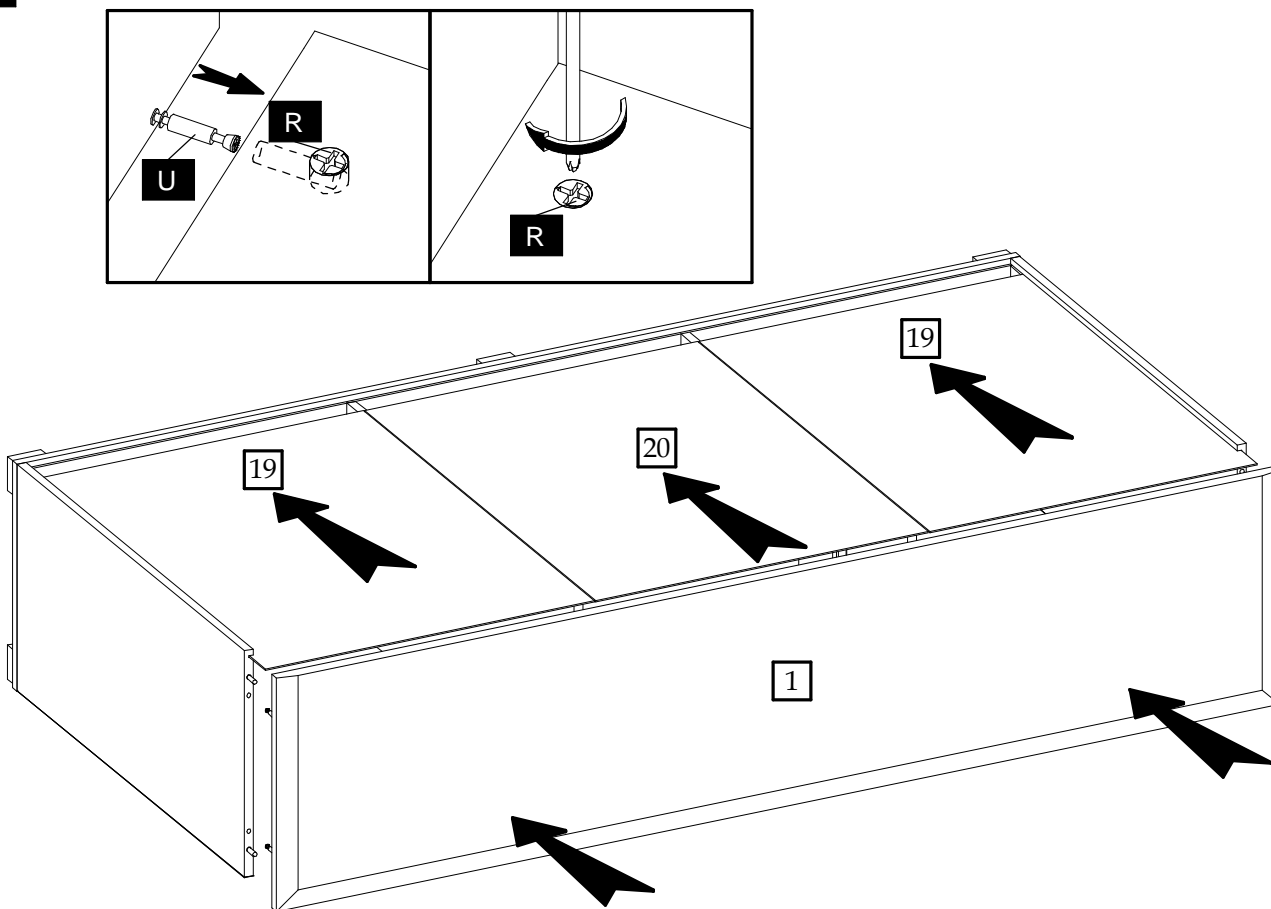

6

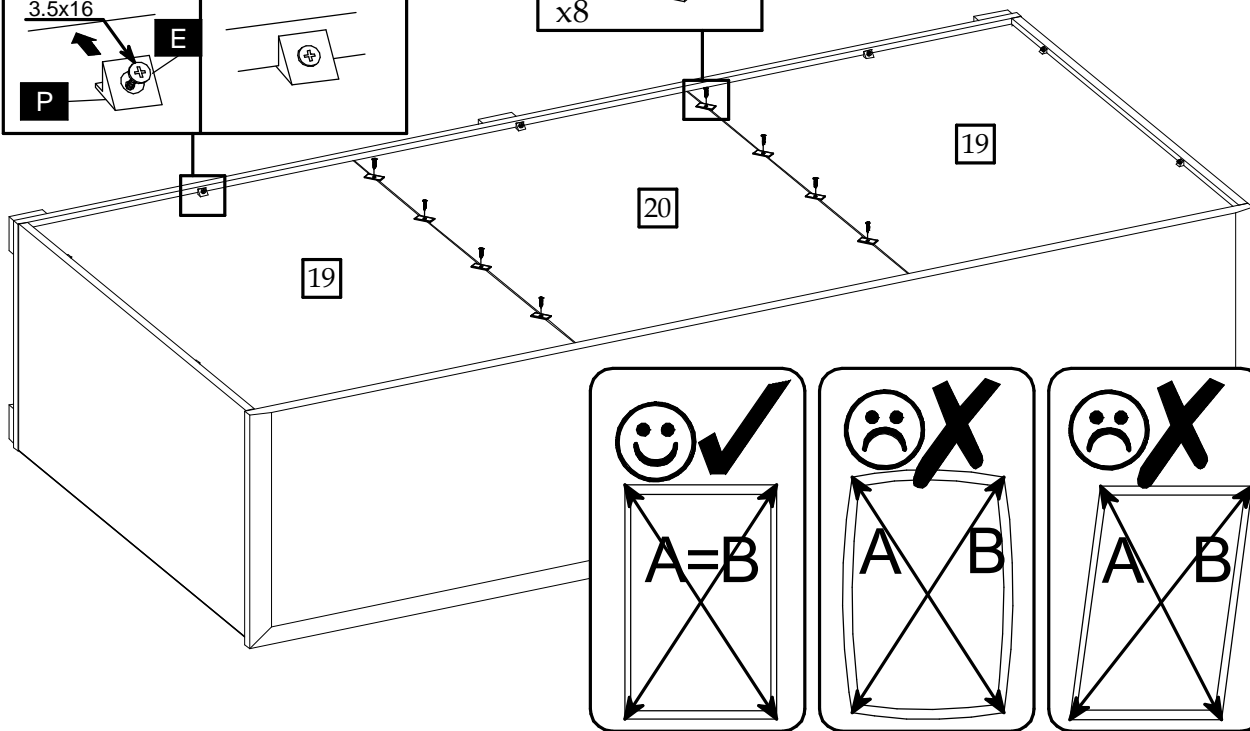
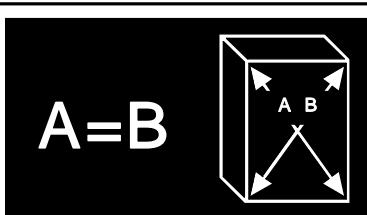
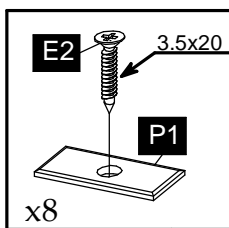
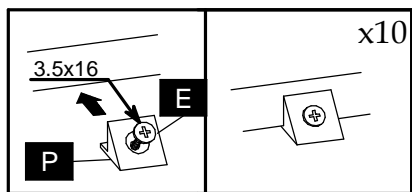

7

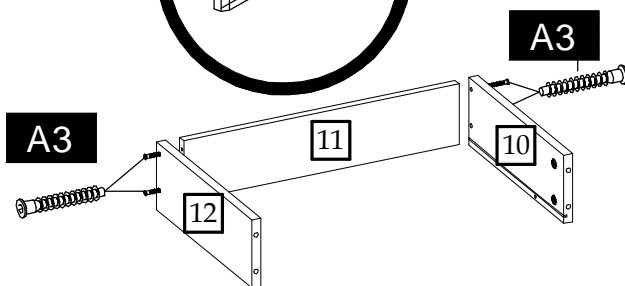
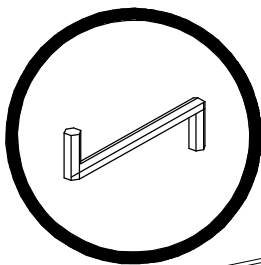
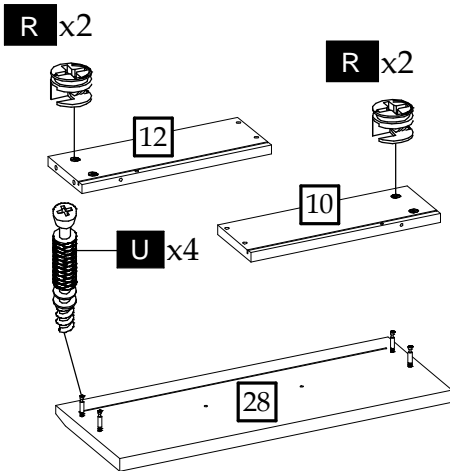

8

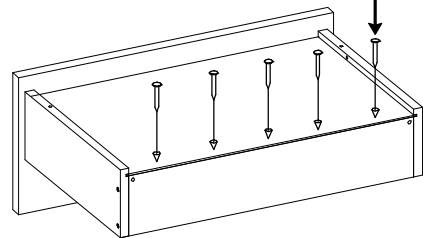
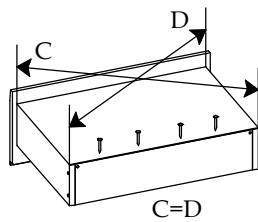
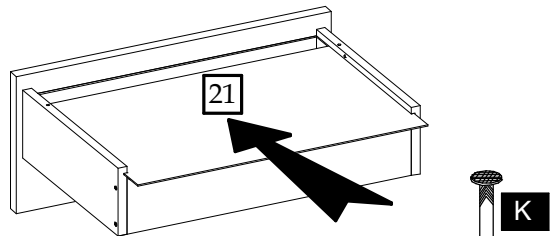
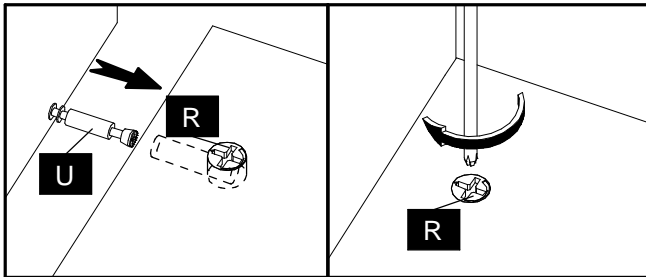
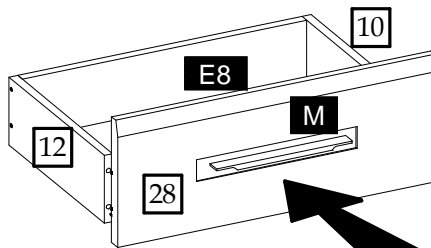
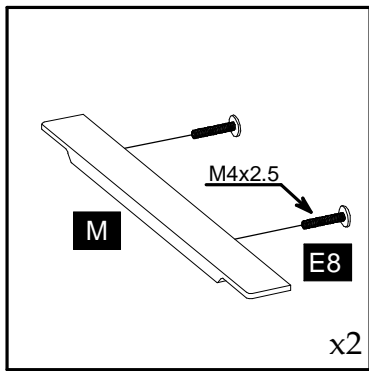

9

