

Camilla

Typ D

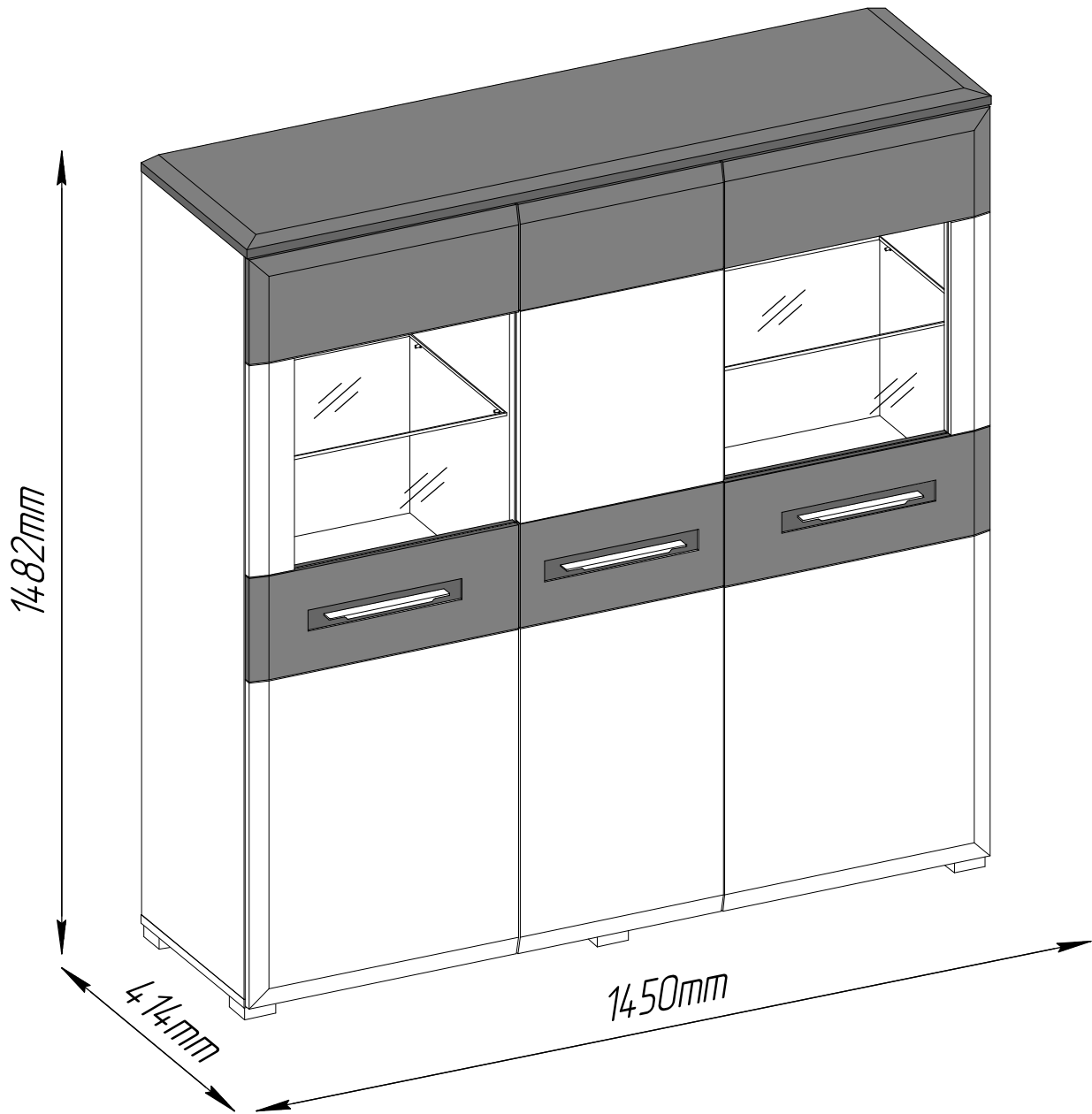

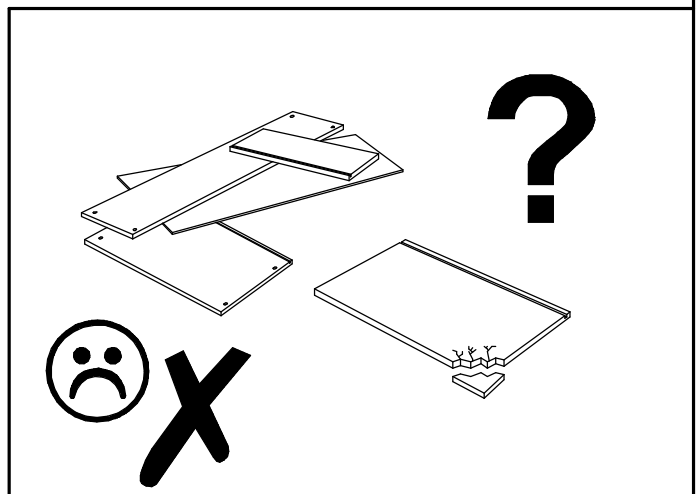

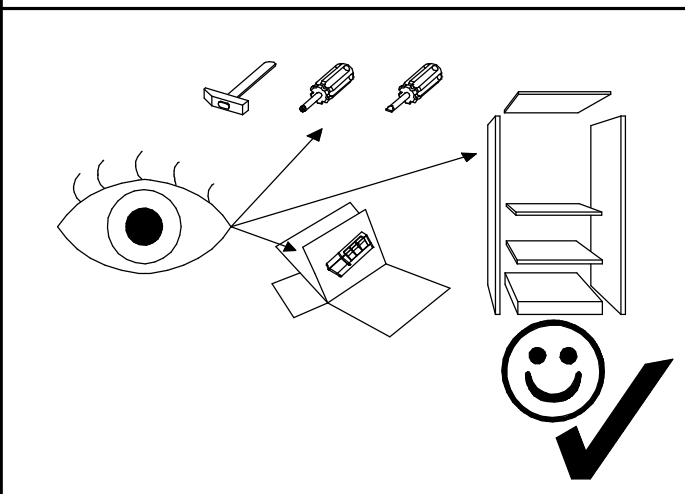
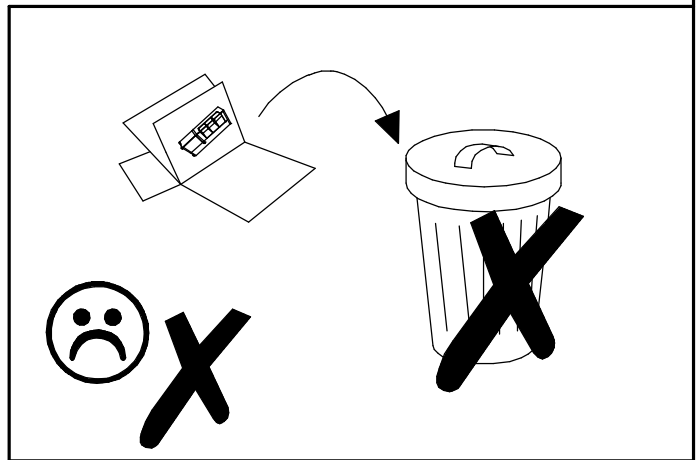
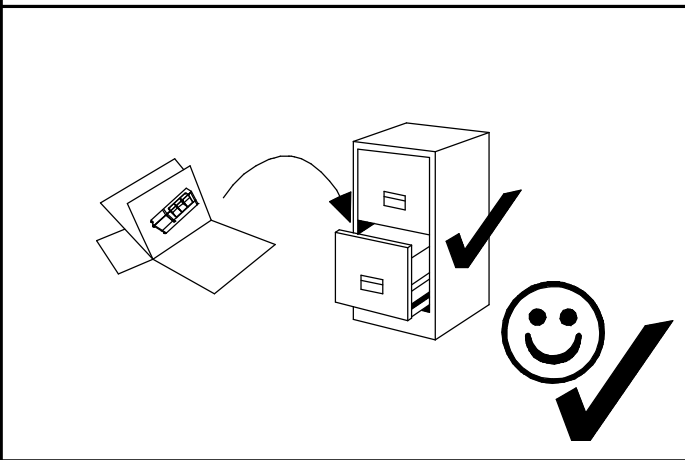
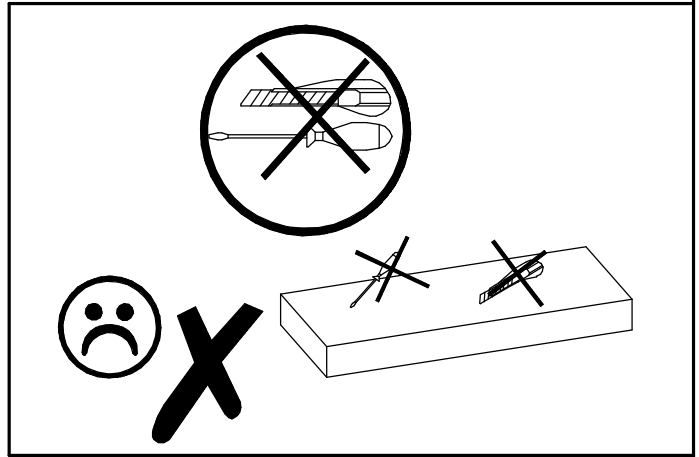
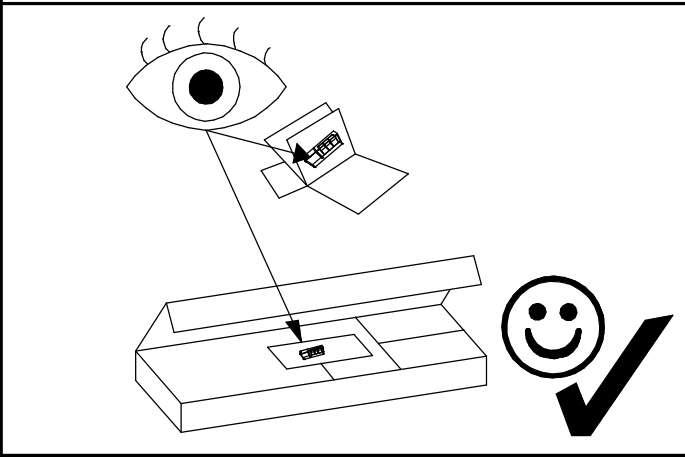
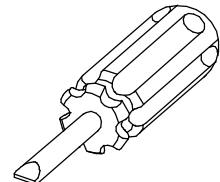
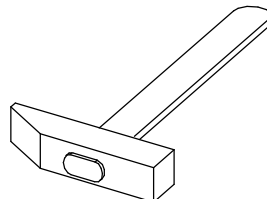
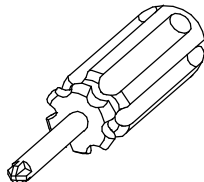
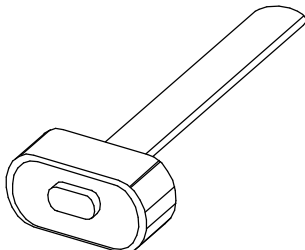
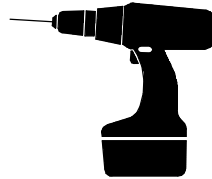
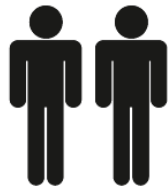
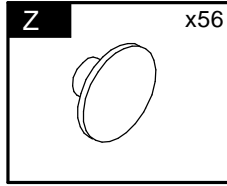
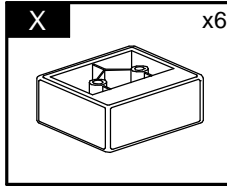
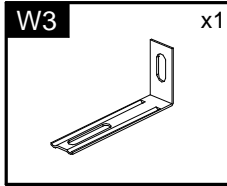
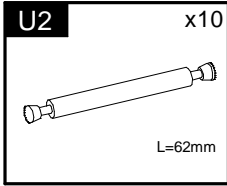
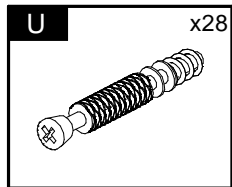
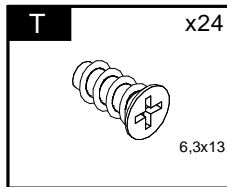
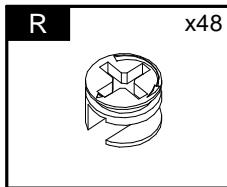
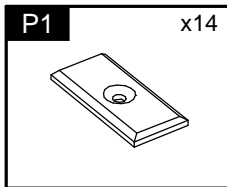
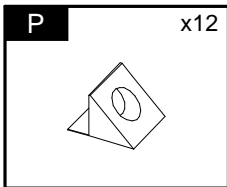
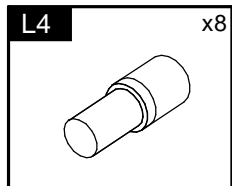
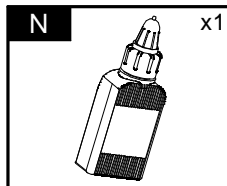
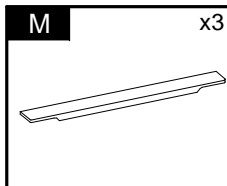
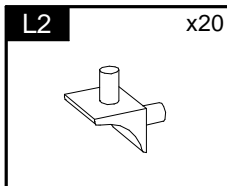
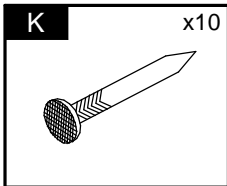
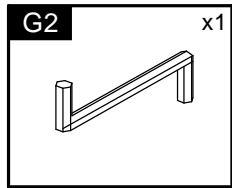
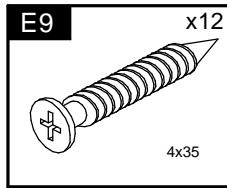
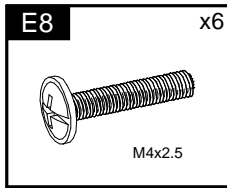
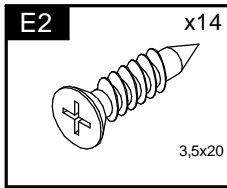
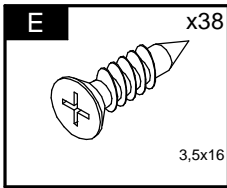
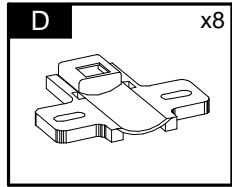
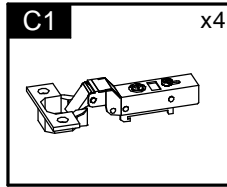
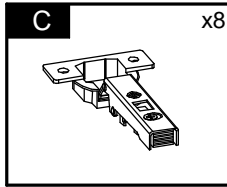
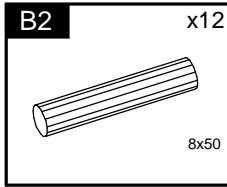
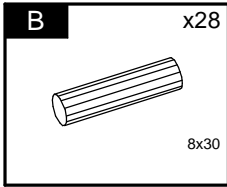
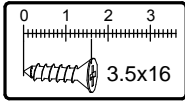
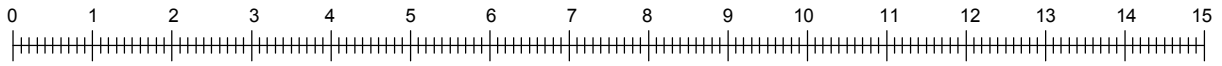

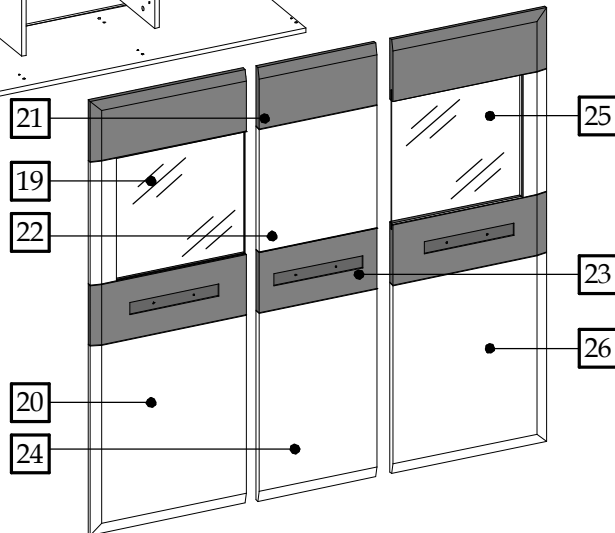
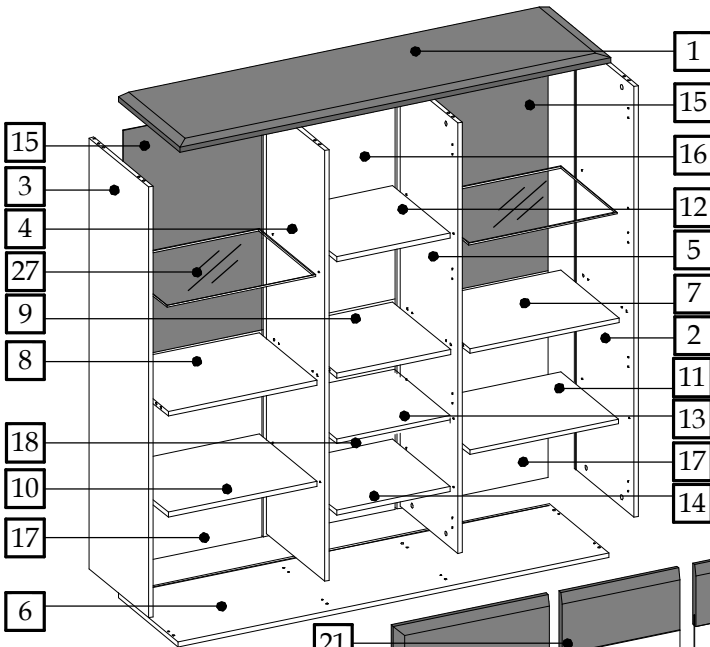
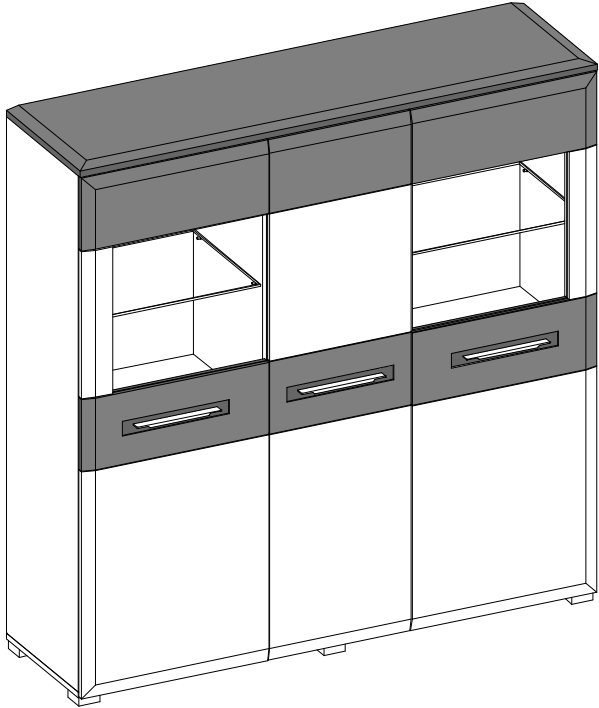

Element symbol	Measurements				Code	Paket
	W	H	T	Gr		
1	1451	415	19	1	1005_19mdf	2/5
2	1422	399.5	16	1	1002	2/5
3	1422	399.5	16	1	1003	2/5
4	1422	386.5	16	1	1012	1/3
5	1422	386.5	16	1	1011	1/3
6	1450	400	16	1	1004	2/5
7	500.5	386	16	1	1007	1/3
8	500.5	386	16	1	1018	1/3
9	383	386	16	1	1013	1/3
10	500.5	386	16	1	1006	1/3
11	500.5	386	16	1	1008	1/3
12	383	386	2.5	1	1009	3/3
13	383	386	2.5	1	1010	1/3
14	383	386	2.5	1	1014	1/3
15	514	788	2.5	2	N/A	4/5
16	397	767	2.5	1	1031_v	2/5
17	514	647	2.5	2	N/A	4/5
18	397	667	2.5	1	N/A	2/5
19	811	522	22	1	Doors with glass	4/5
20	624	522	22	1	3024_bhx	3/5
21	397	200	22	1	3011_bhx	3/5
22	411	397	22	1	3012_bhx	3/5
23	397	200	22	1	3013_bhx	3/5
24	624	397	22	1	3014_bhx	3/5
25	811	522	22	1	Doors with glass	4/5
26	624	522	22	1	3004_bhx	3/5
27	450	460	6	2	Glass	5/5

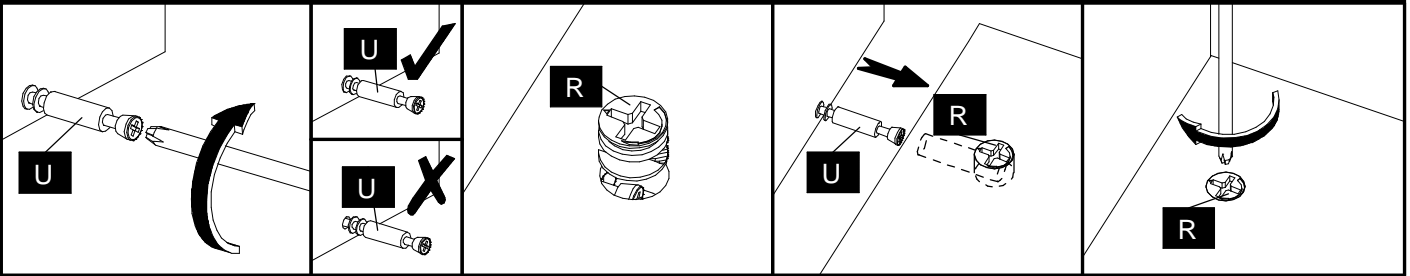

1

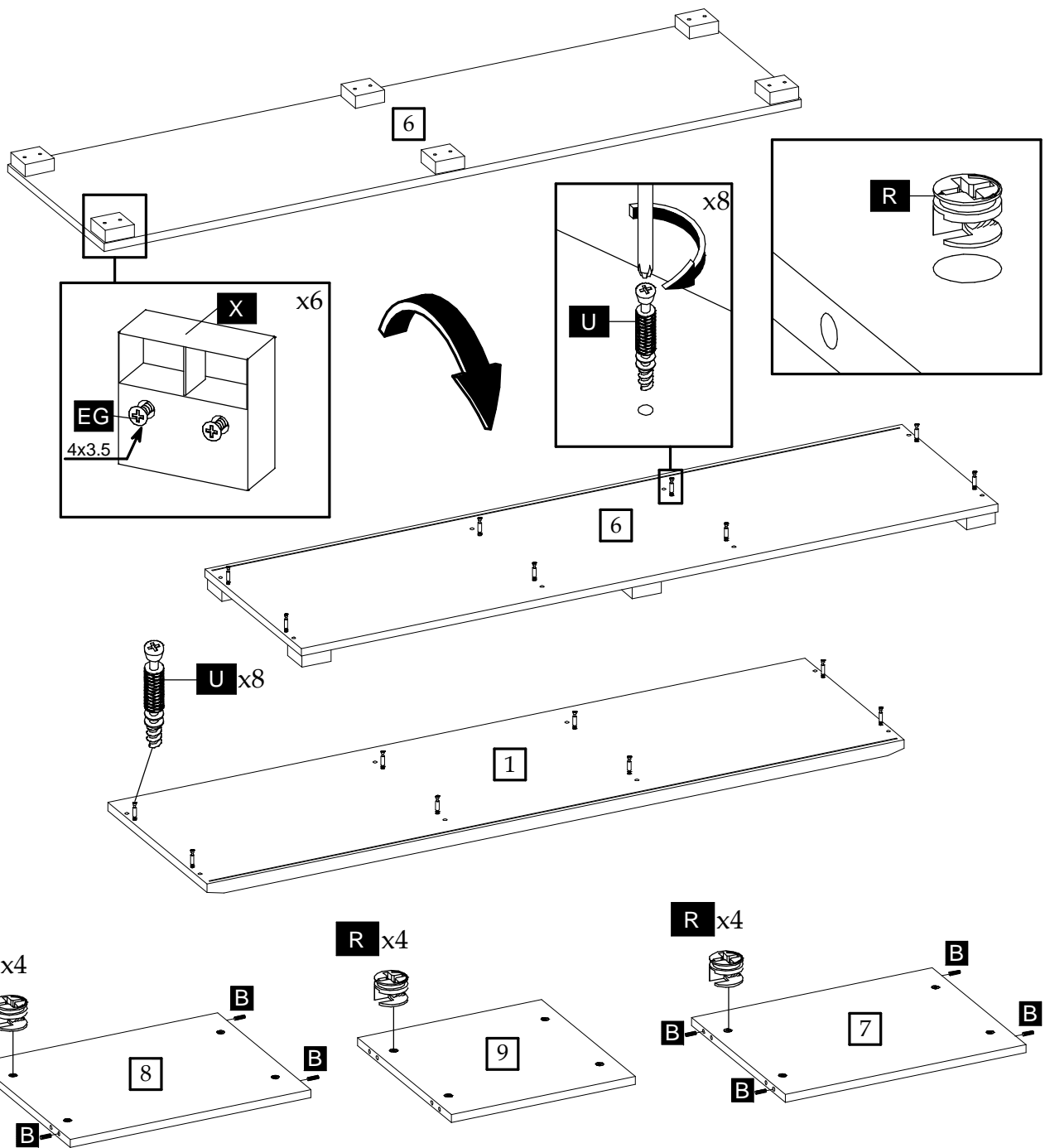

2

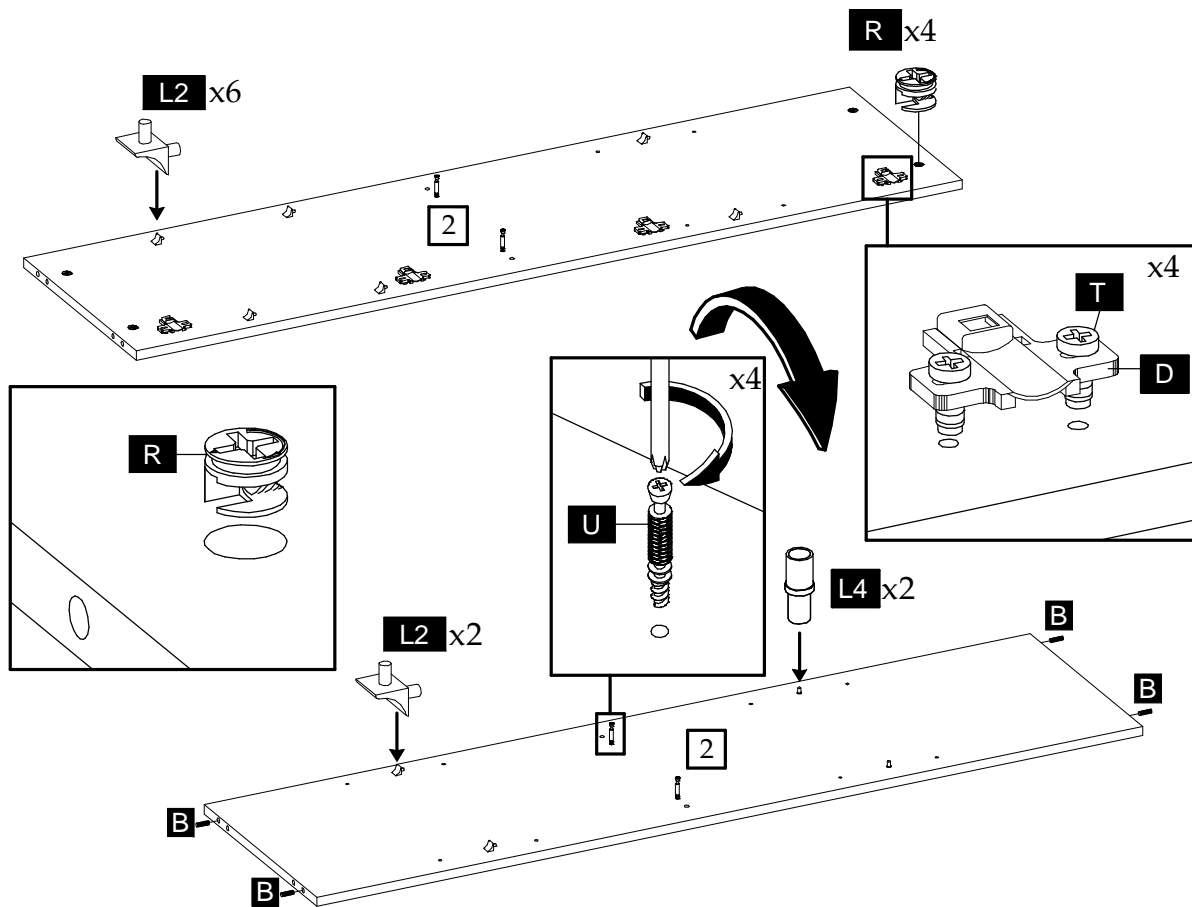

3

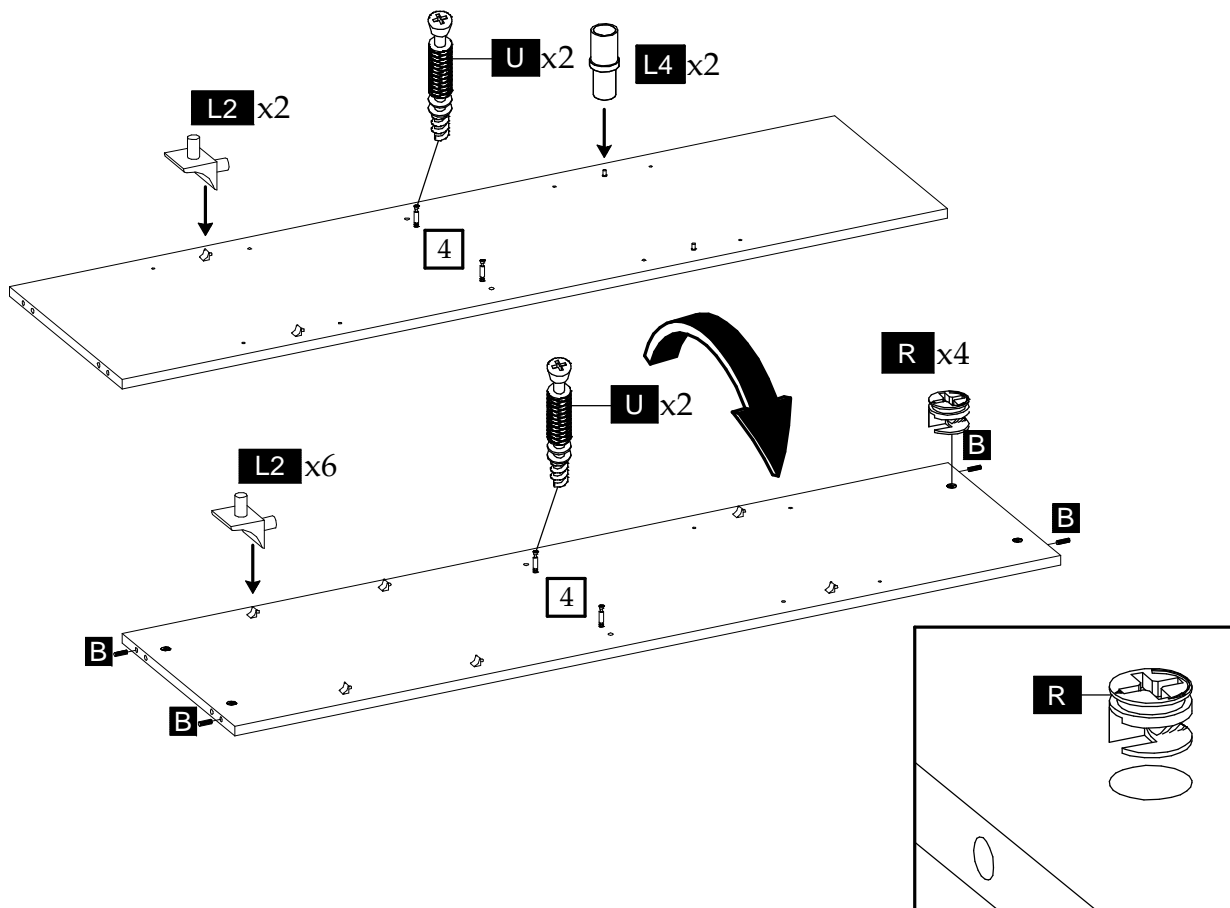

4

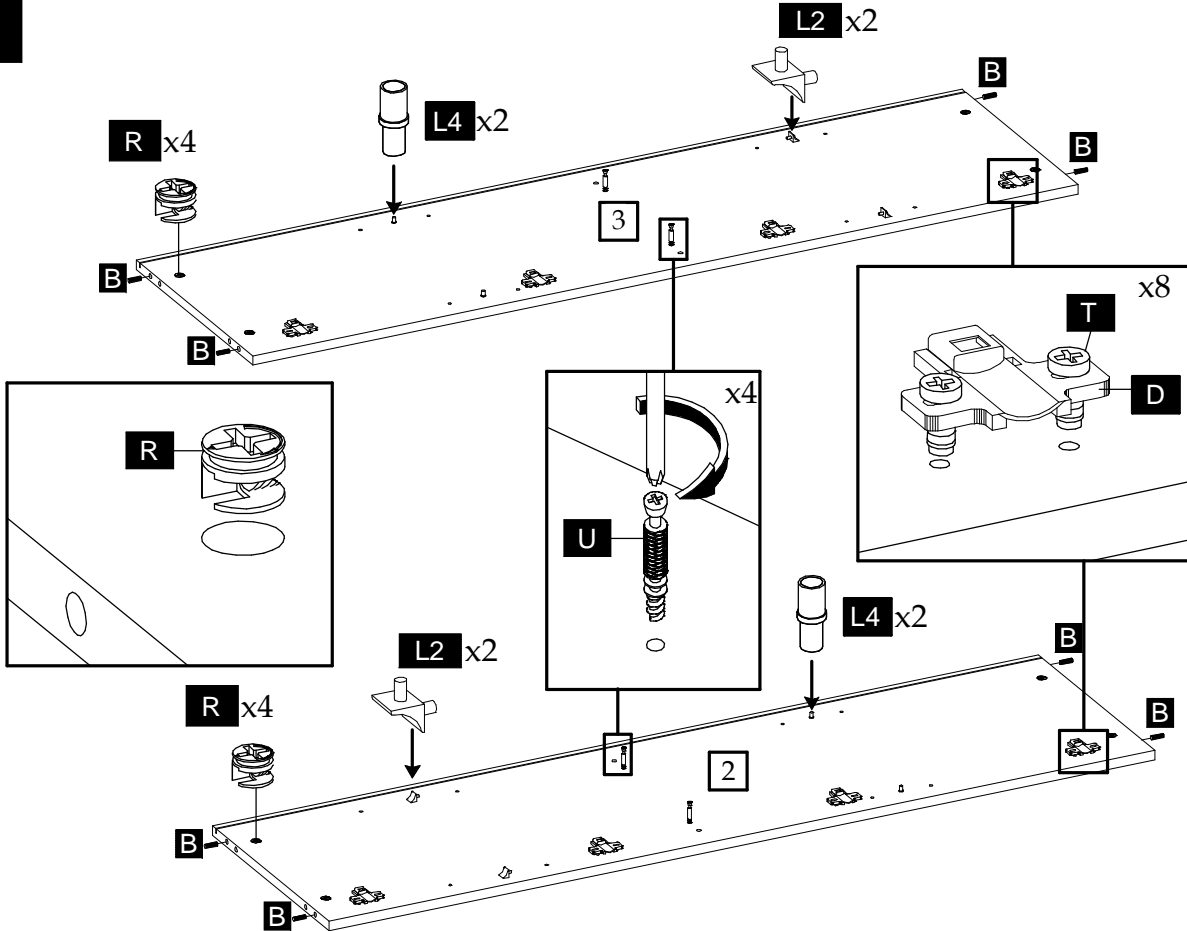

5

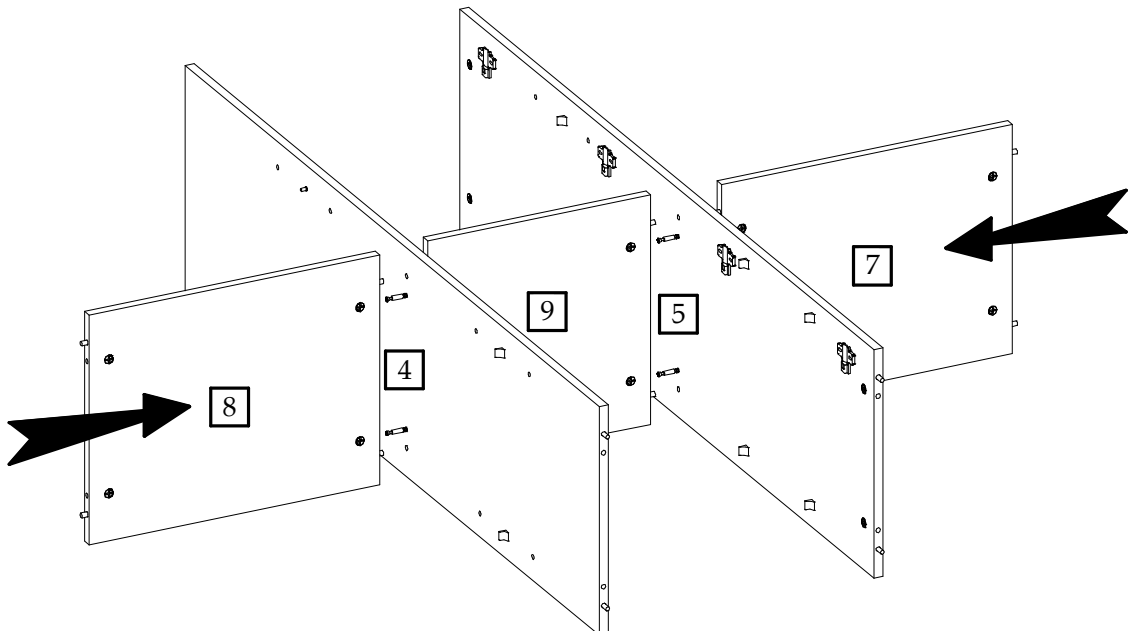
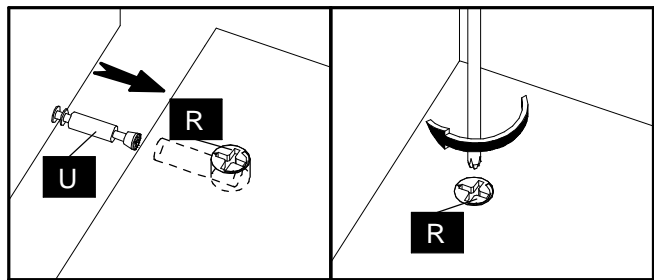

6

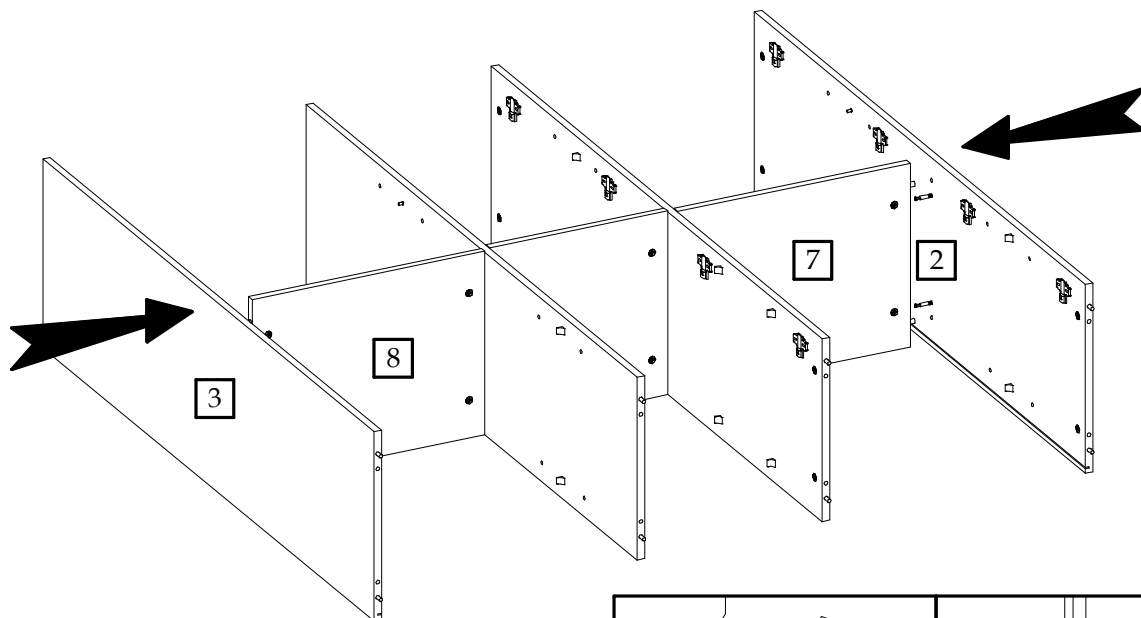

7

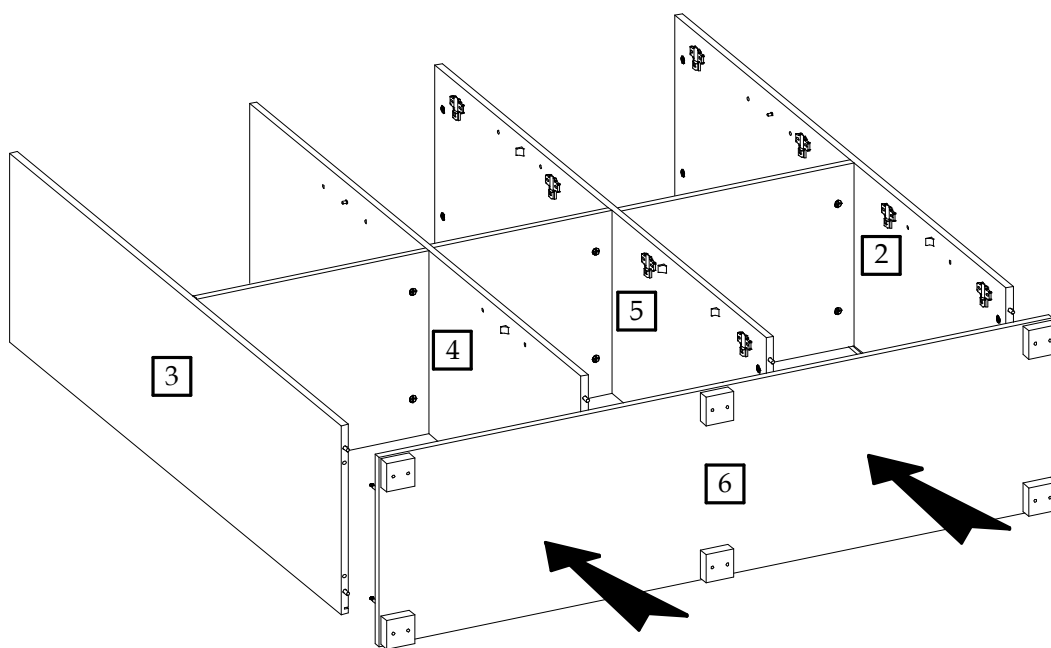

8

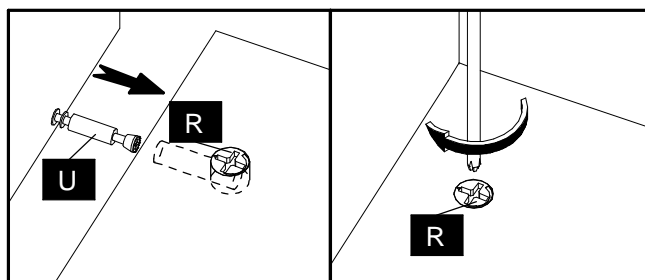
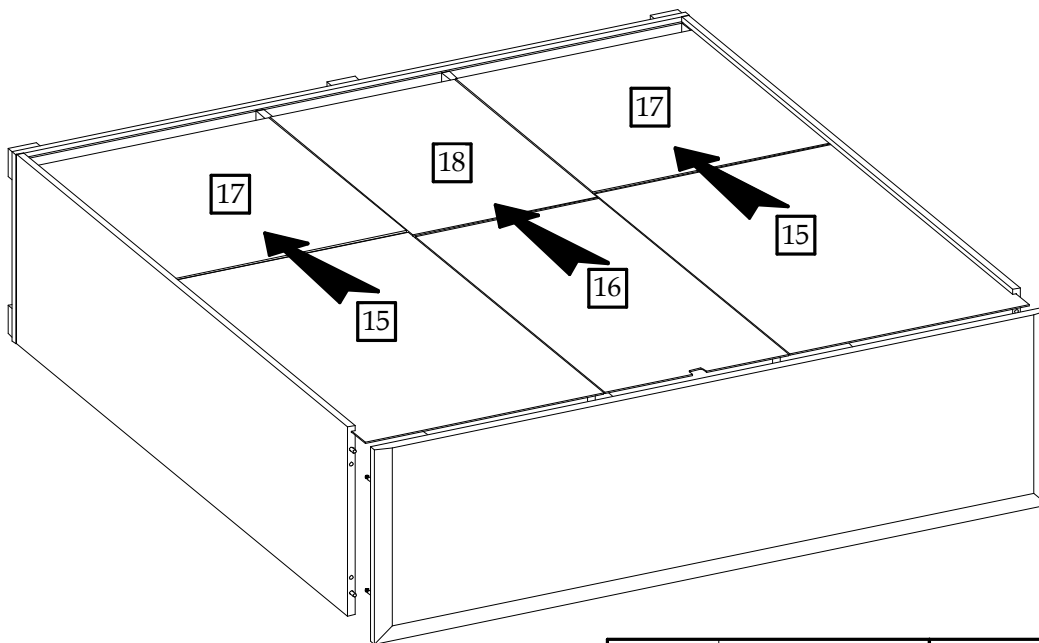

9

