

RODAN

Typ E

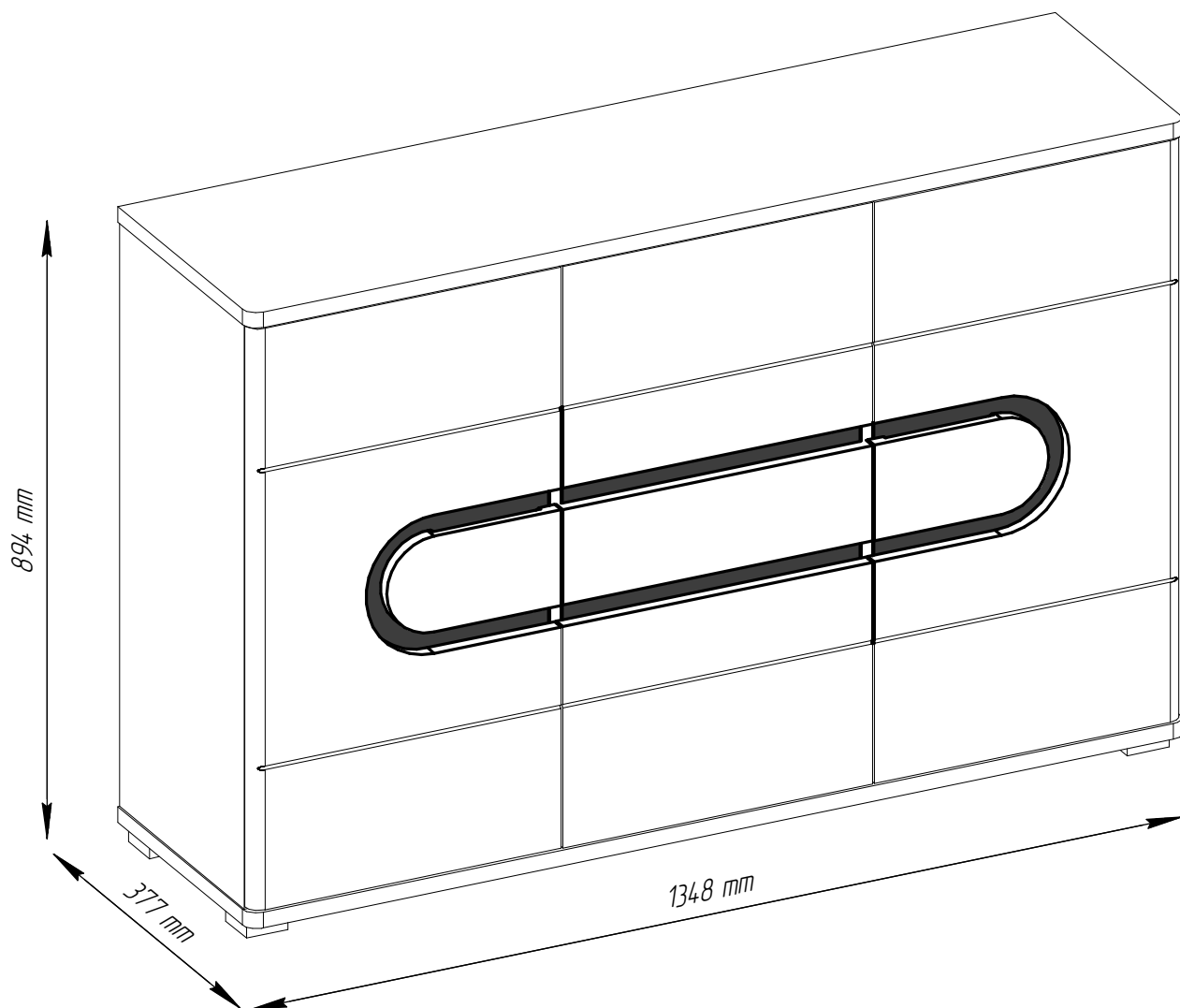

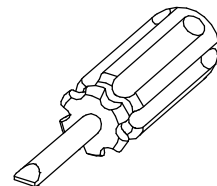

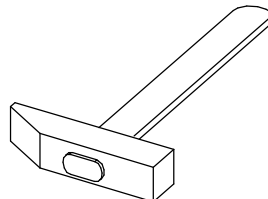
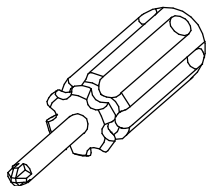
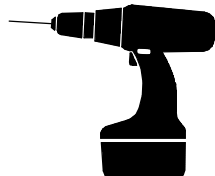
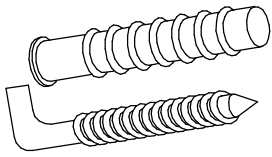
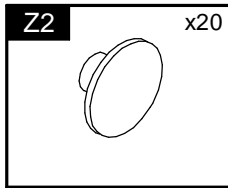
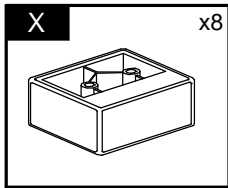
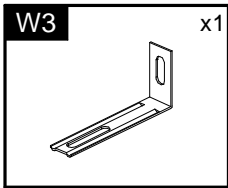
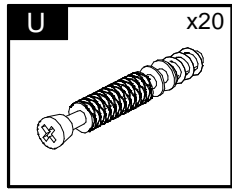
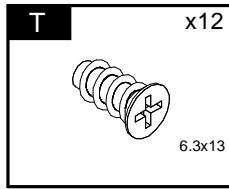
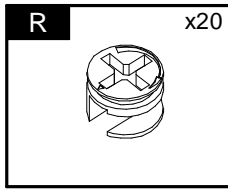
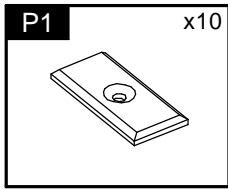
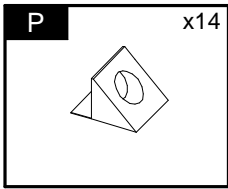
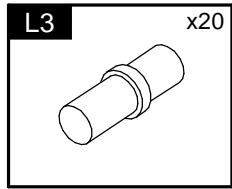
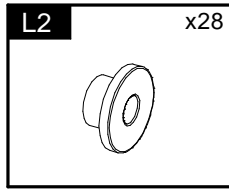
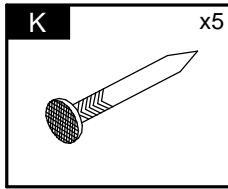
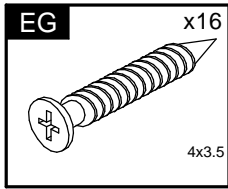
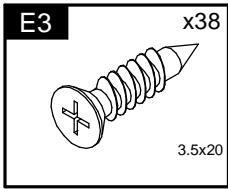
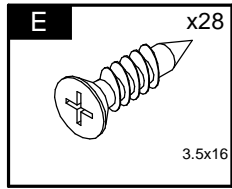
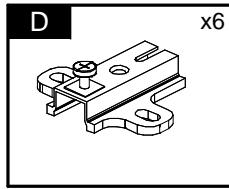
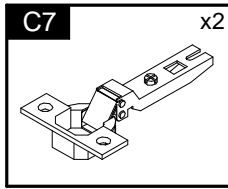
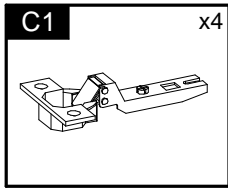
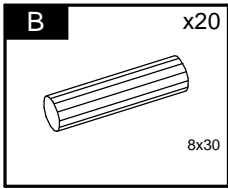

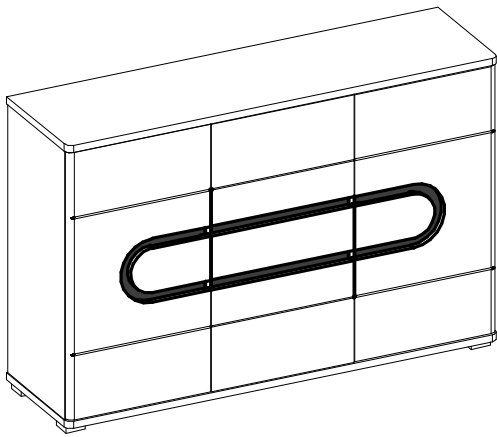

Element symbol	Measurements				Code	Paket
1	1348	377	22	1	1002	1/4
2	1348	377	22	1	1003	1/4
3	825	357	16	1	1004	2/4
4	825	357	16	1	1005	2/4
5	825	337	16	1	1006	2/4
6	825	337	16	1	1007	2/4
7	432	331	16	1	1001	1/4
8	423	325	16	4	N/A	1/4
9	432	325	16	1	N/A	1/4
10	839	438	3	2	N/A	3/4
11	839	448	3	1	N/A	3/4
12	819	444	19	2	3024	3/4
13	444	312	19	1	3015	3/4
14	444	312	19	1	3017	3/4
15	444	135	19	1	3019	3/4
16	250	135	19	2	3026	3/4
17	285	250	4	2	N/A	4/4
18	428	250	4	1	N/A	4/4

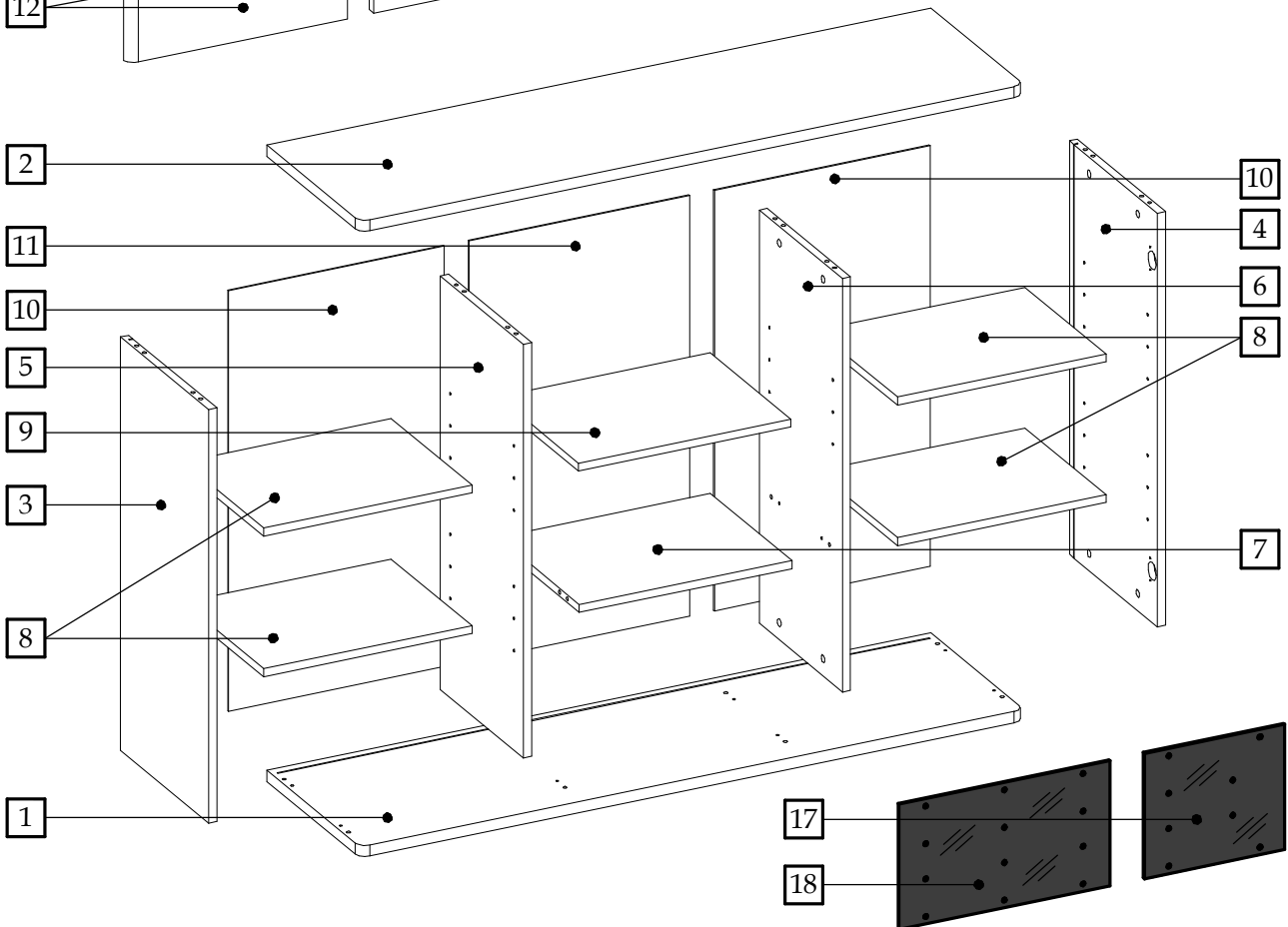
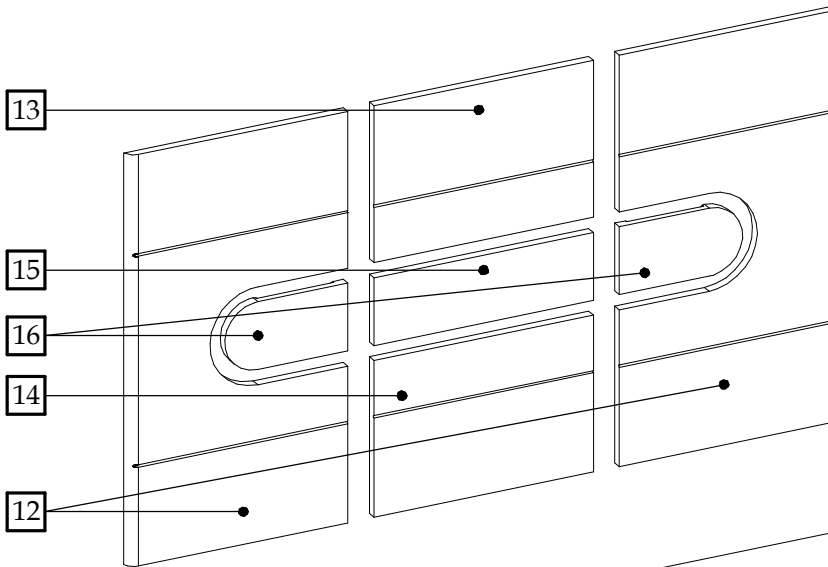

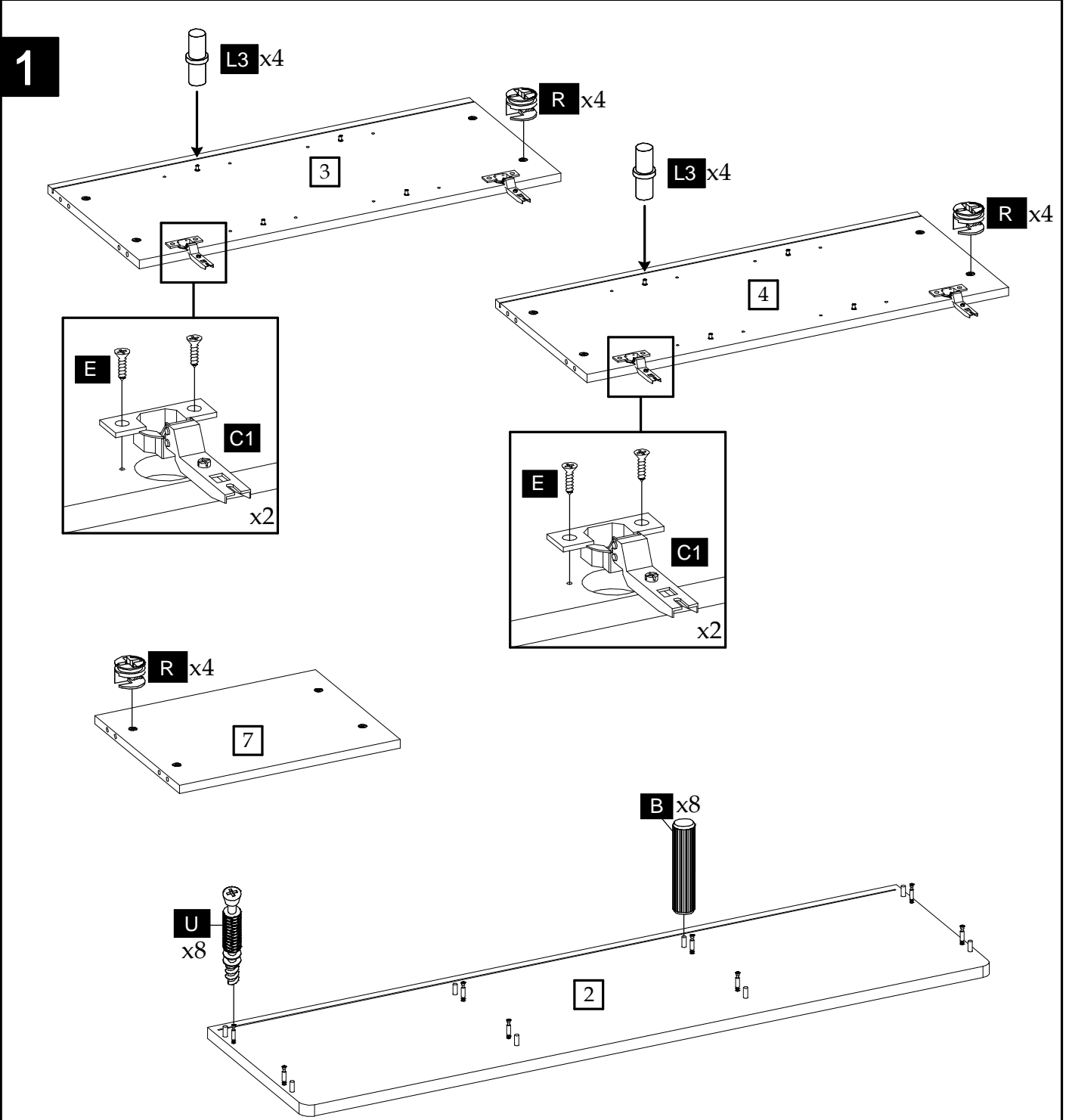

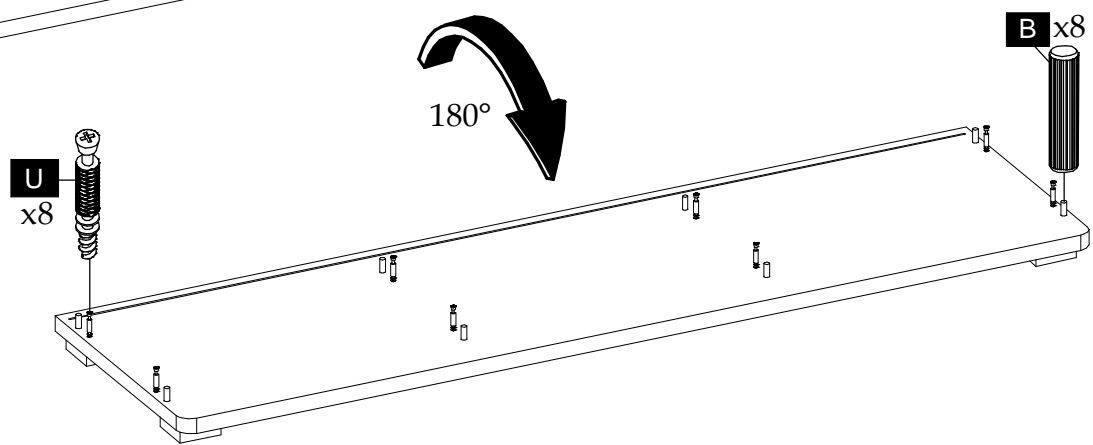
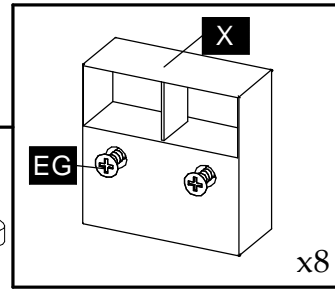
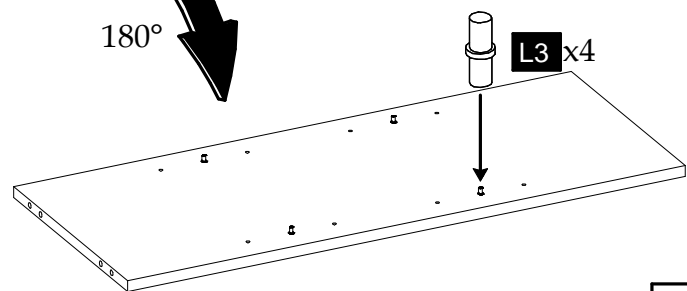
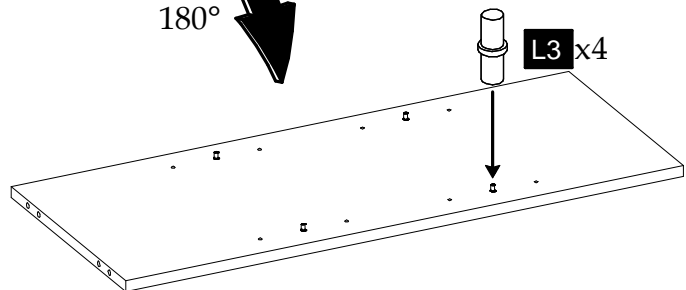
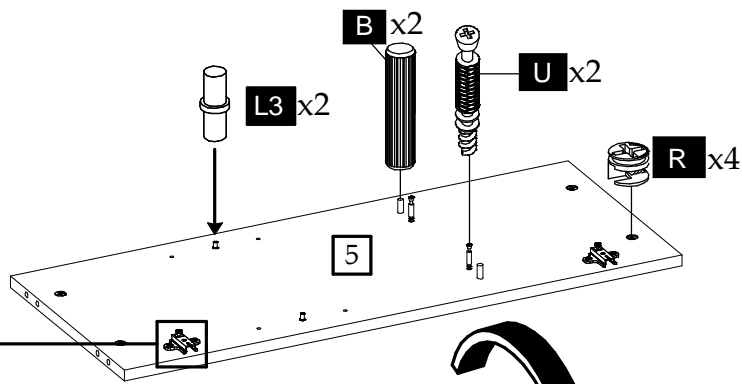
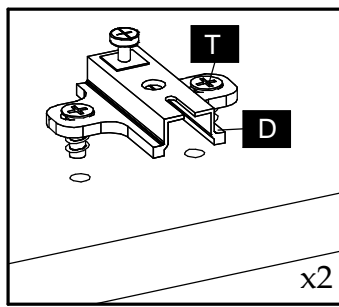

3

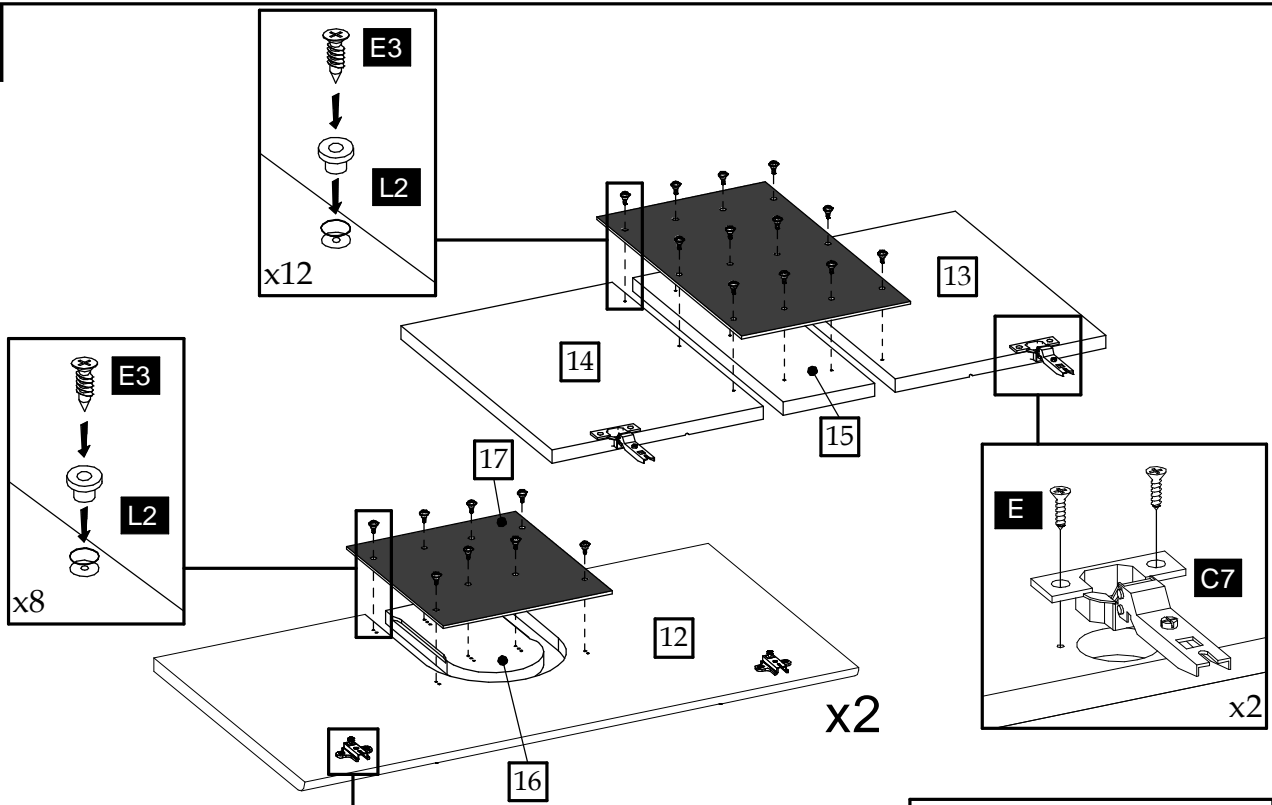

4

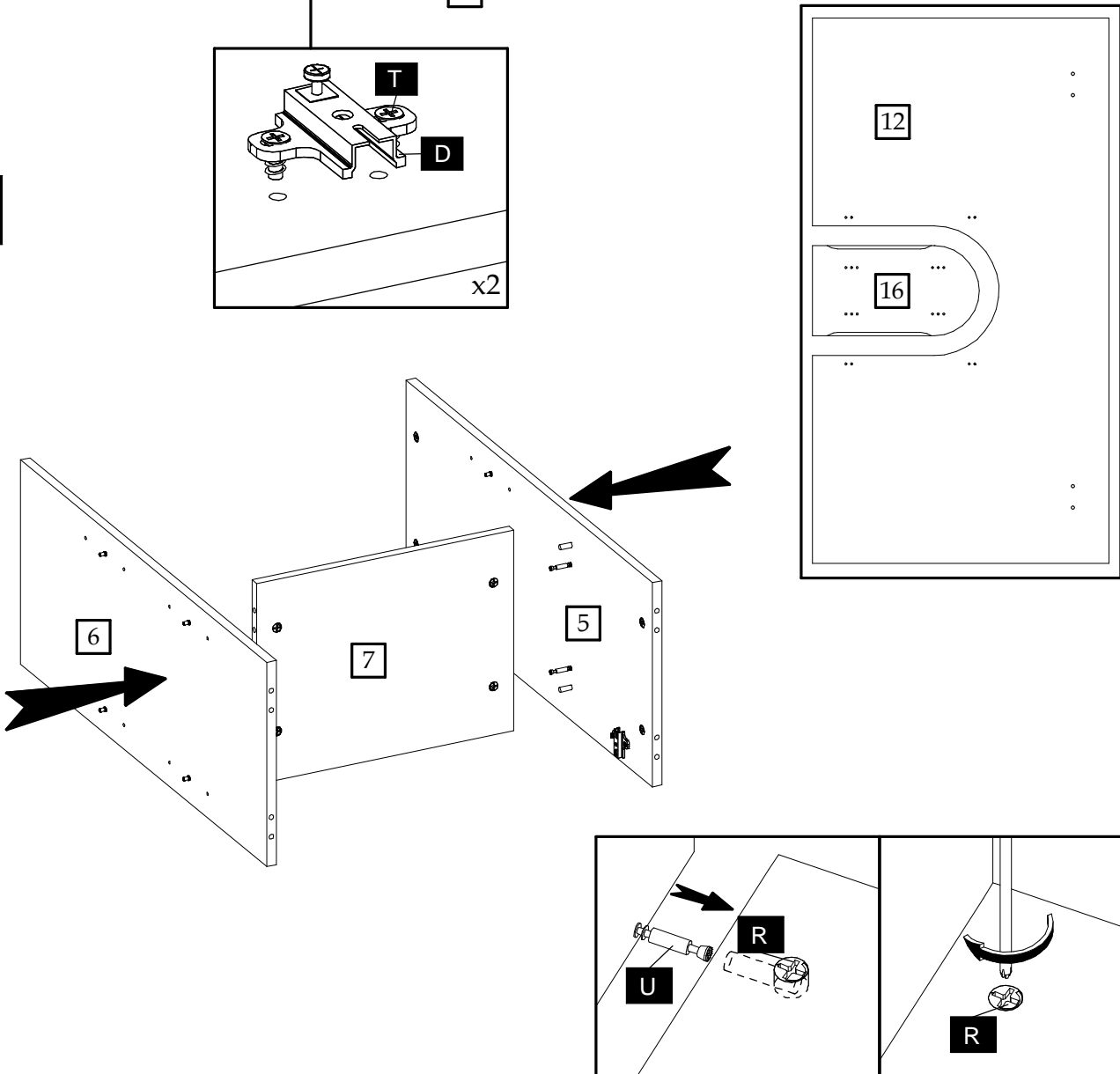

5

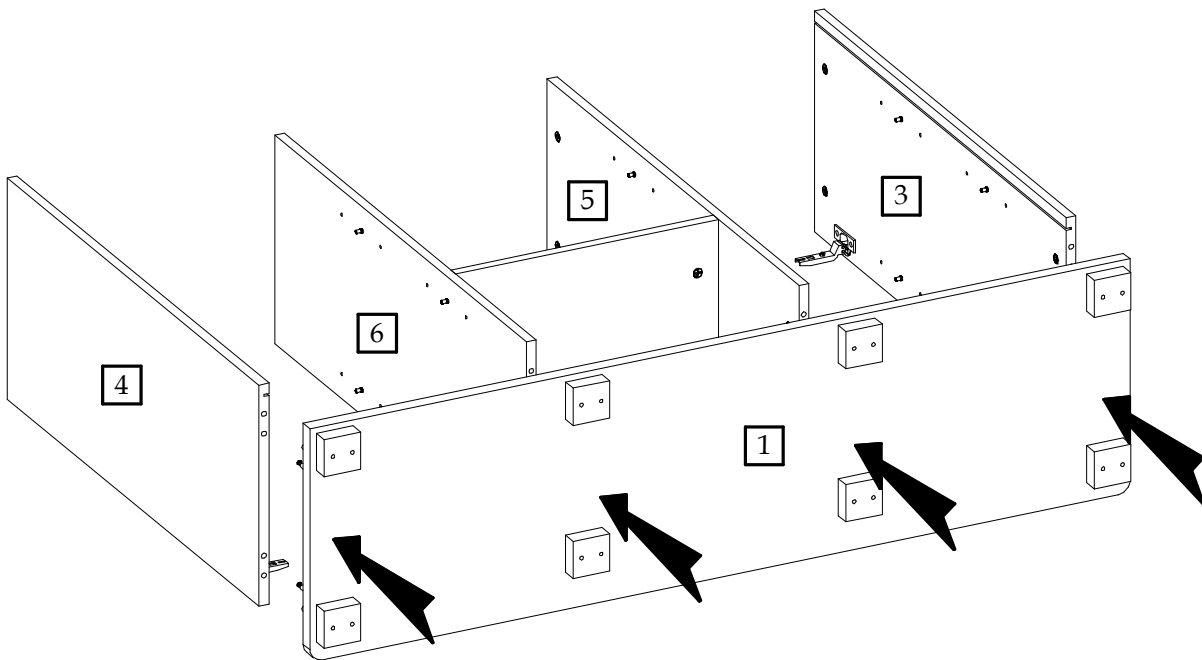

6

