

# RODAN

## Typ A2

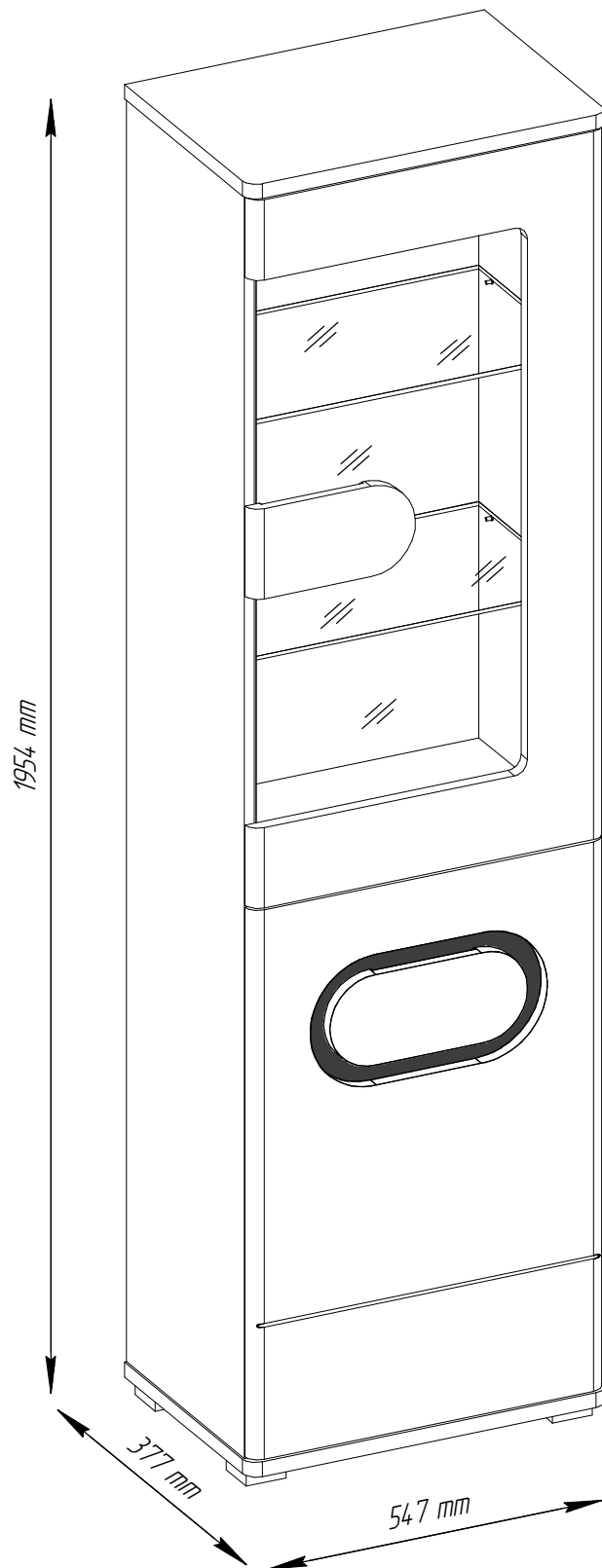

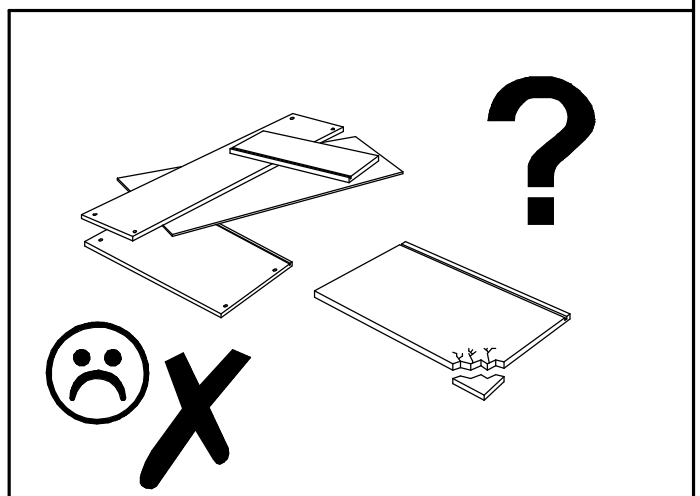

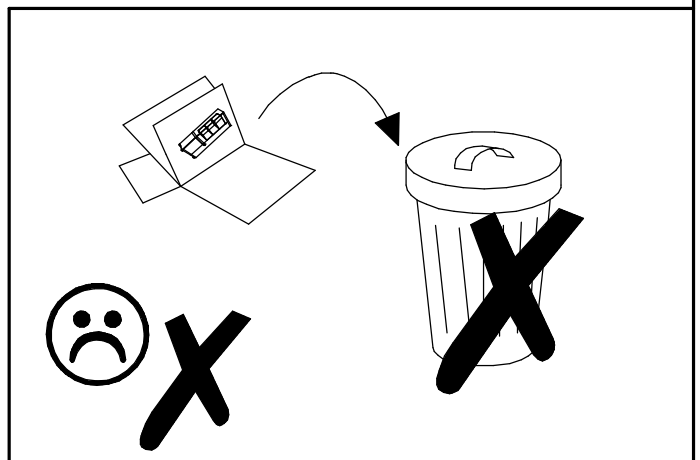
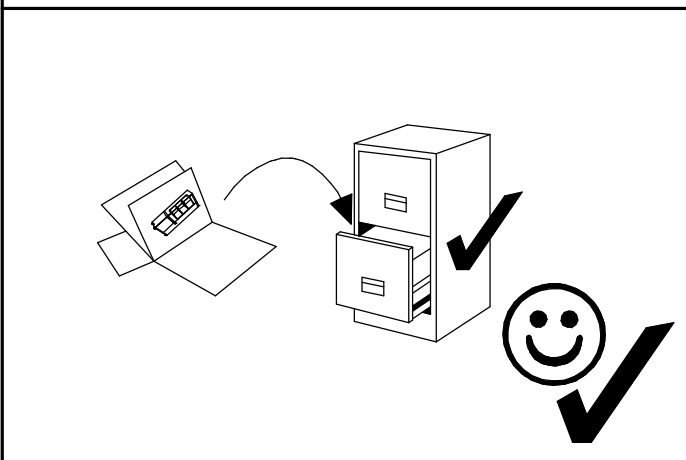
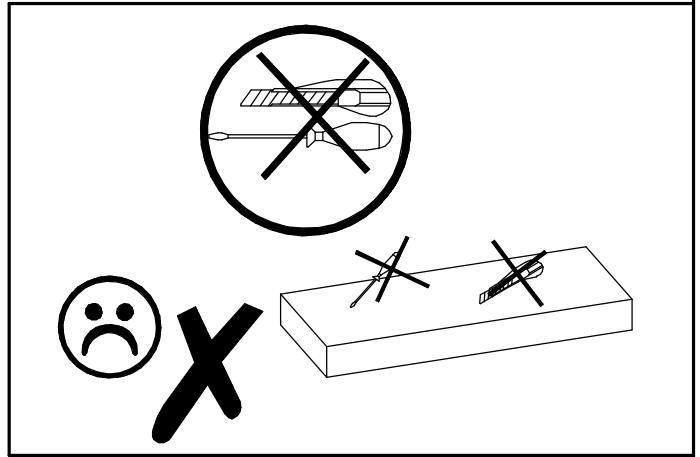
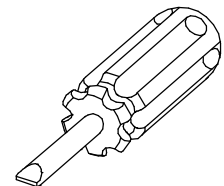
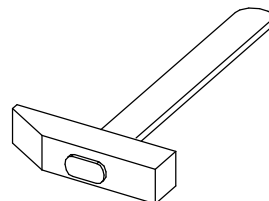
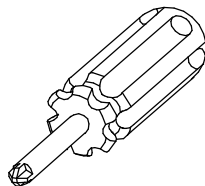
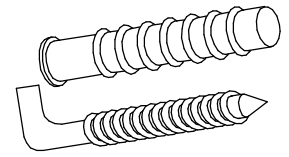
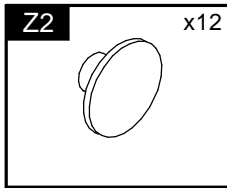
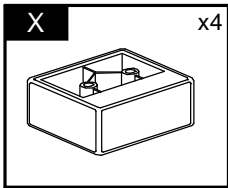
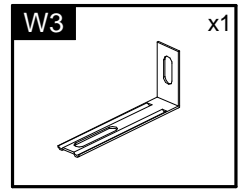
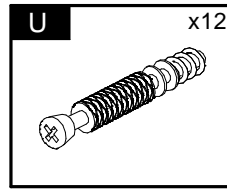
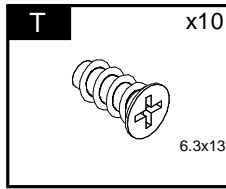
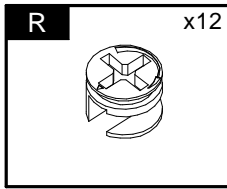
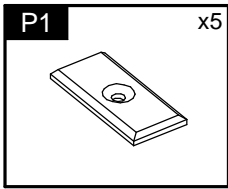
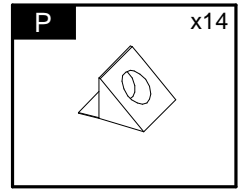
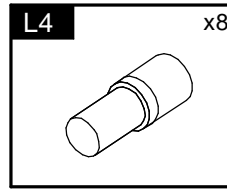
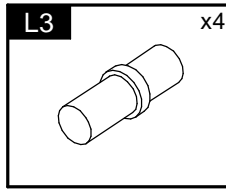
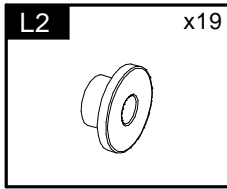
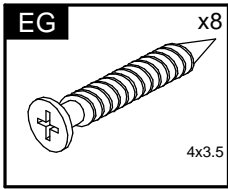
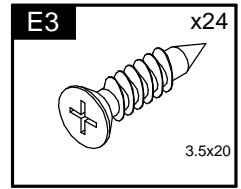
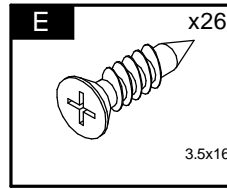
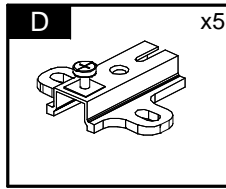
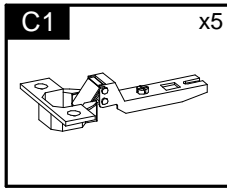
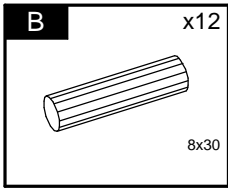

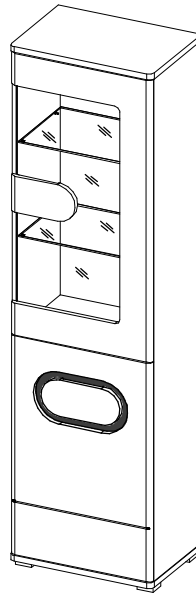

Element symbol	Measurements				Code	Paket
1	547	377	22	1	1002	1/3
2	547	377	22	1	1003	1/3
3	1885	357	16	1	1004	1/3
4	1885	357	16	1	1005	1/3
5	510	336.5	16	1	1022	1/3
6	510	325	16	1	N/A	1/3
7	1068	524	3	1	N/A	2/3
8	830	524	3	1	N/A	2/3
9	820	539	19	1	3039	2/3
10	1057	539	19	1	3019	2/3
11	250	135	19	1	3016	2/3
12	300	135	19	1	3017	2/3
13	370	250	4	1	N/A	3/3
14	880	433	4	1	N/A	3/3
15	509	320	6	2	N/A	3/3

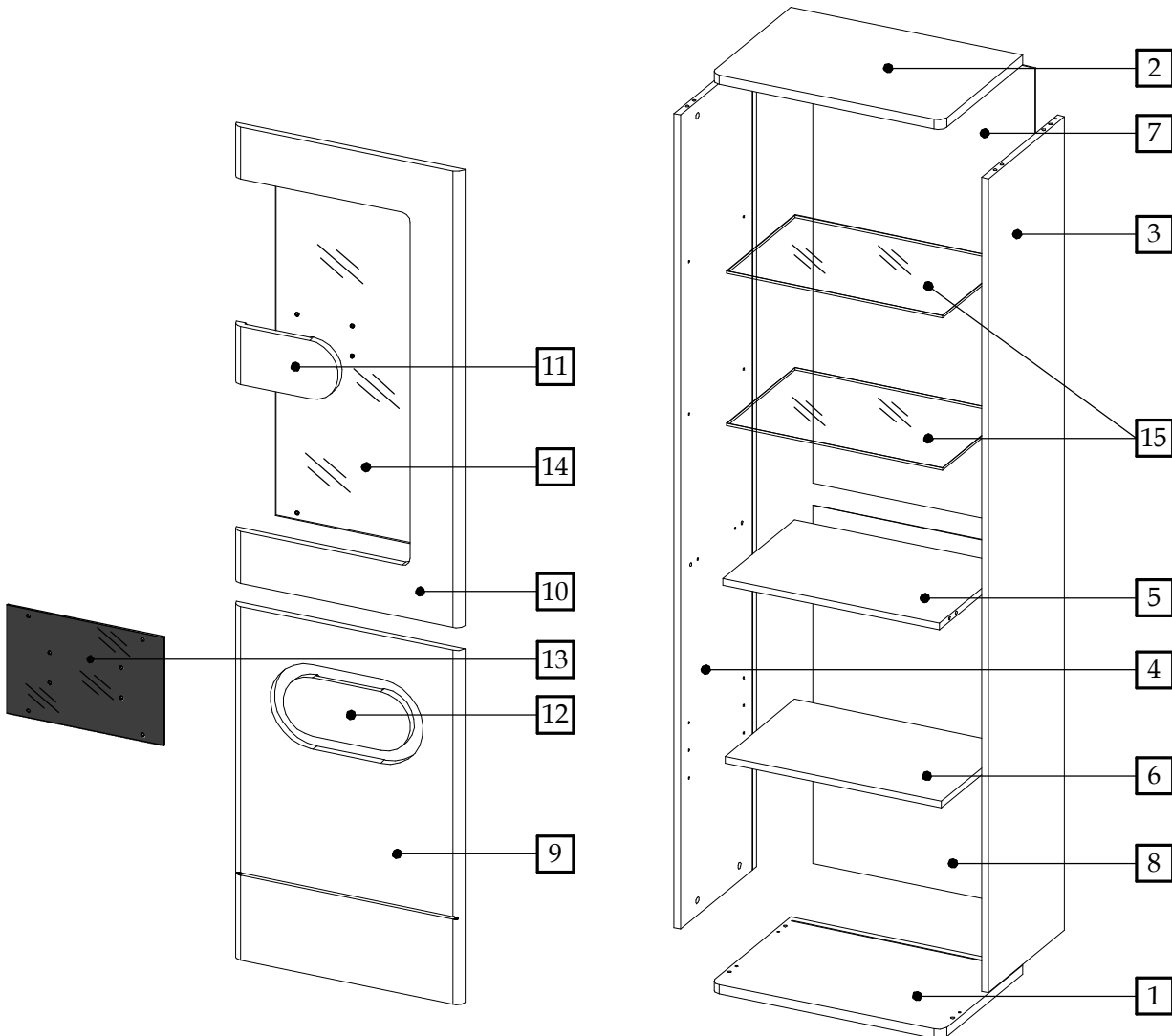

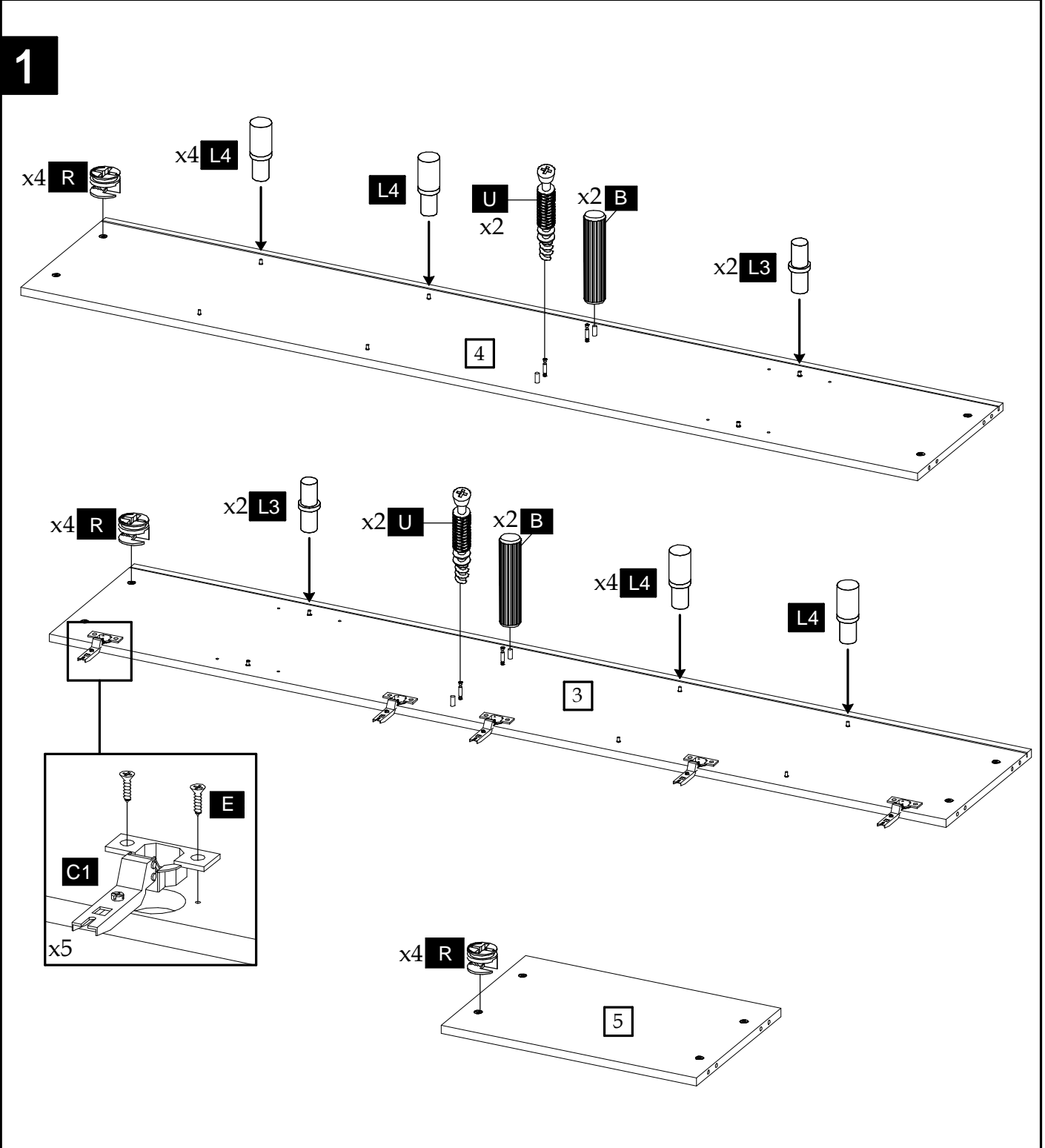

2

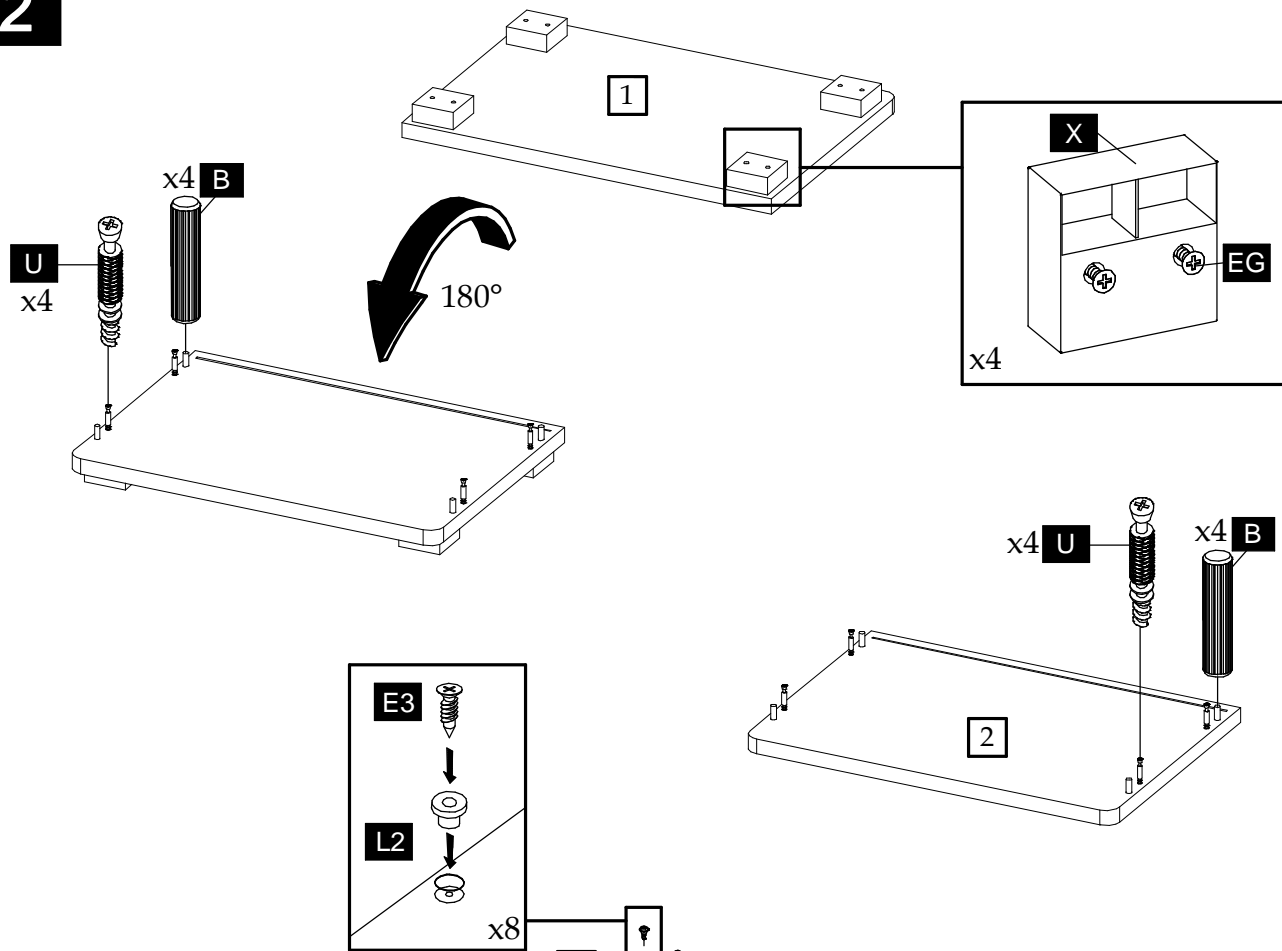

3

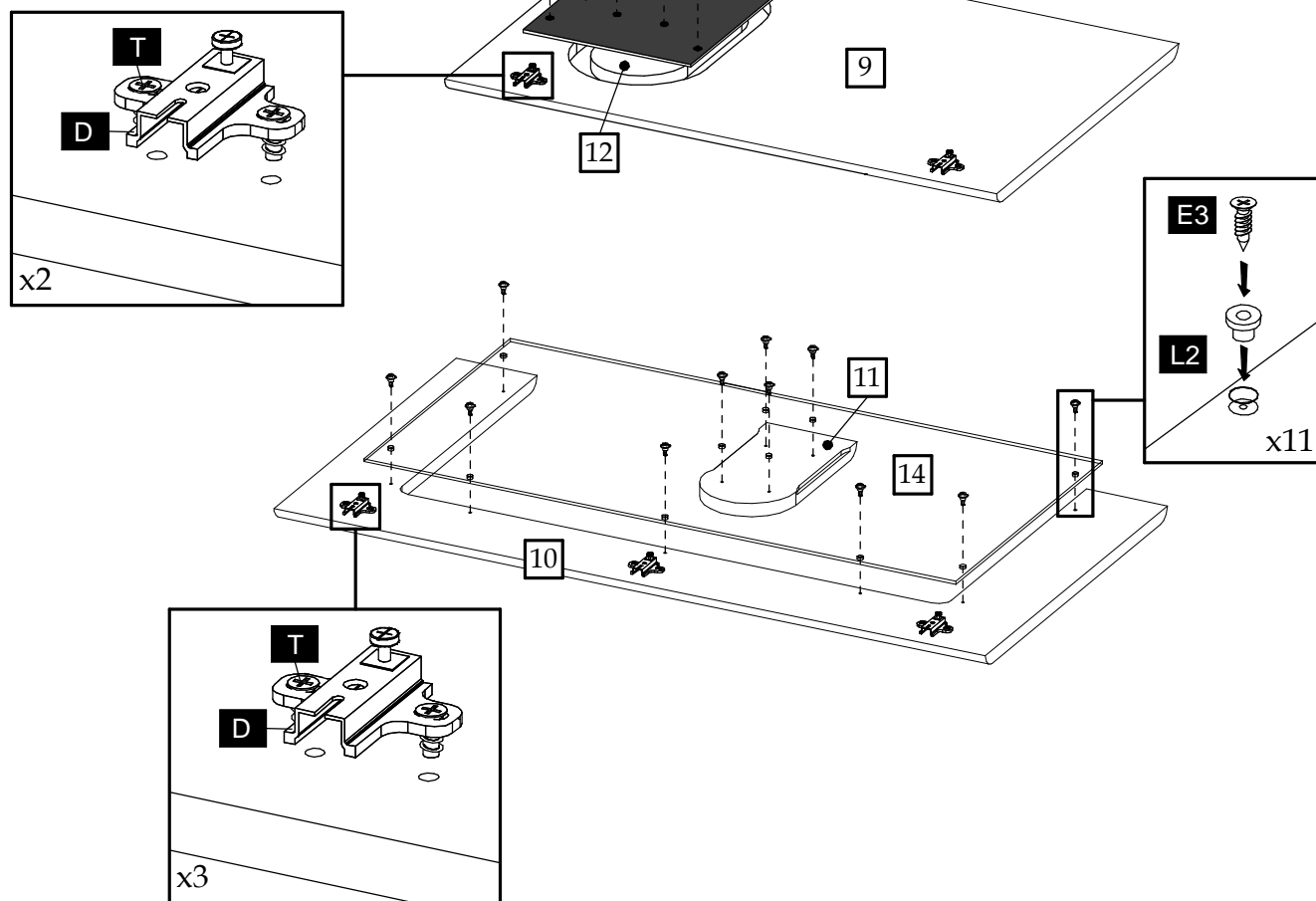

4

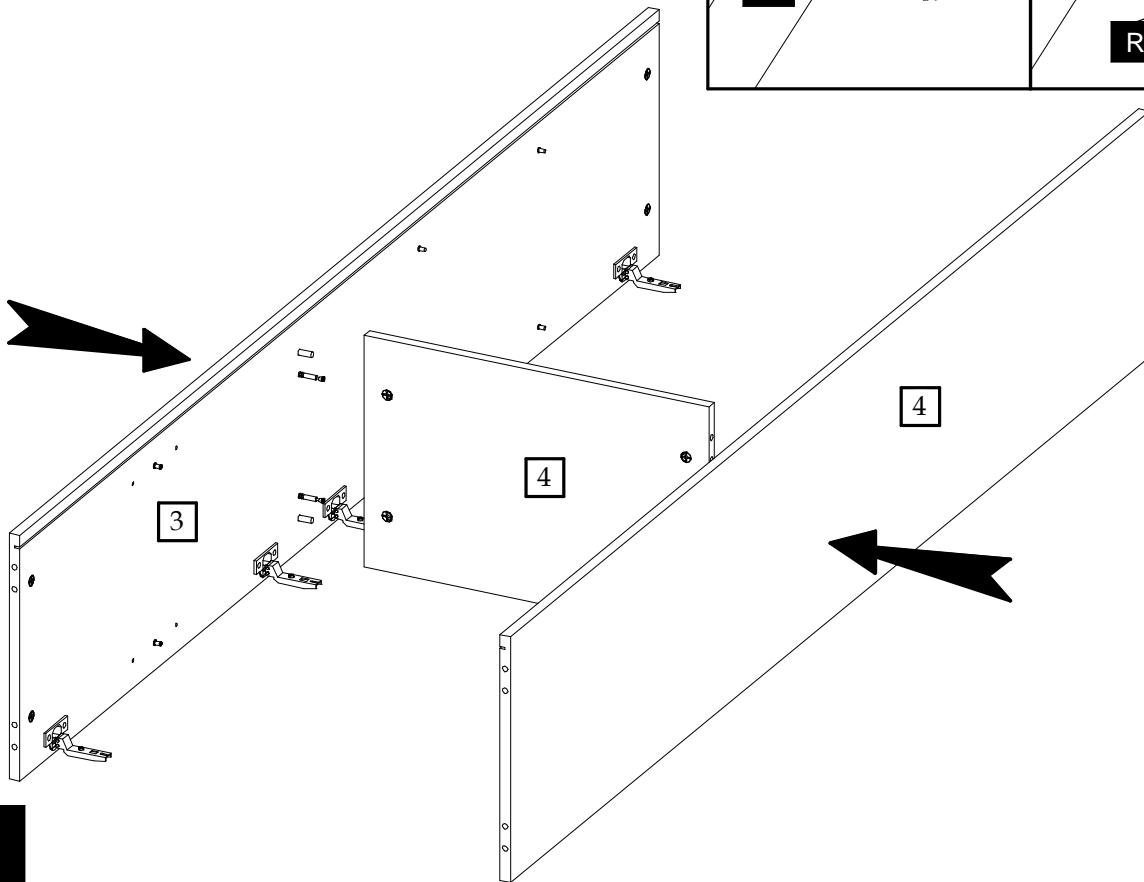

5

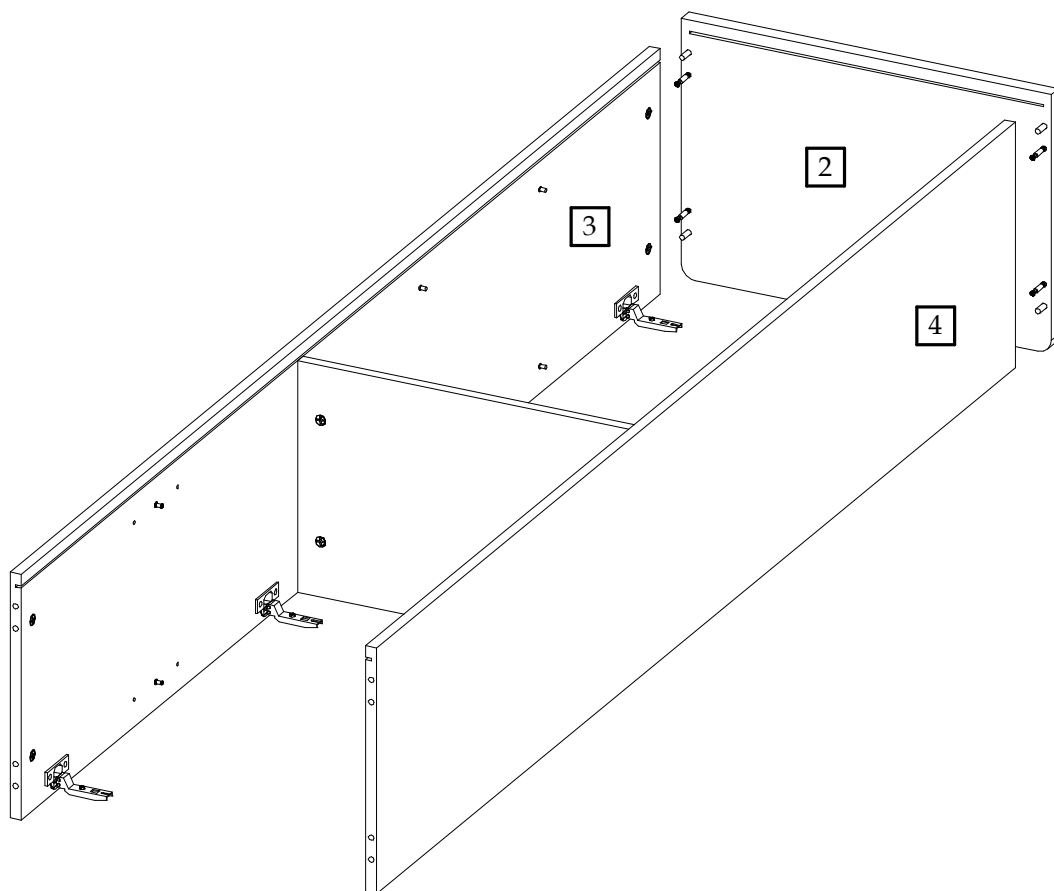

6

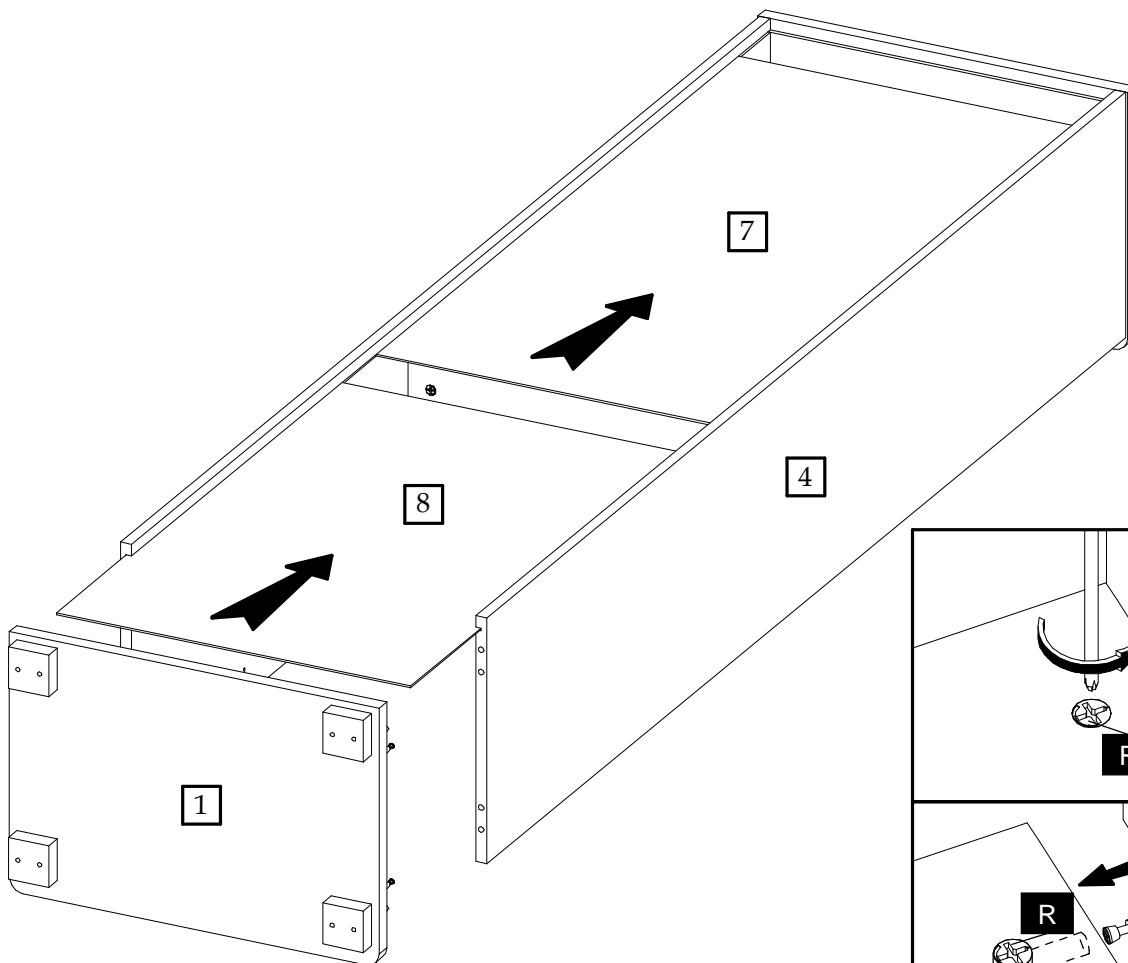

7

