

RODAN

Typ V2

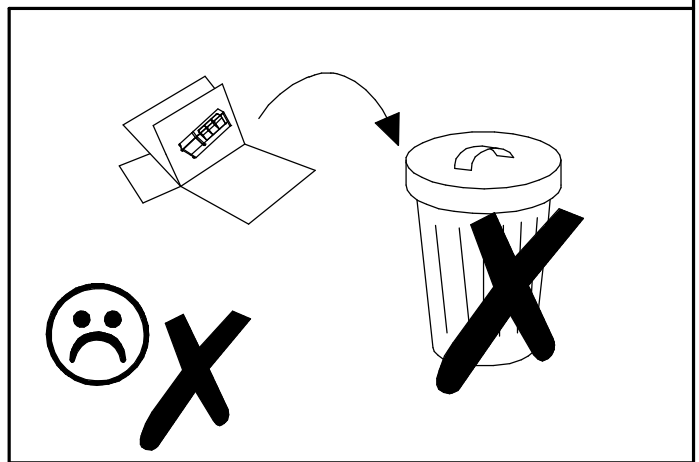

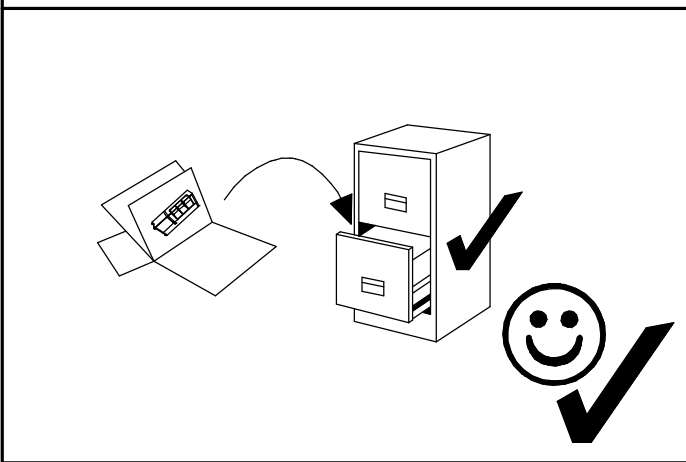

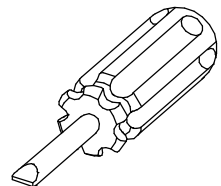
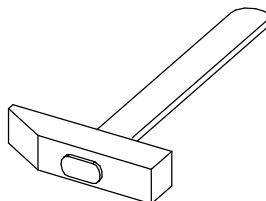
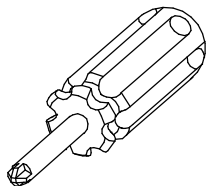
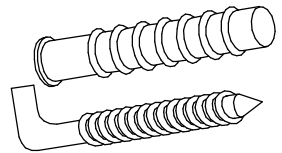
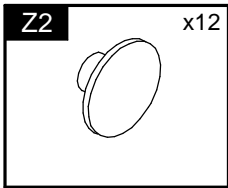
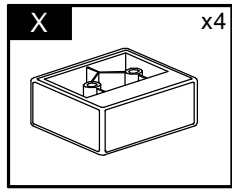
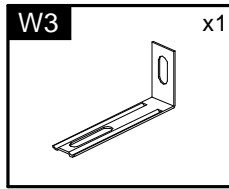
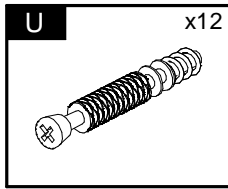
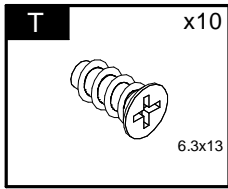
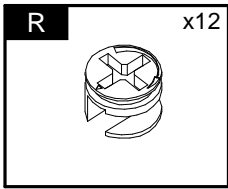
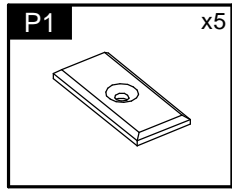
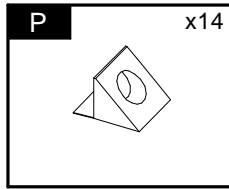
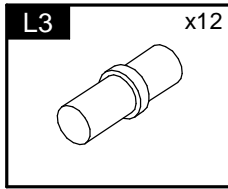
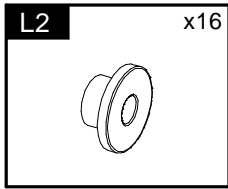
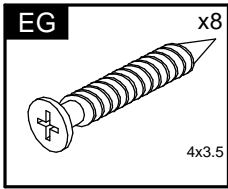
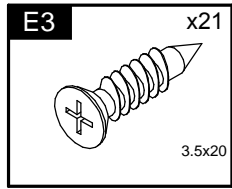
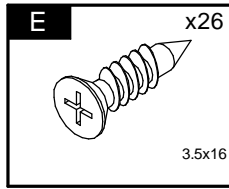
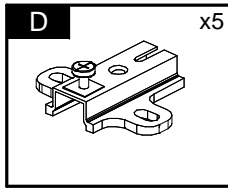
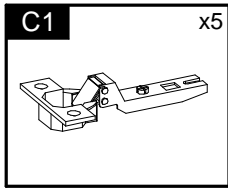
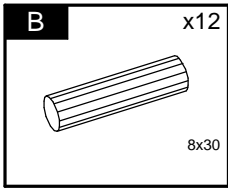

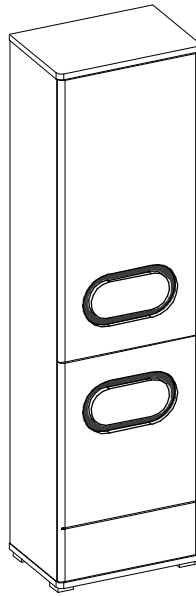

Element symbol	Measurements				Code	Paket
1	547	377	22	1	1002	1/3
2	547	377	22	1	1003	1/3
3	1885	357	16	1	1004	1/3
4	1885	357	16	1	1005	1/3
5	510	336.5	16	1	1022	1/3
6	510	325	16	3	N/A	1/3
7	1068	524	3	1	N/A	2/3
8	830	524	3	1	N/A	2/3
9	820	539	19	1	3010	2/3
10	1057	539	19	1	3020	2/3
11	300	135	19	2	3017	2/3
12	370	250	4	2	N/A	3/3

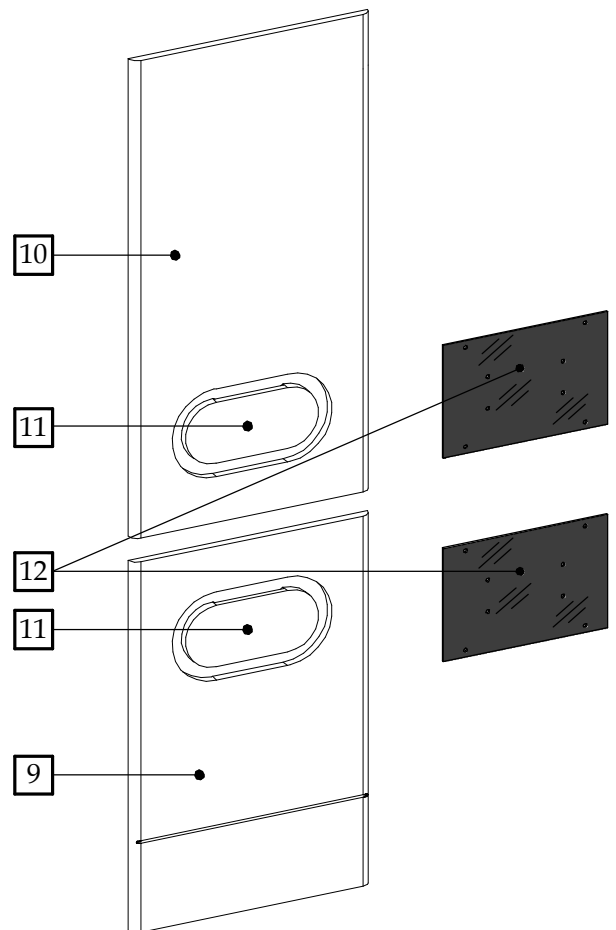
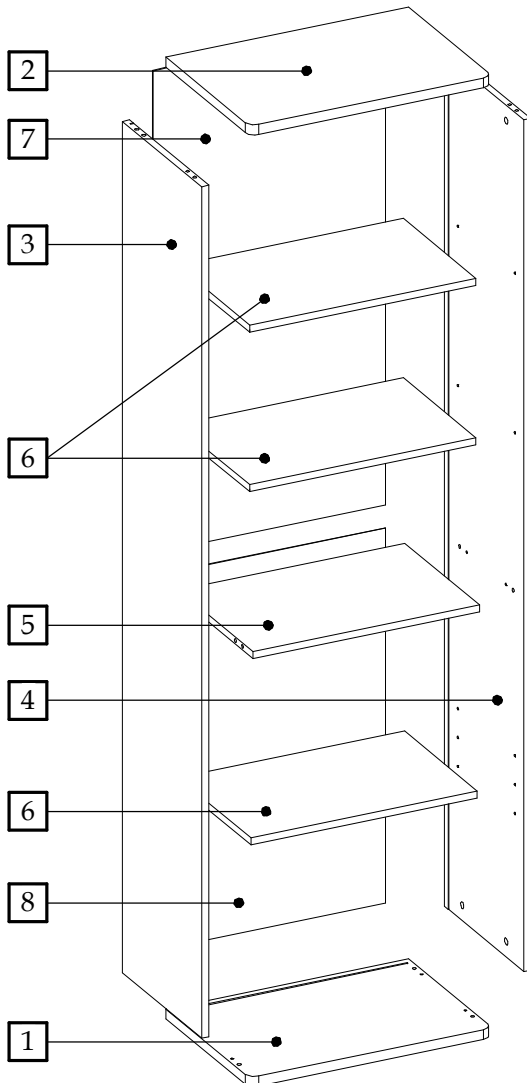

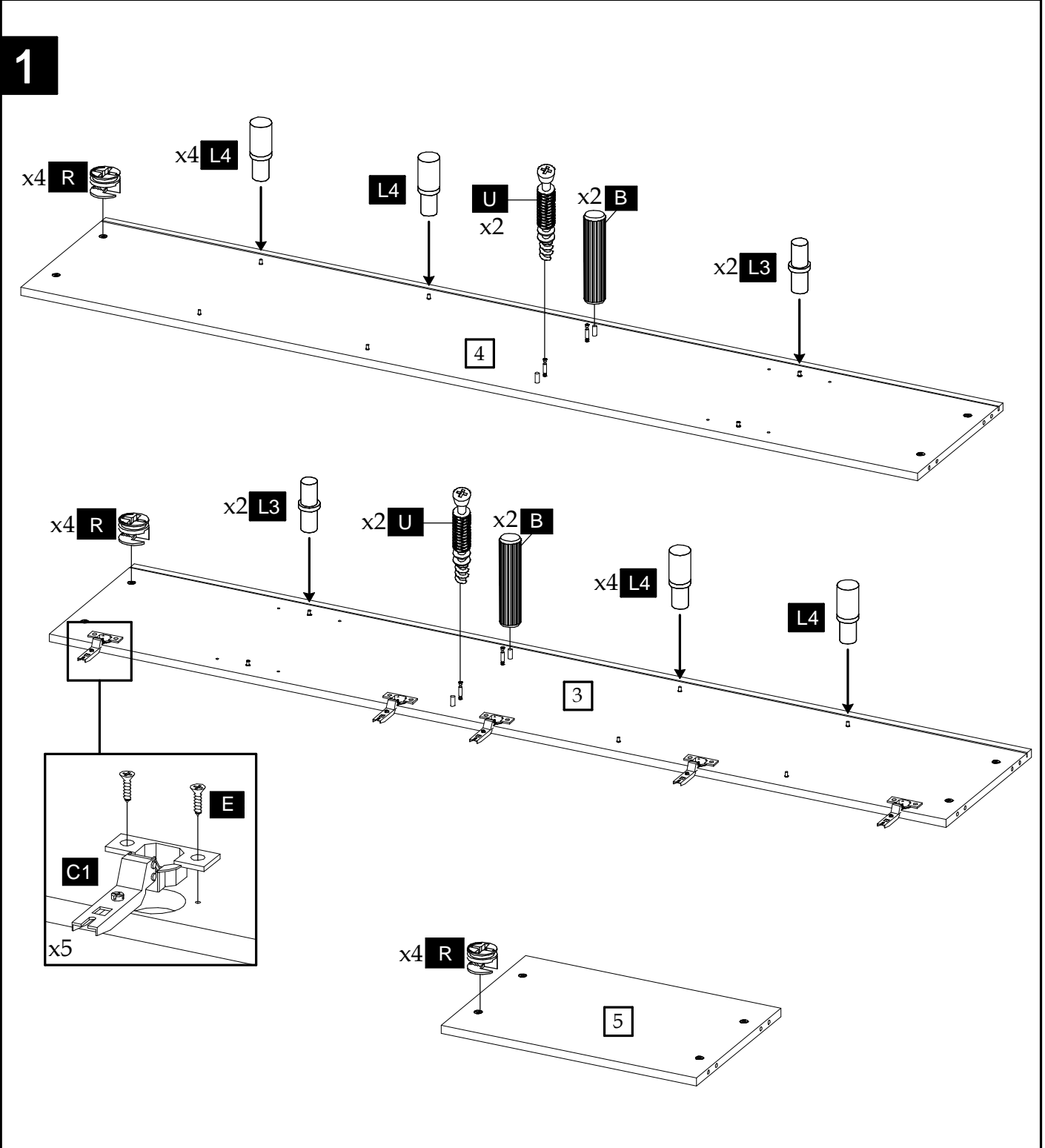

2

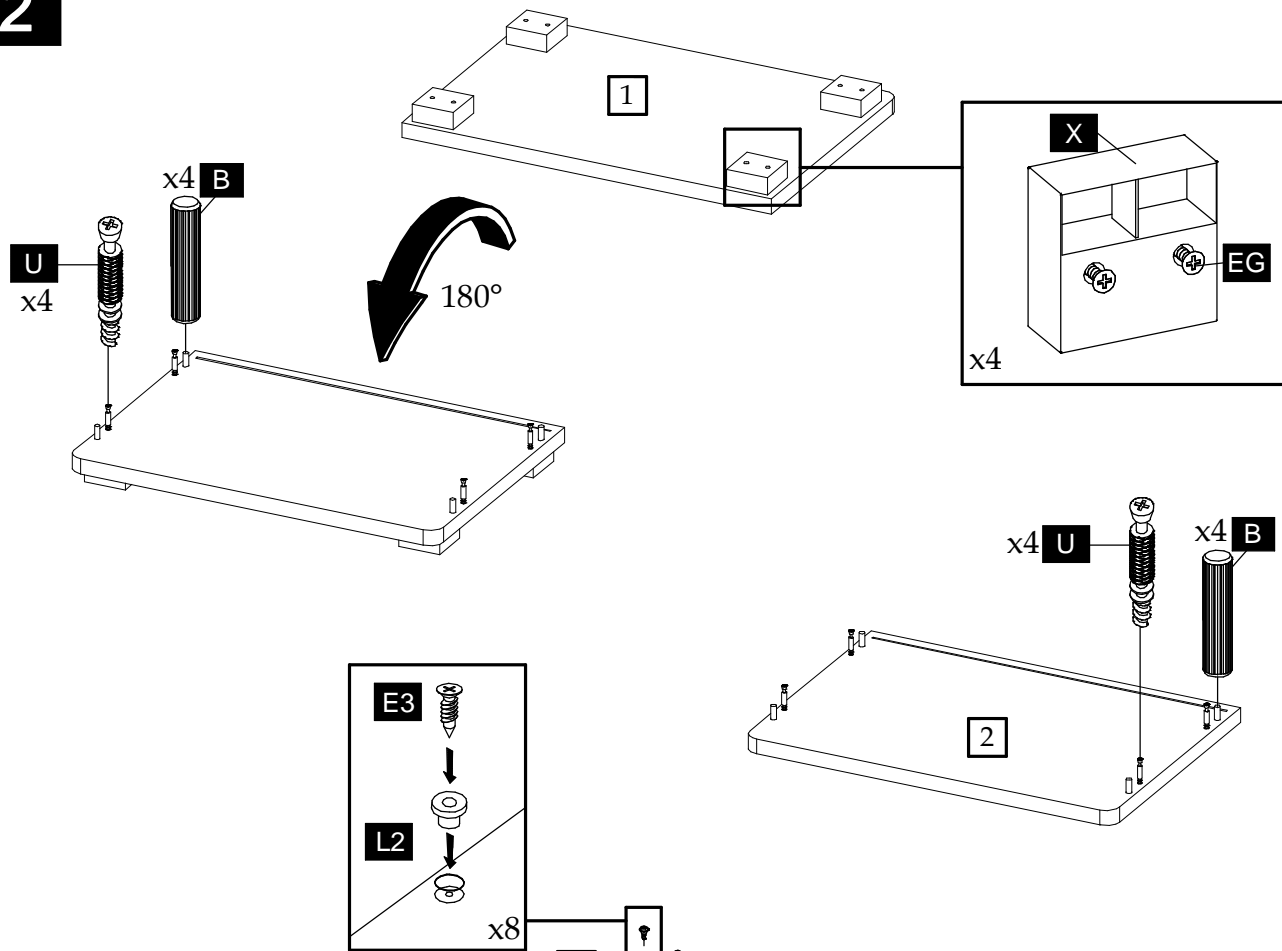

3

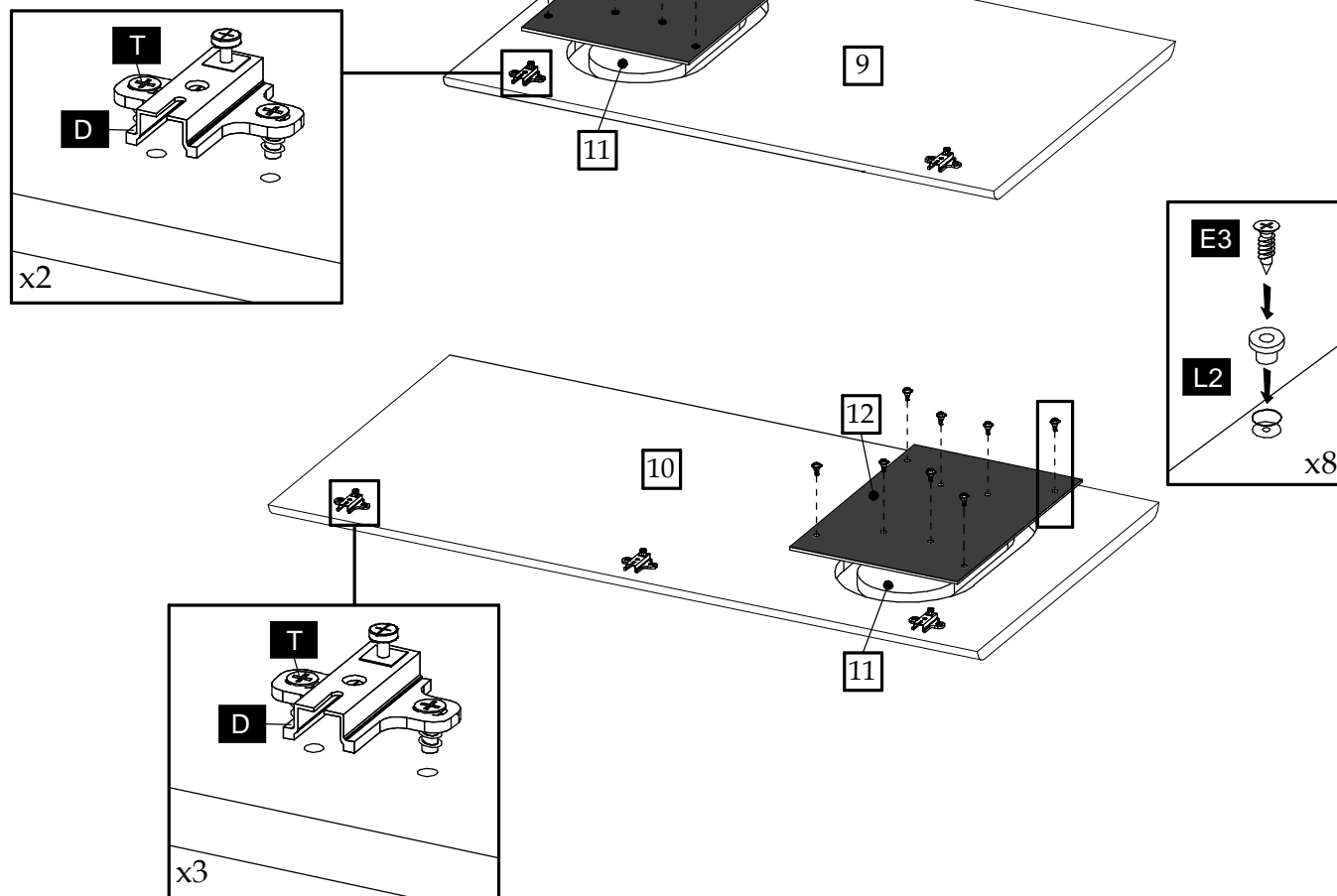

4

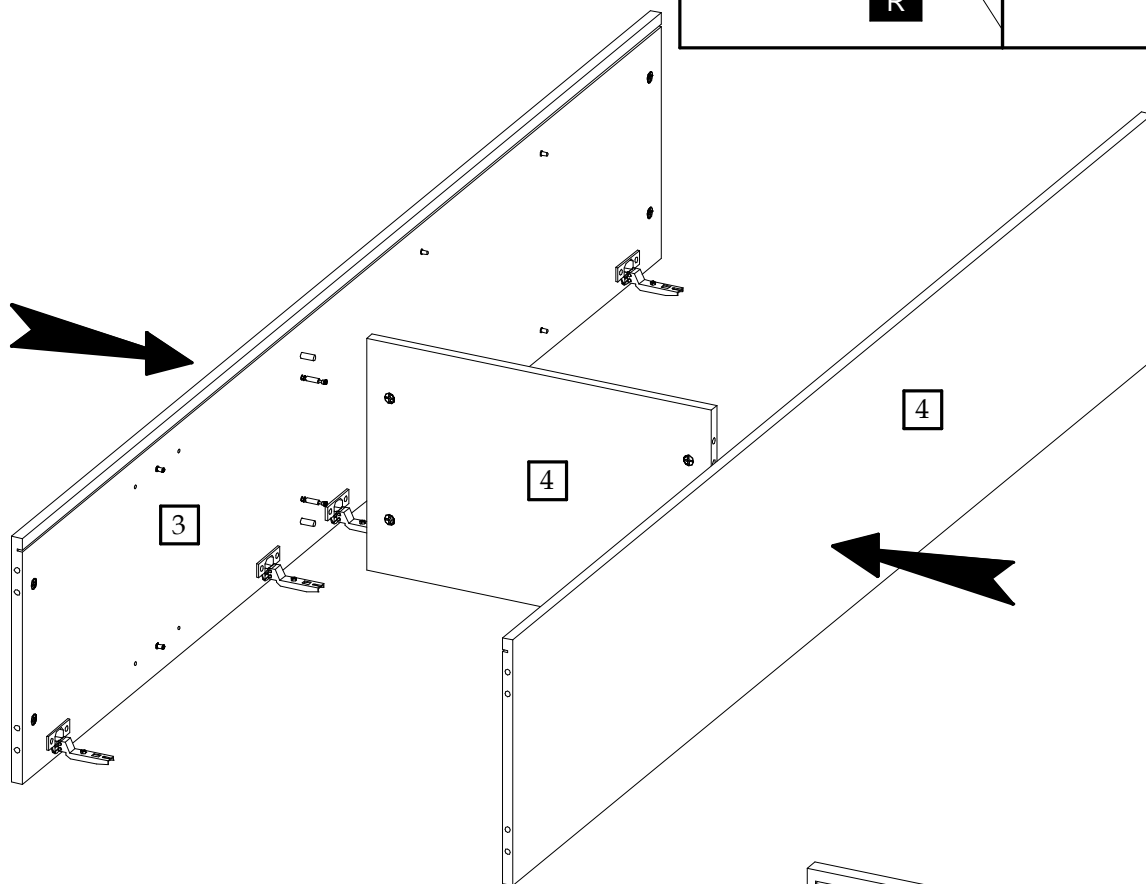
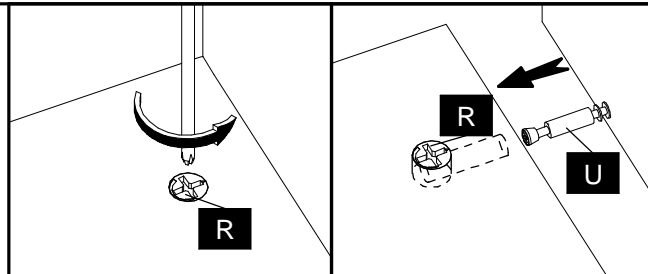

5

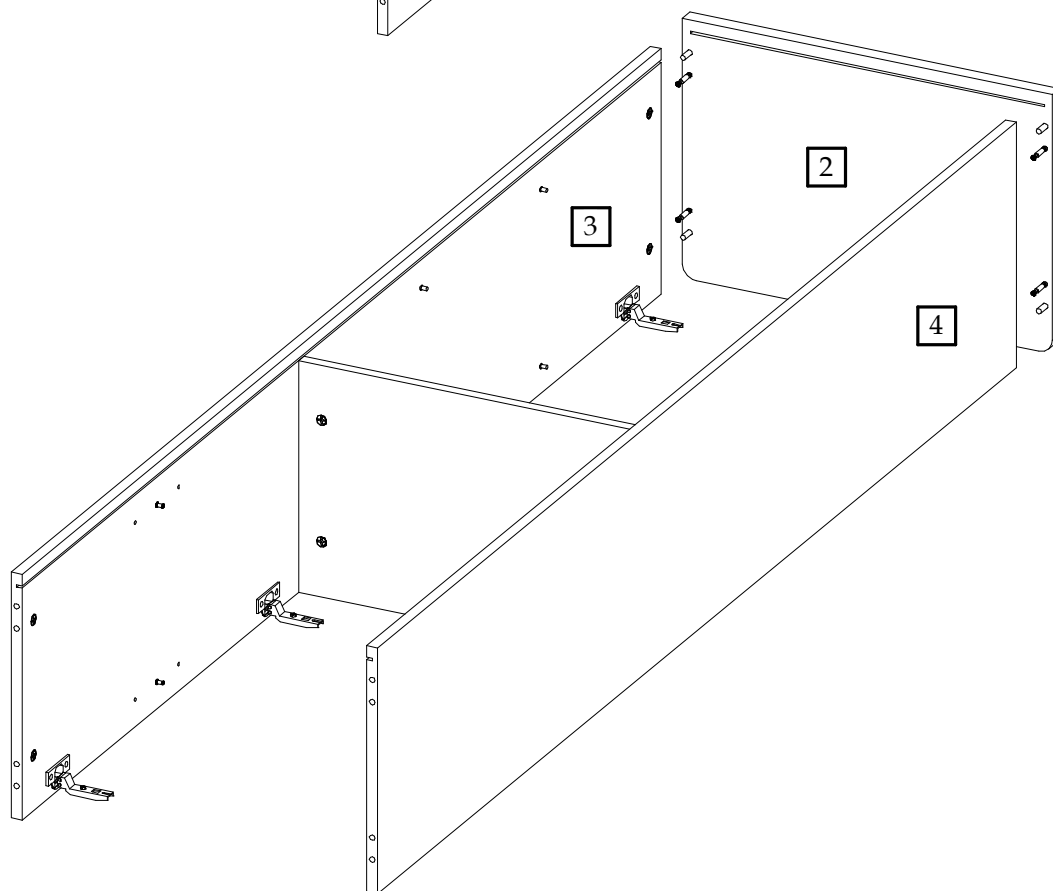

6

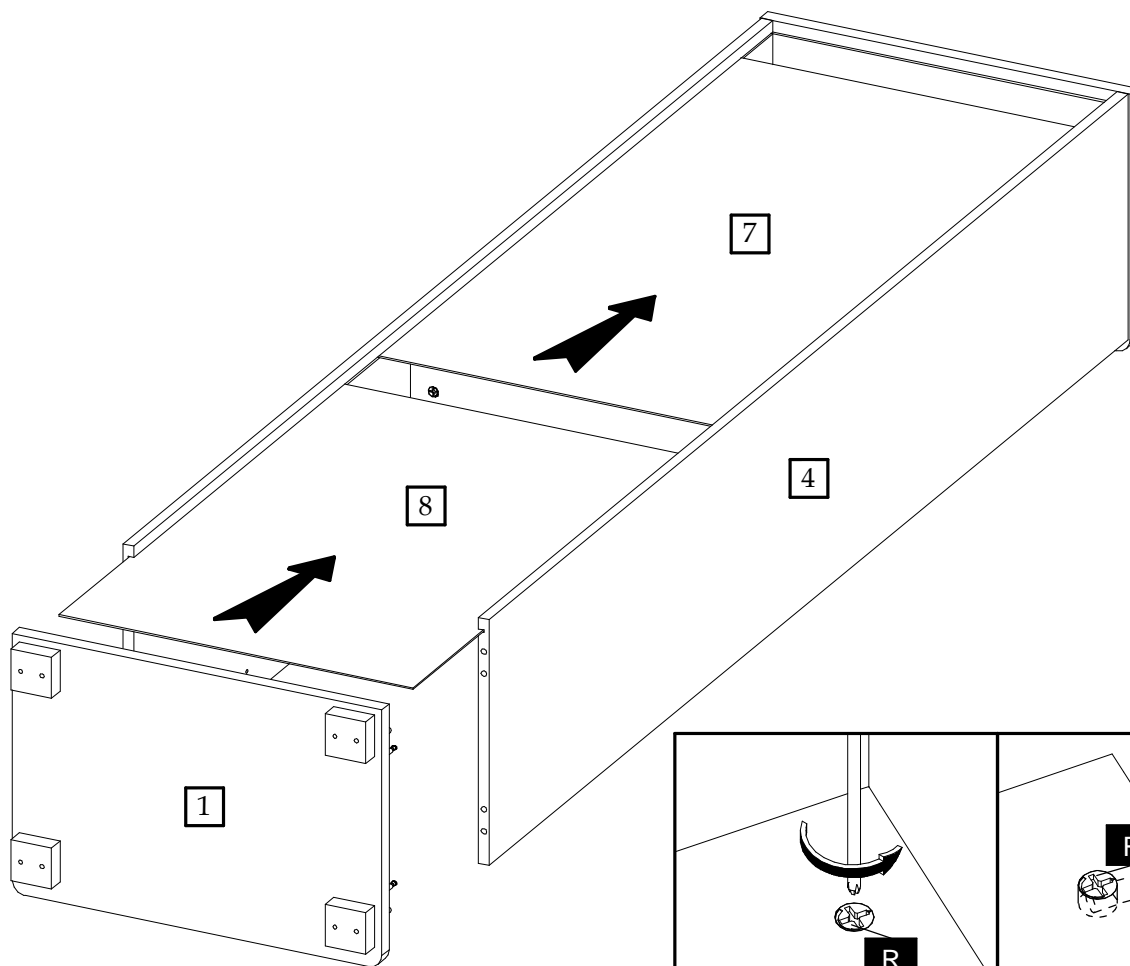

7

