

FIDEL

Typ Q

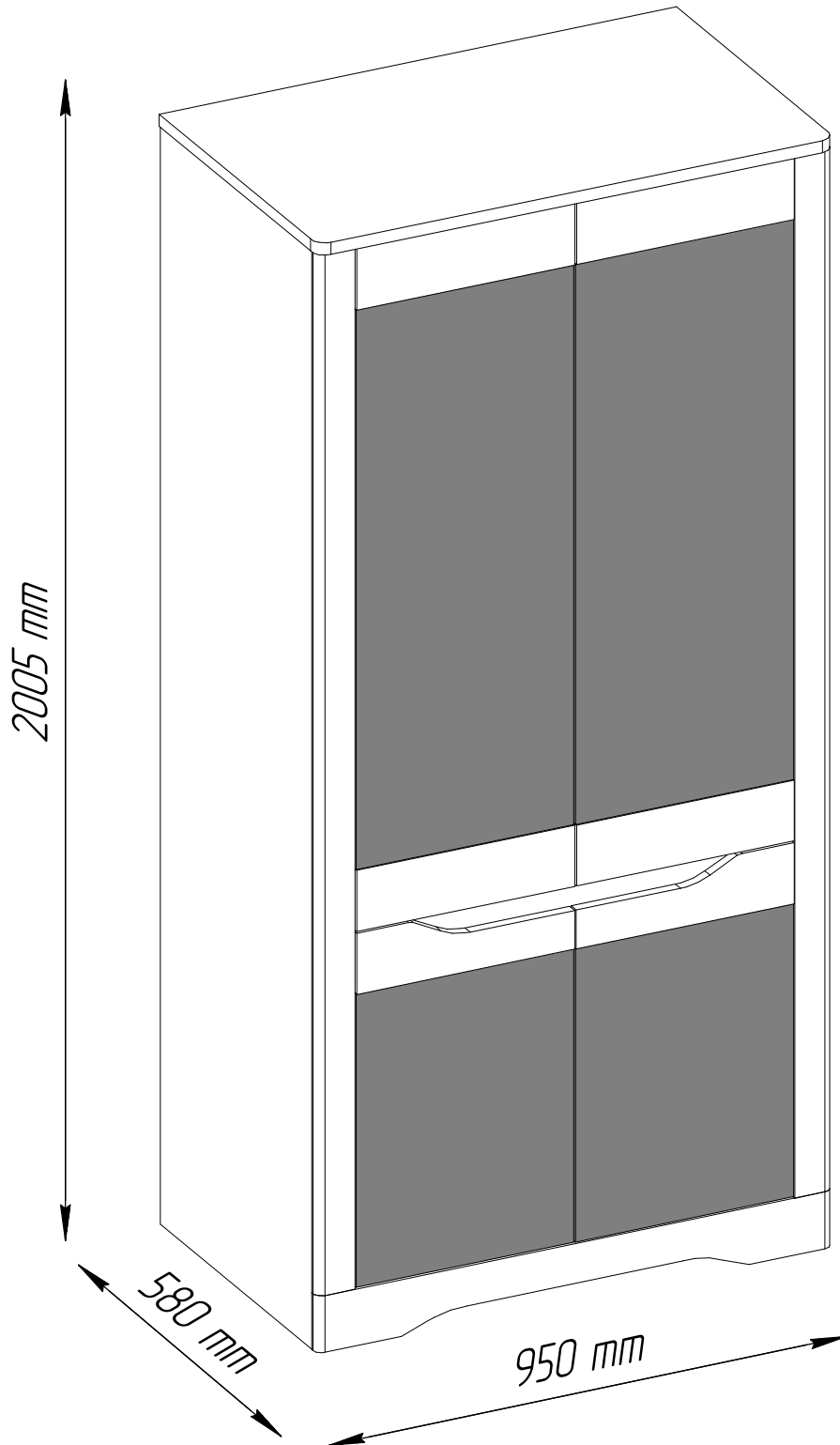

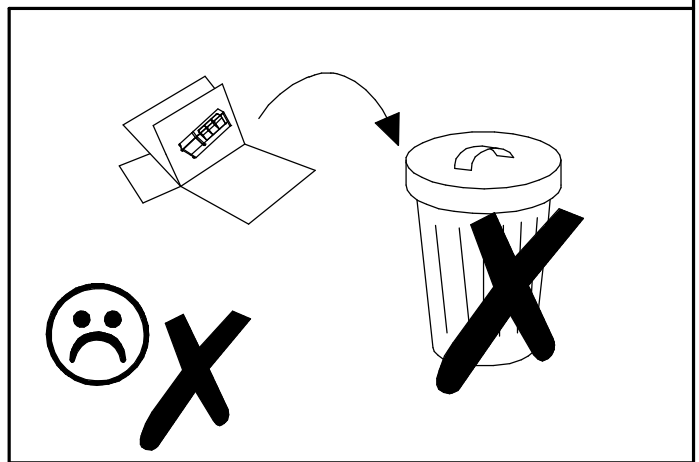

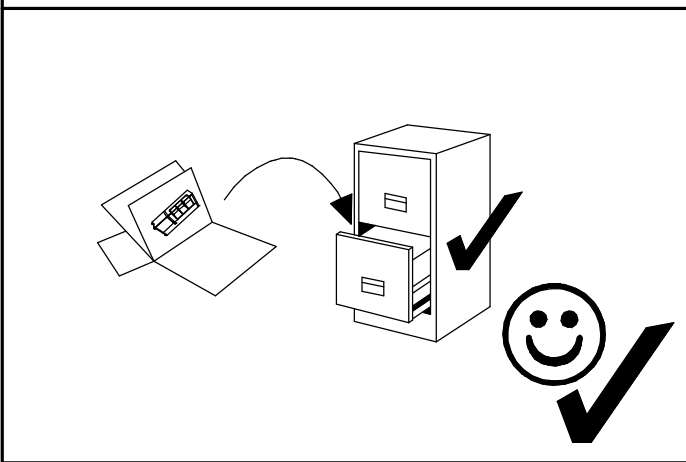
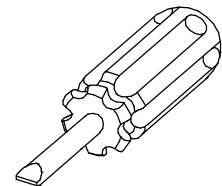
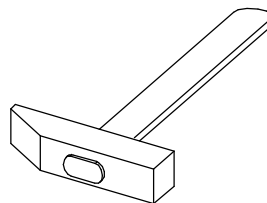
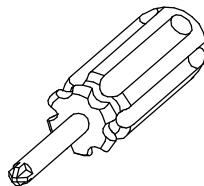
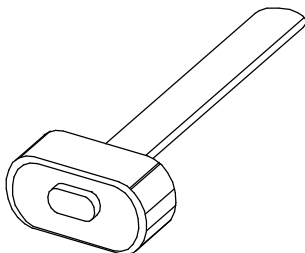
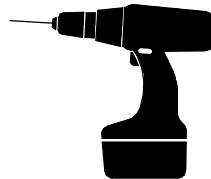
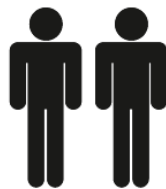
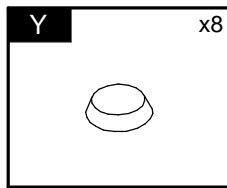
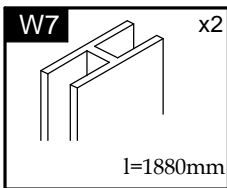
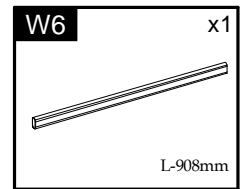
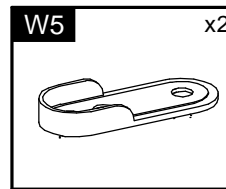
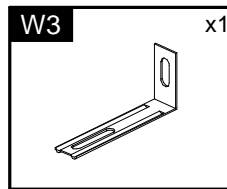
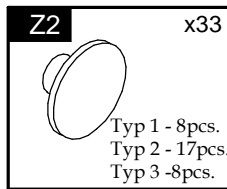
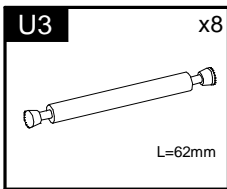
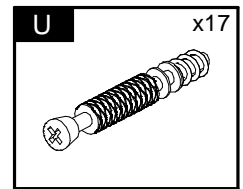
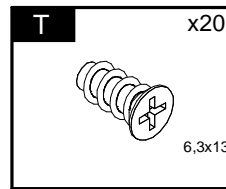
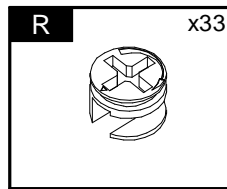
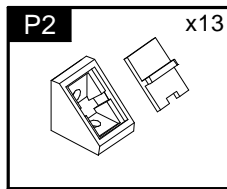
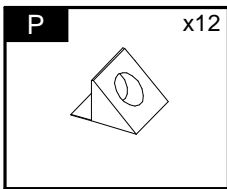
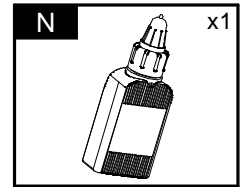
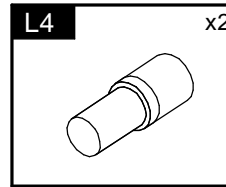
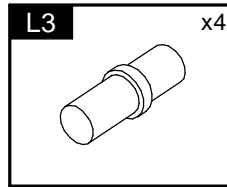
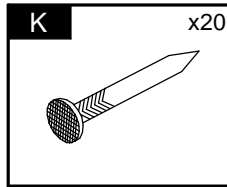
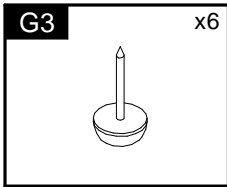
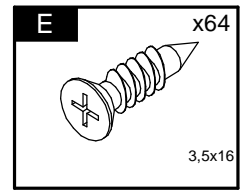
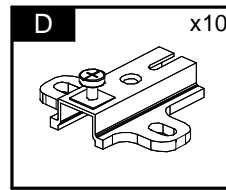
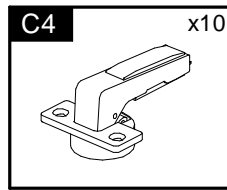
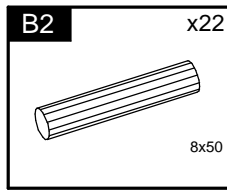
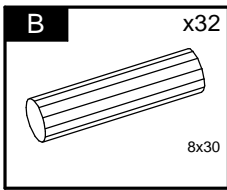
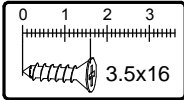
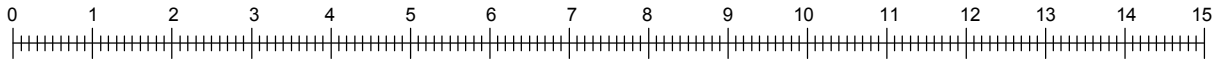

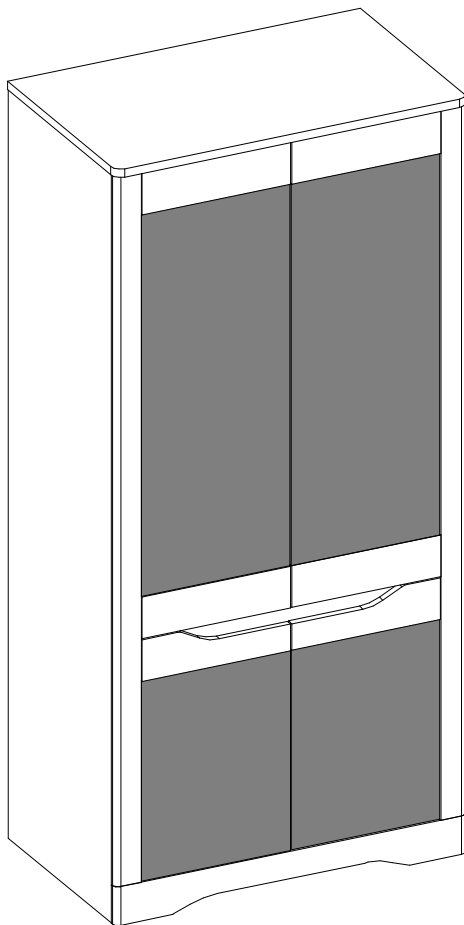

Element symbol	Measurements				Code	Paket
1	949	582	22	1	1002/2002	2/2
2	400	84	22	1	1008	2/2
3	1978	556	16	1	1003	1/2
4	1978	556	16	1	1004	1/2
5	913	542	16	1	1005	2/2
6	913	542	16	1	N/A	2/2
7	913	70	16	1	1025	2/2
8	913	524	16	1	1026	2/2
9	1009	400	16	1	1017	1/2
10	529	400	16	1	1018	1/2
11	1009	400	16	1	1019	1/2
12	529	400	16	1	1020	1/2
13	1900	463	3	1	1031_v	1/2
14	1900	463	3	1	N/A	1/2
15	402	112	19	1	1001/3001	2/2
16	402	112	19	1	1006/3002	2/2
17	402	112	19	1	1001/3003	2/2
18	402	112	19	1	1007/3004	2/2
19	401	111	19	1	1002_v	2/2
20	401	111	19	1	1011_v	2/2
21	948	103	19	1	1012/3007	2/2
22	1878	72	19	1	1005/3008	1/2
23	1878	72	19	1	1005/3009	1/2

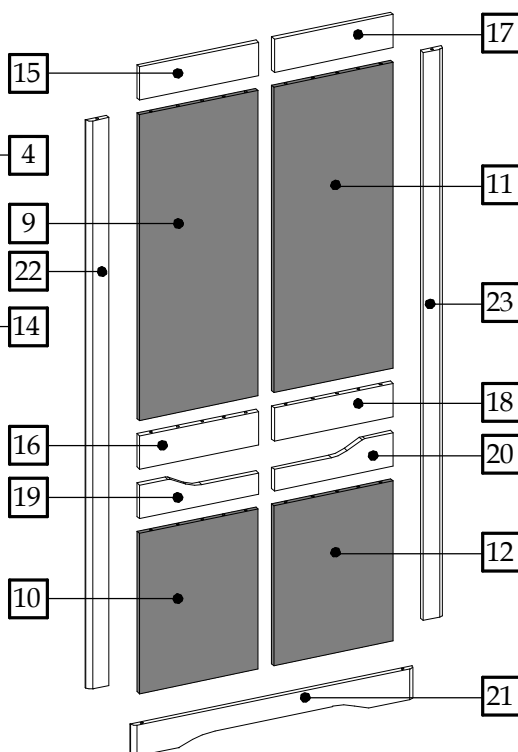
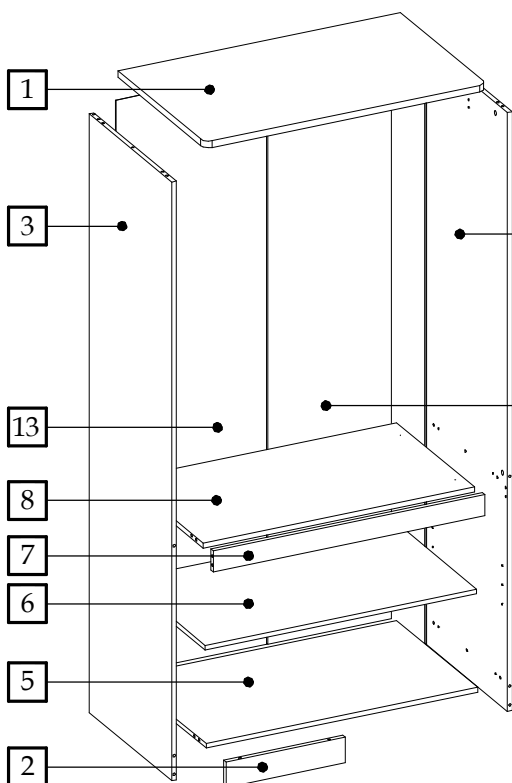

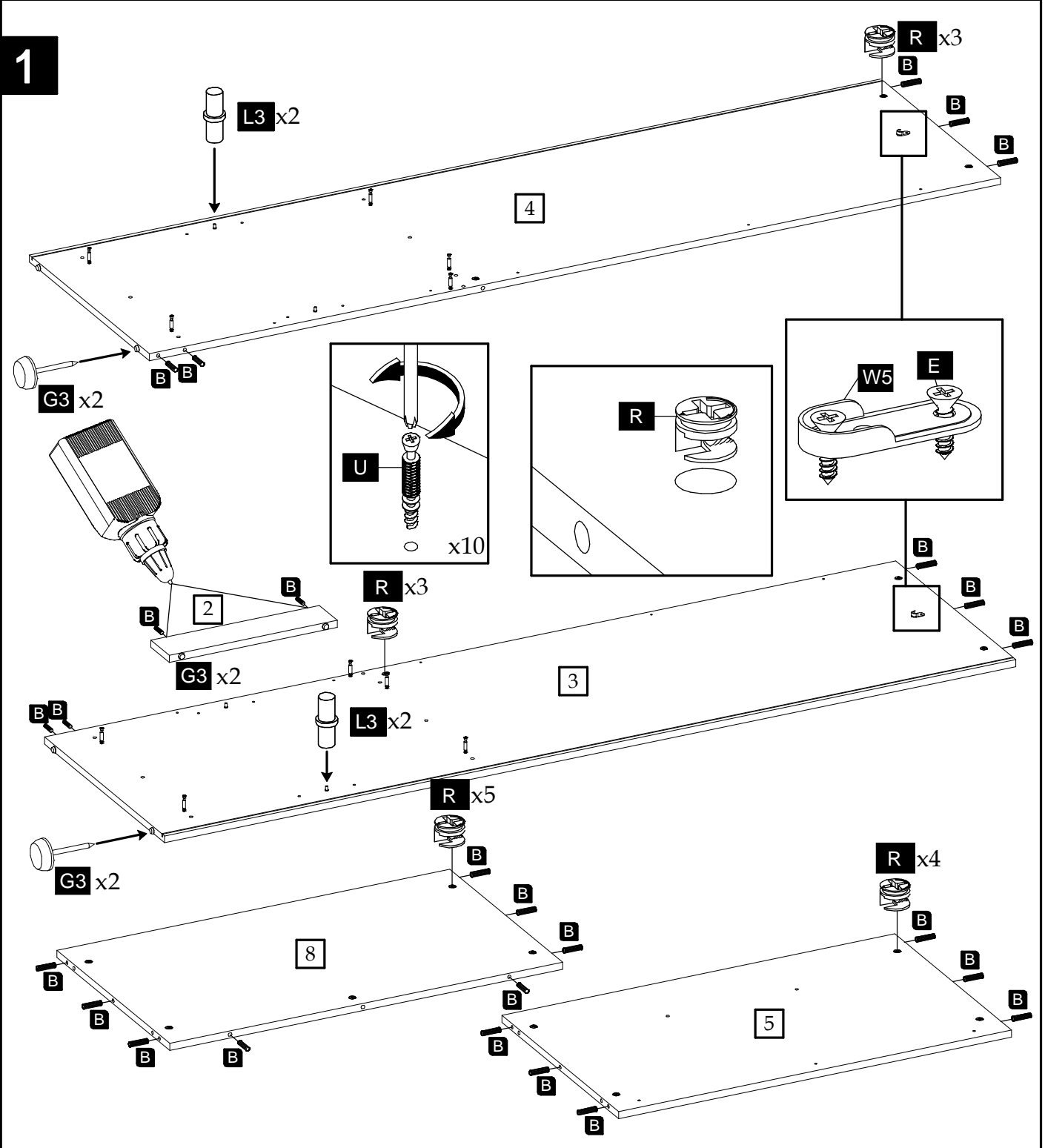

2

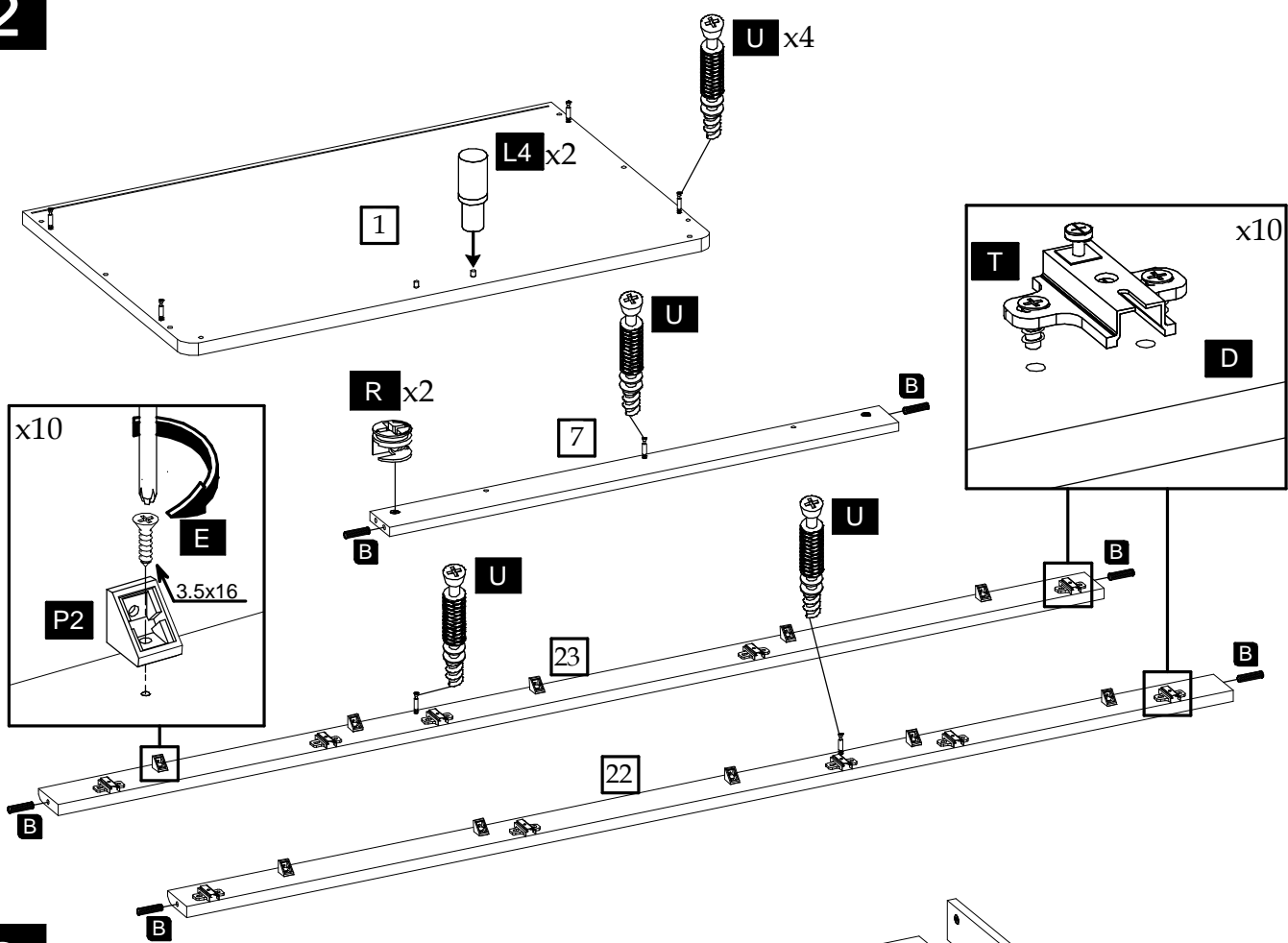

3

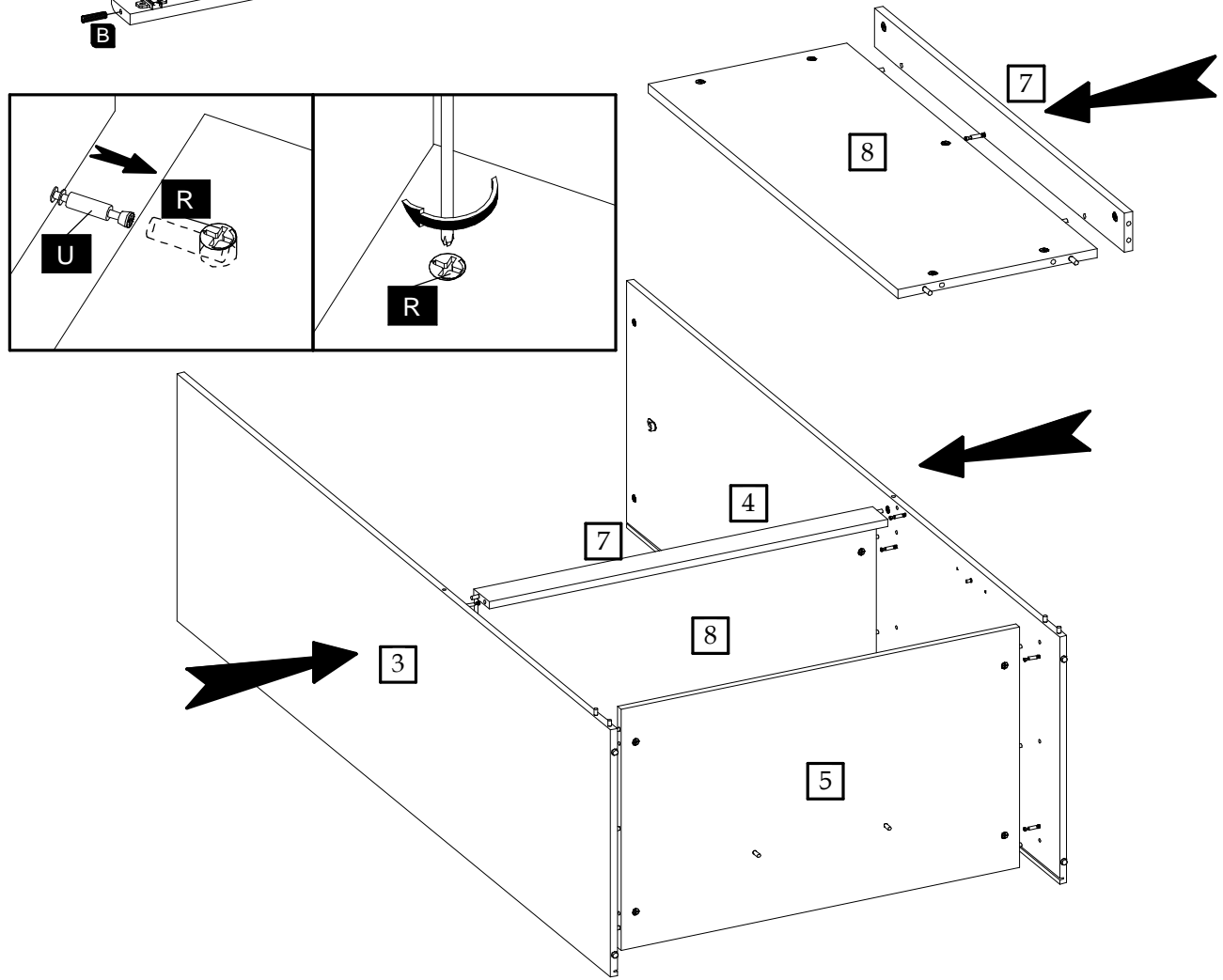

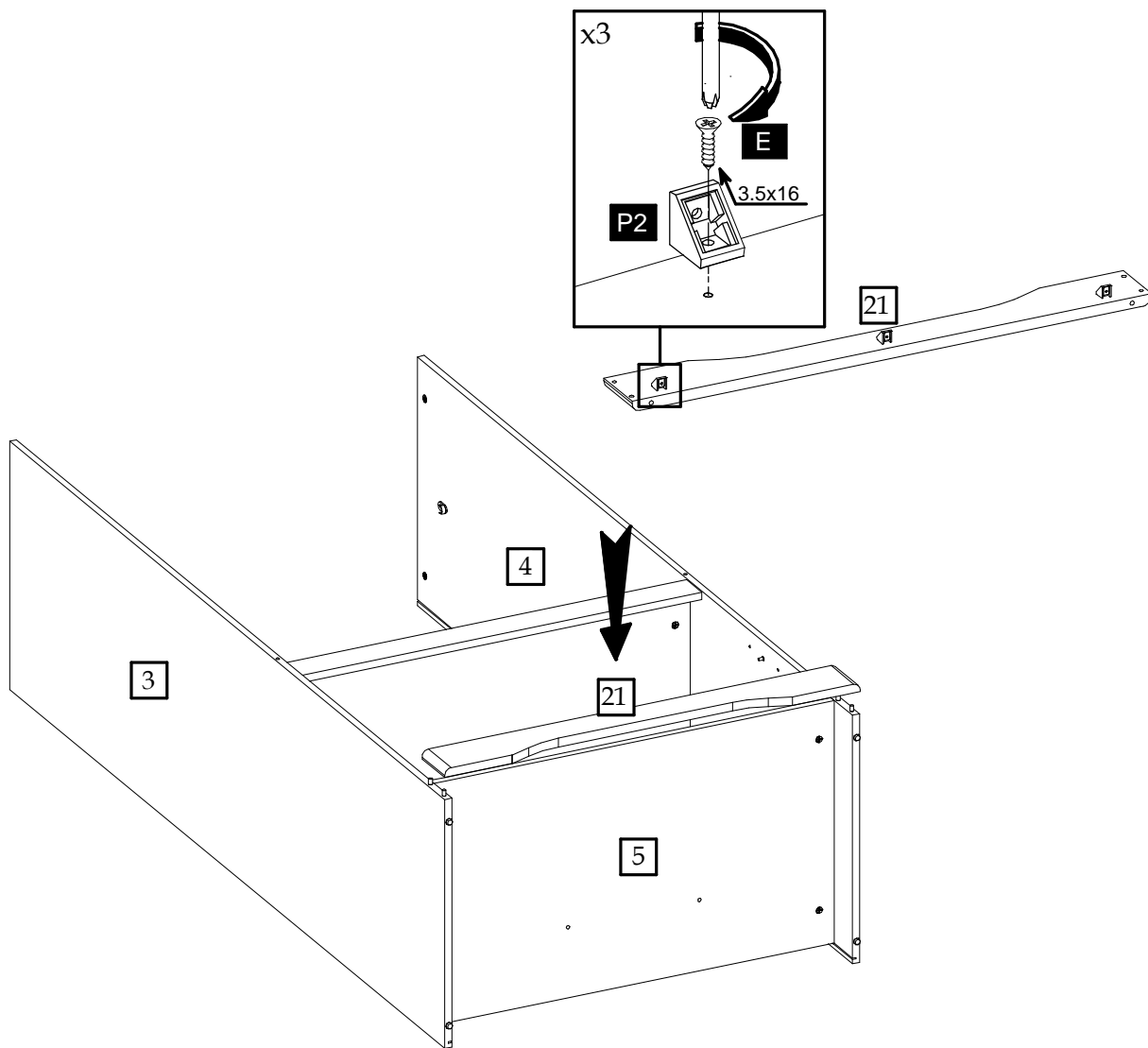

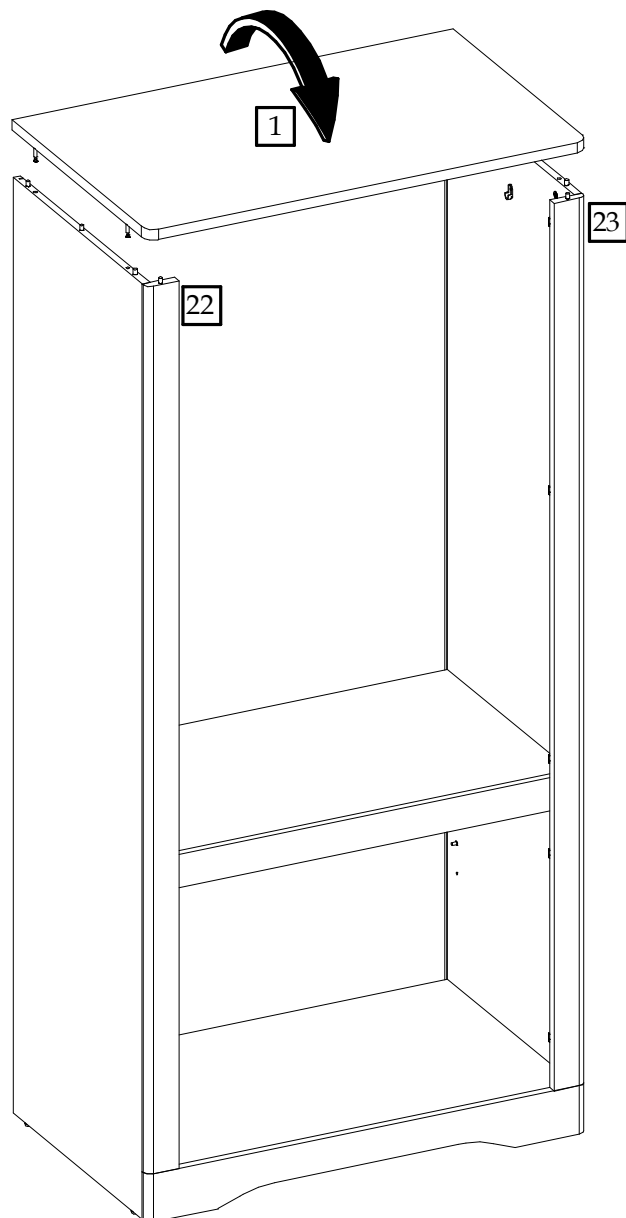
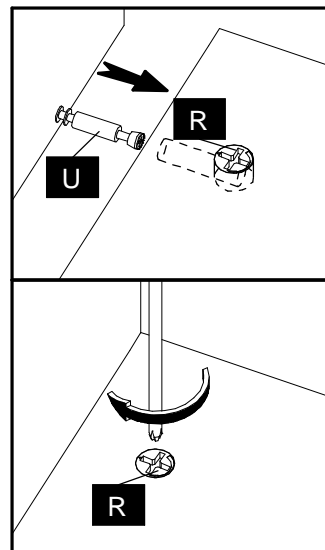
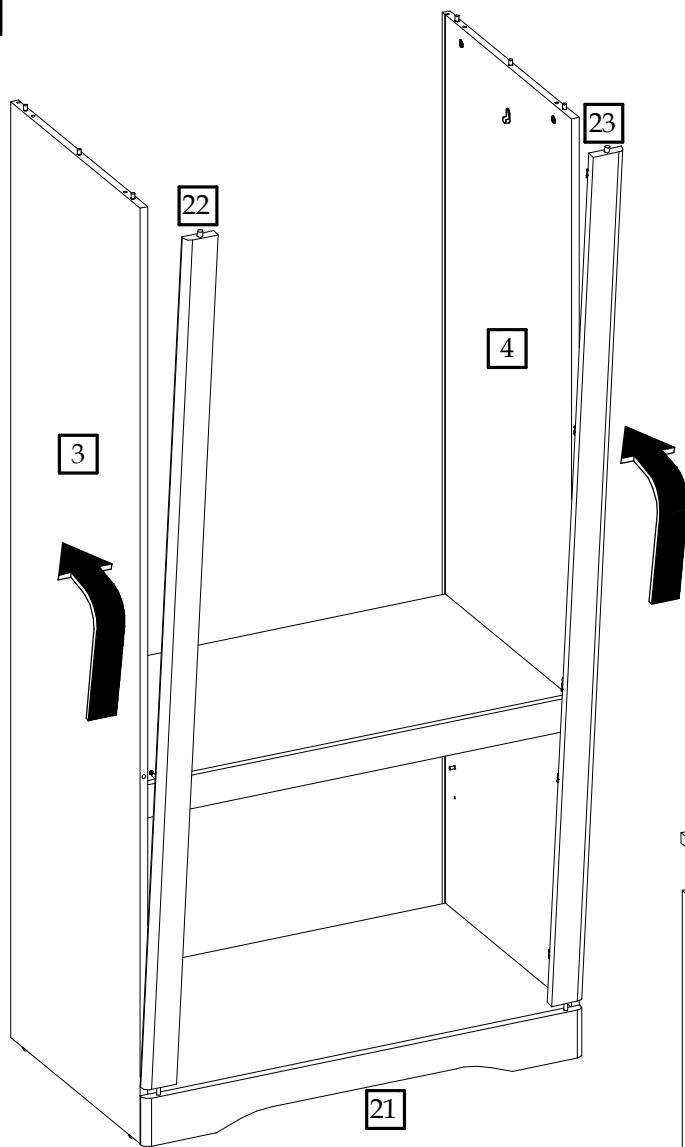

6

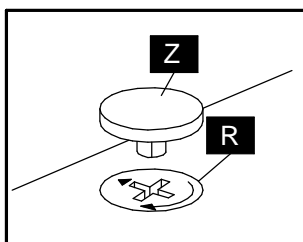
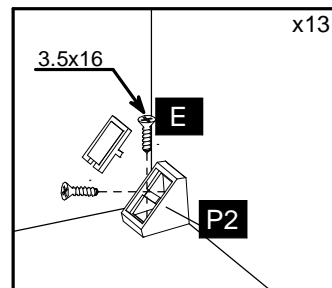
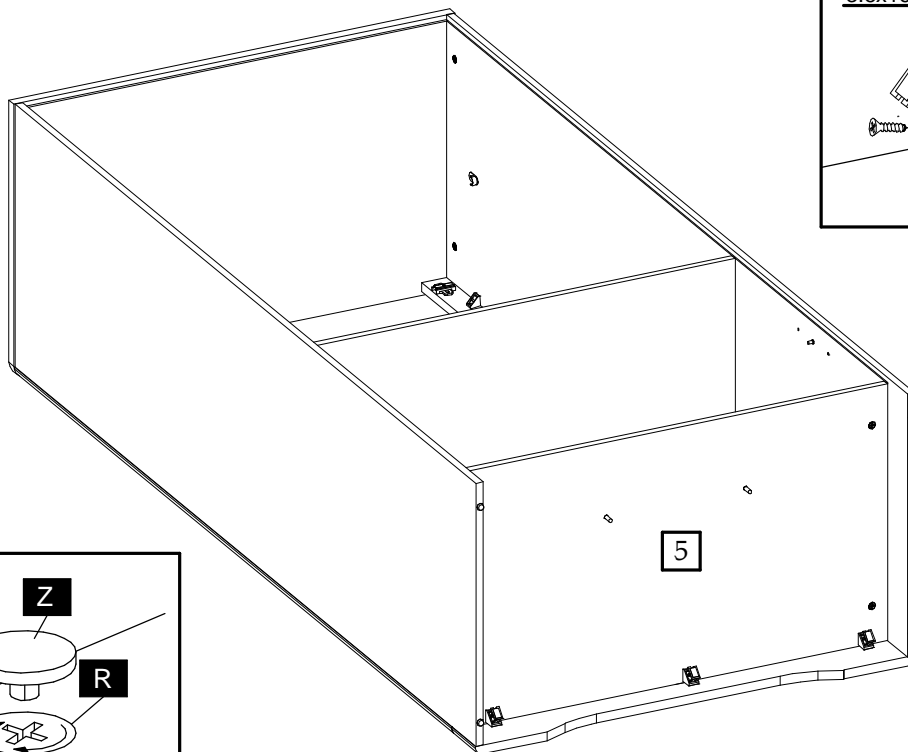

7

