

# Toronto

## Typ V1

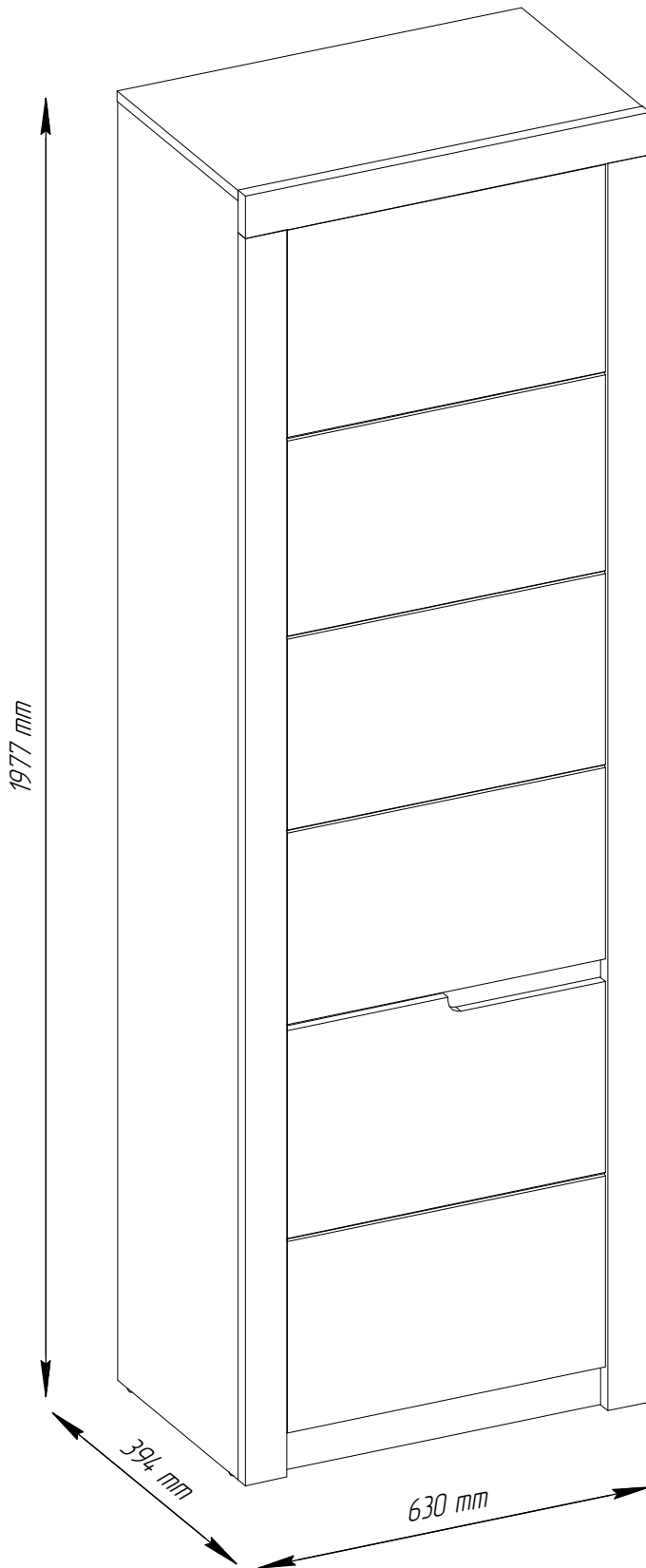

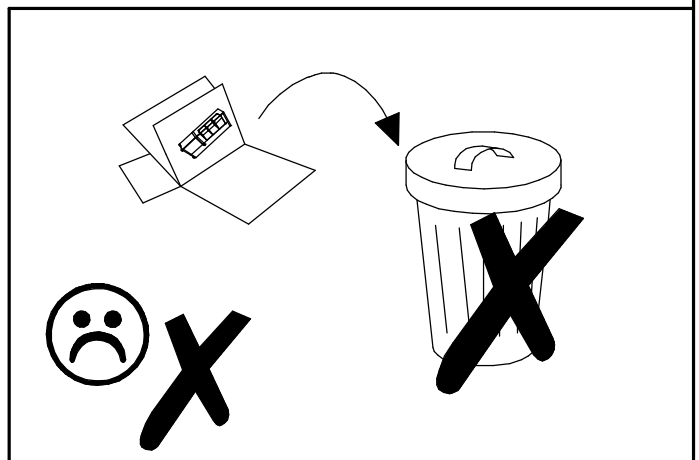

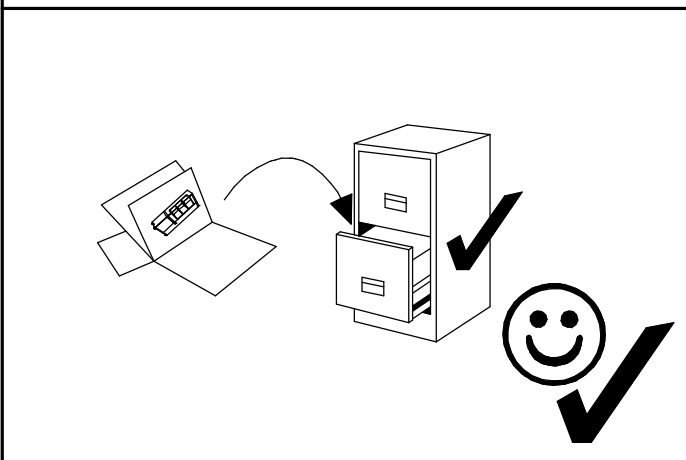
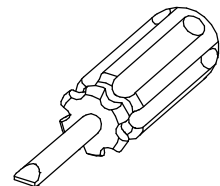
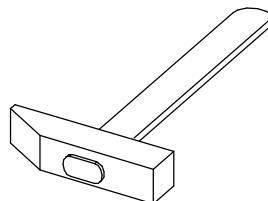
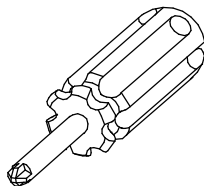
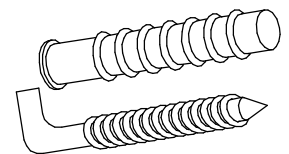
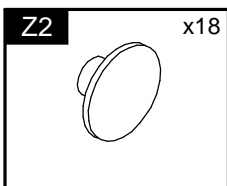
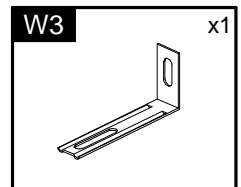
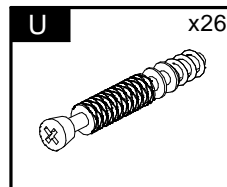
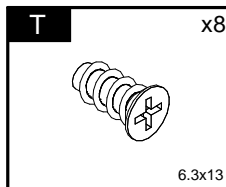
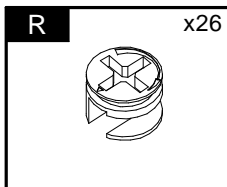
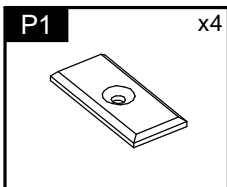
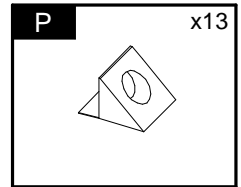
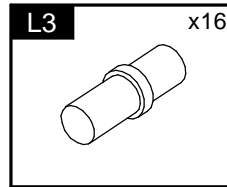
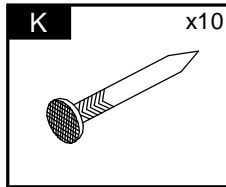
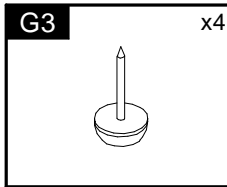
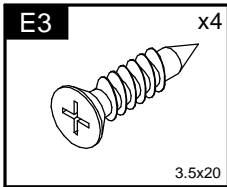
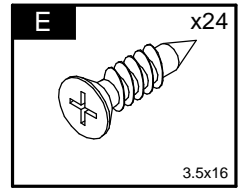
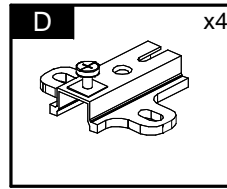
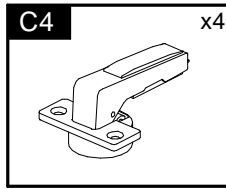
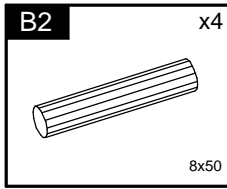
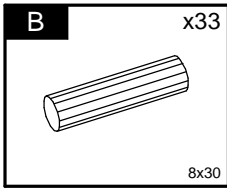
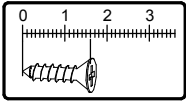

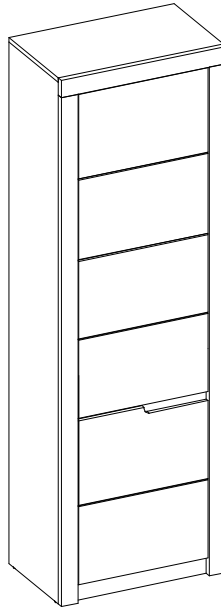

Element symbol	Measurements				Code	Paket
1	1956	375	16	1	1002	1/2
2	1956	375	16	1	1003	1/2
3	630	375	16	1	1004	1/2
4	597	355	16	1	1005	1/2
5	597	65	16	1	1007	1/2
6	597	70	16	1	1039	1/2
7	597	355	16	1	1038	1/2
8	596	345	16	4	N/A	1/2
9	597	65	16	1	1001	1/2
10	1246	611	3	1	N/A	1/2
11	650	611	3	1	N/A	1/2
12	617	497	16	1	3025	2/2
13	1217	497	16	1	3045	2/2
14	630	65	19	1	4001	1/2
15	1907.5	65	19	1	4002	1/2
16	1907.5	65	19	1	4003	1/2

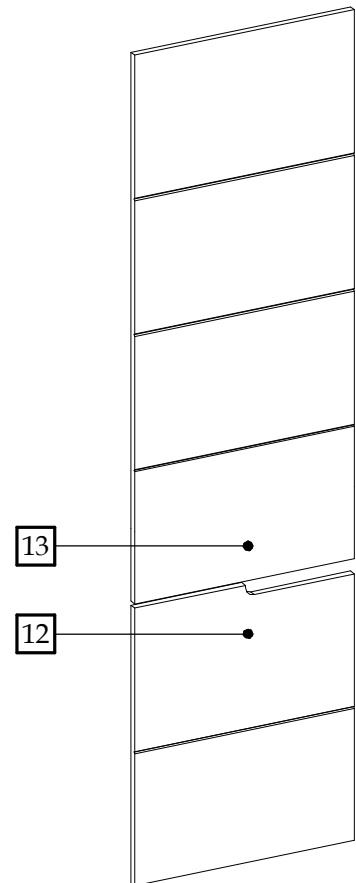
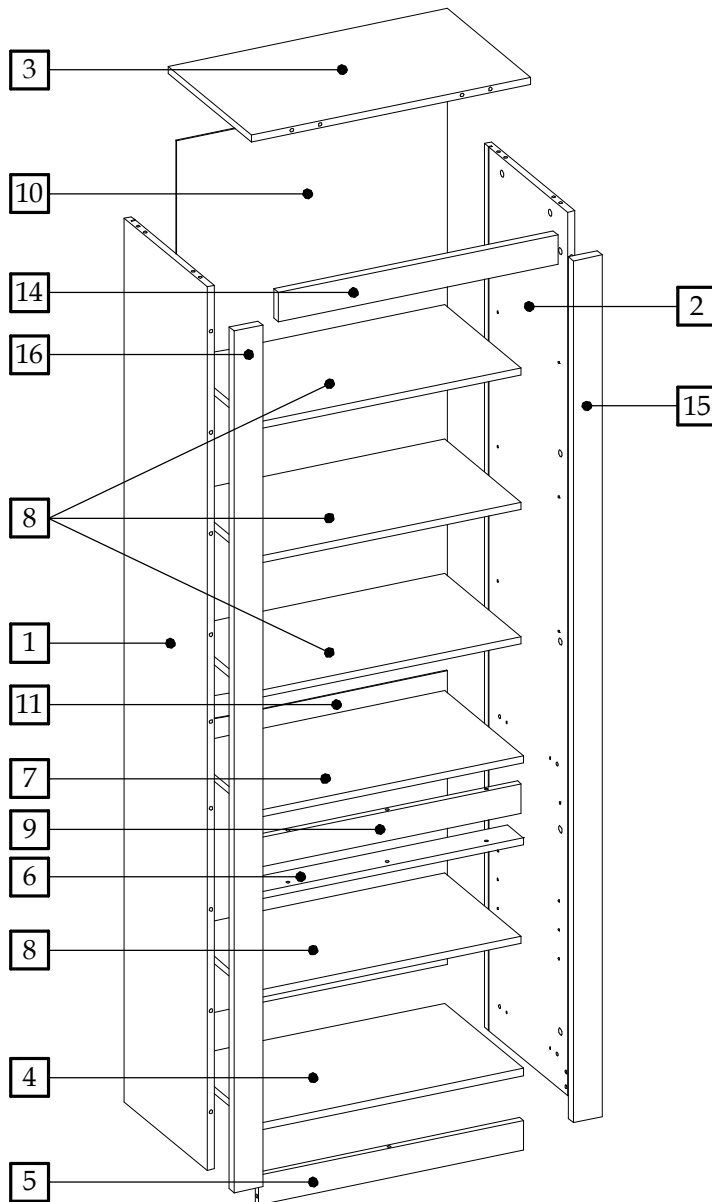

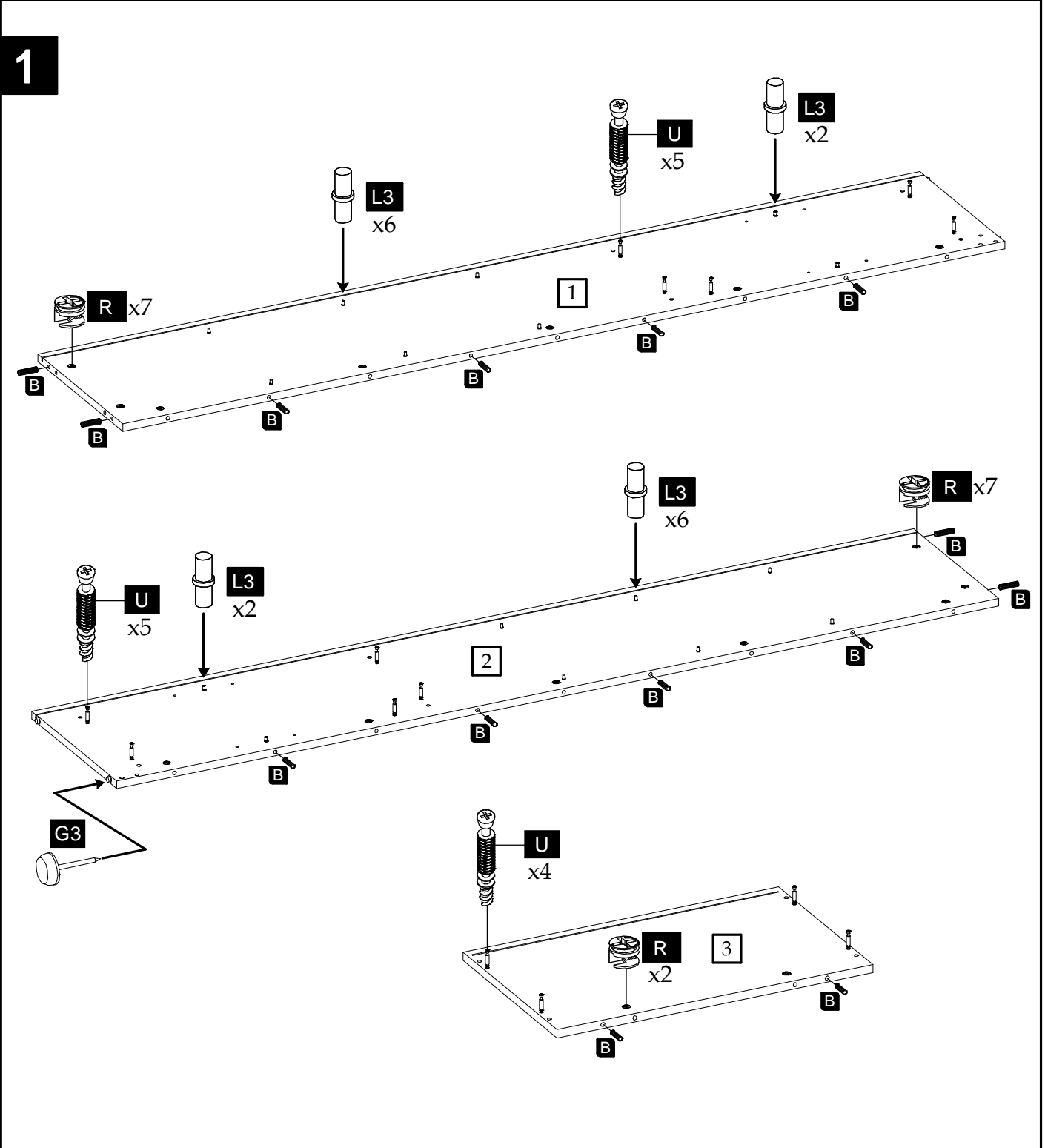

2

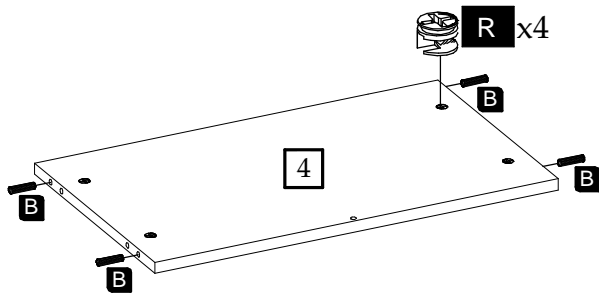
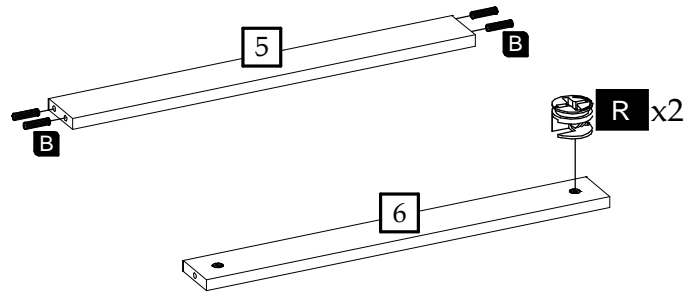
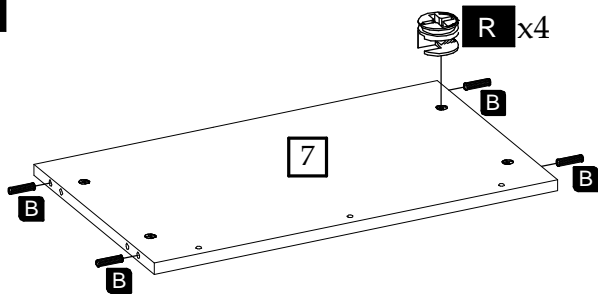

3

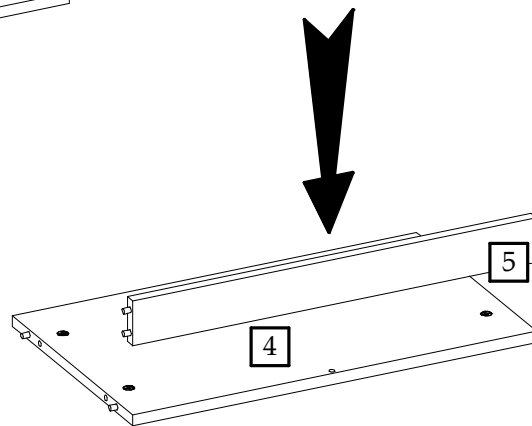
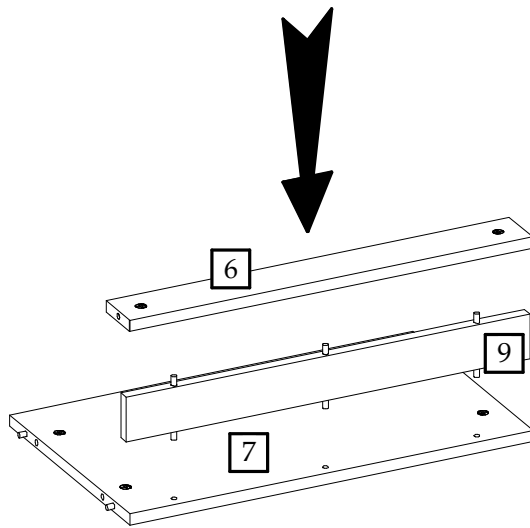

4

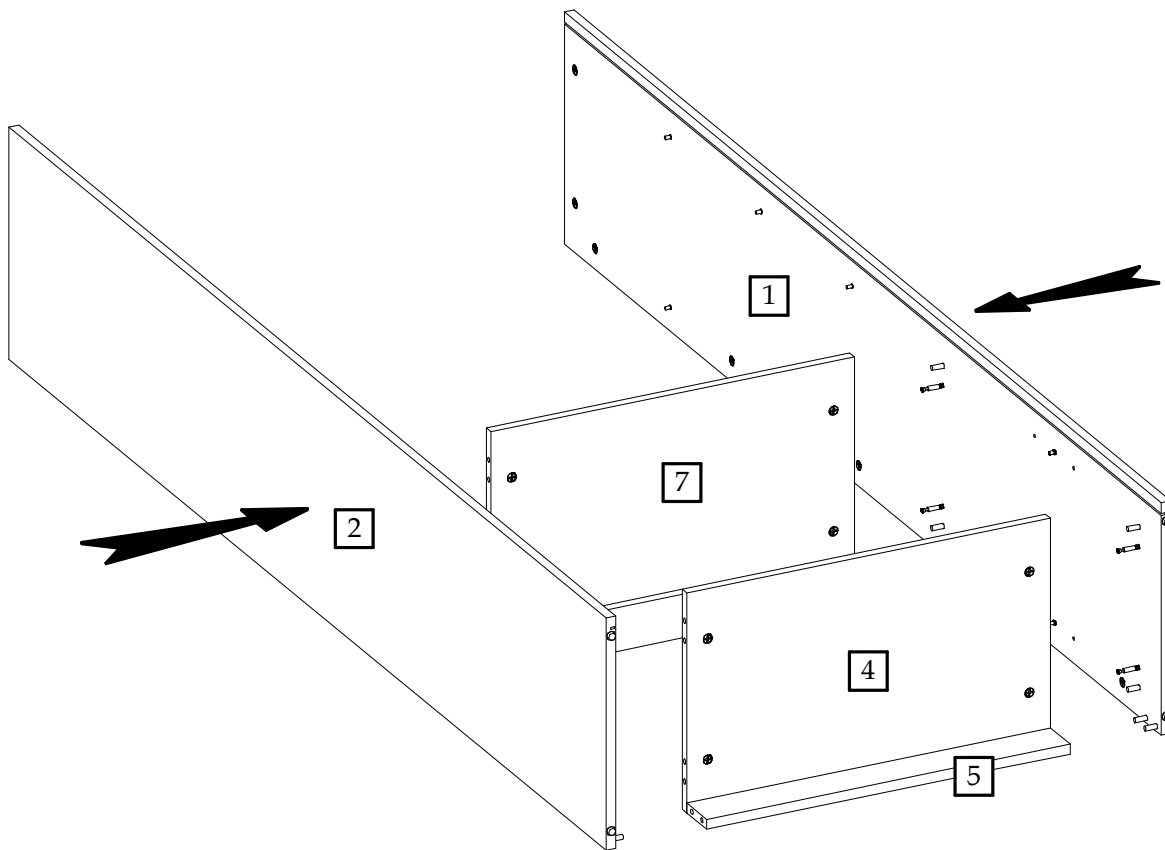

5

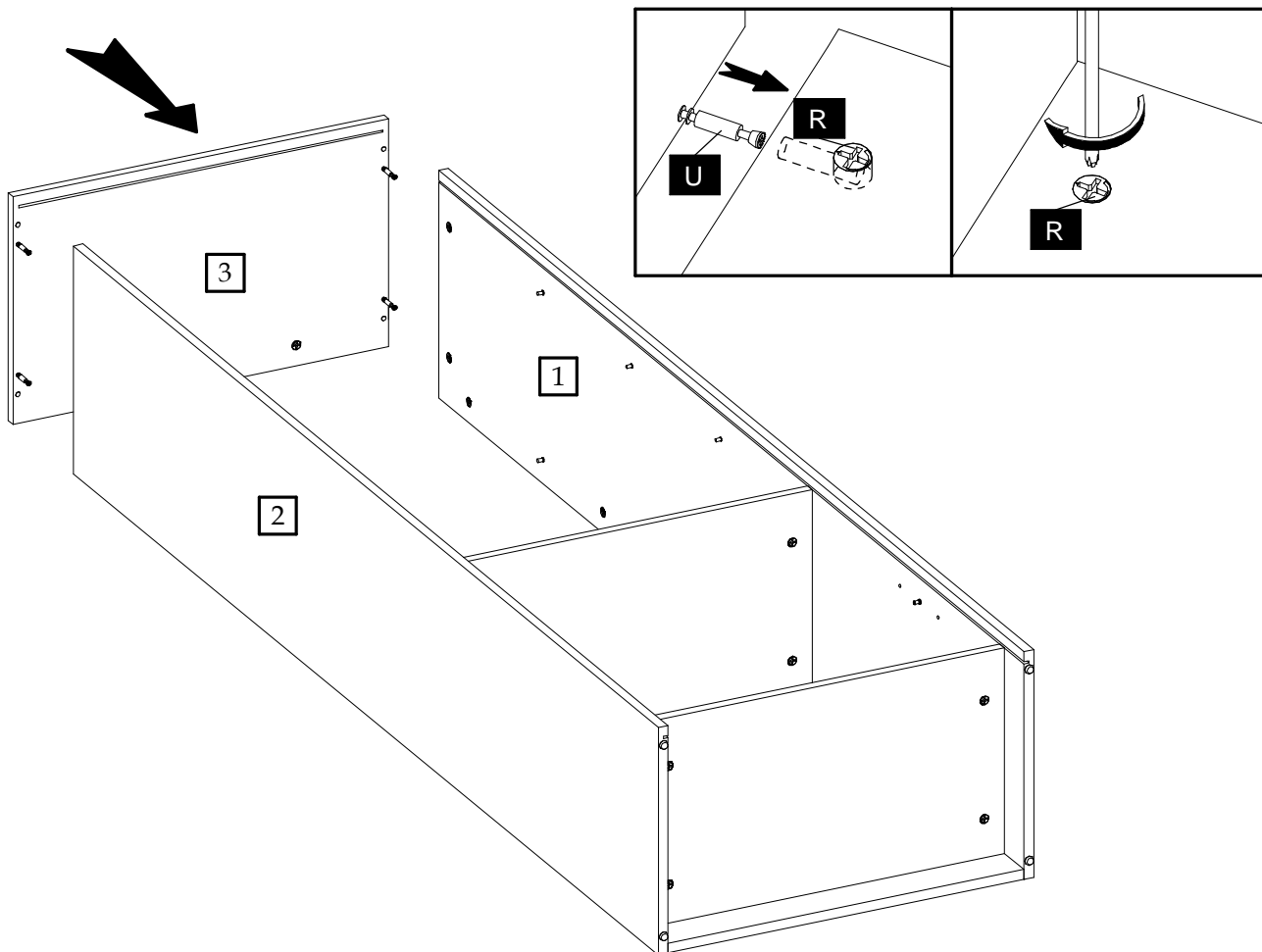

6

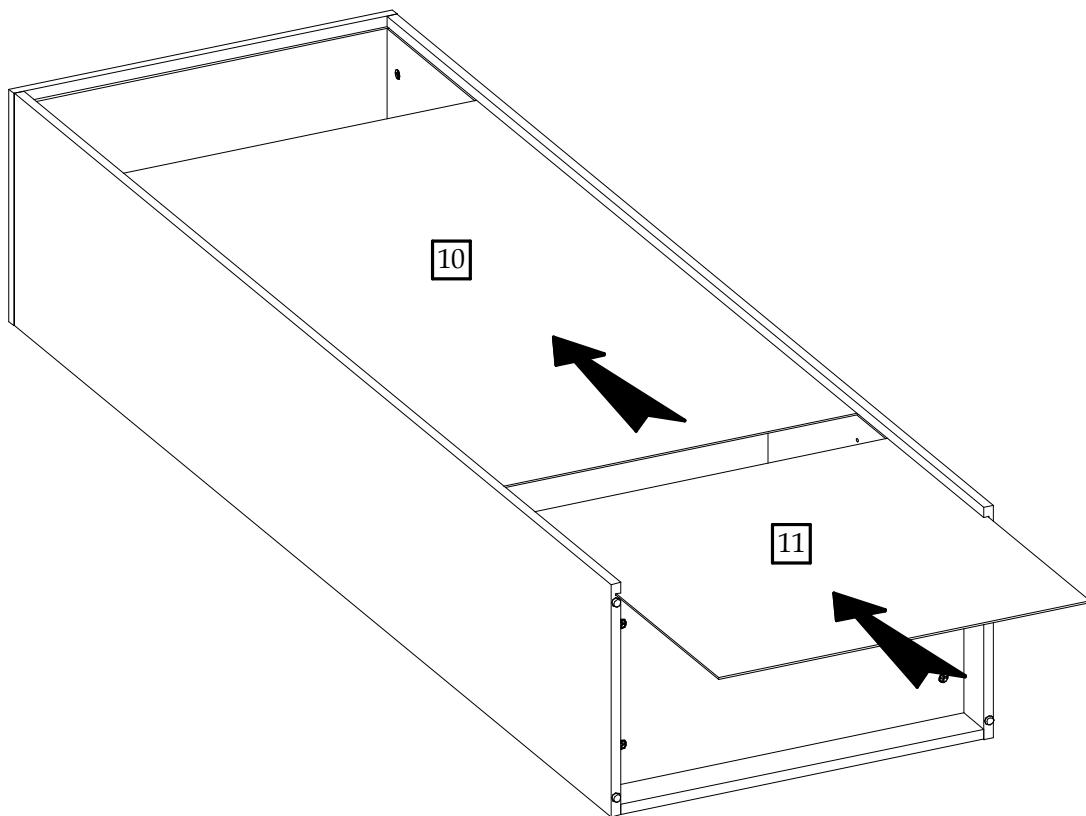

7

