

Adam

Typ B

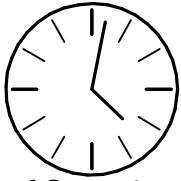

60 min

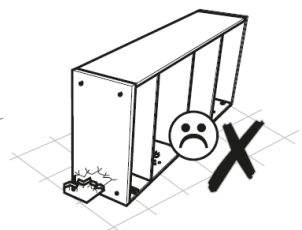
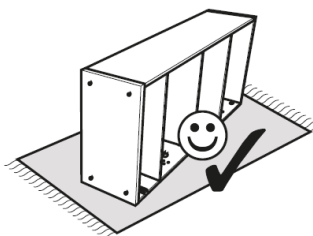
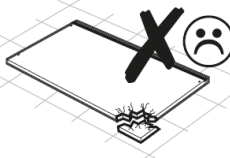
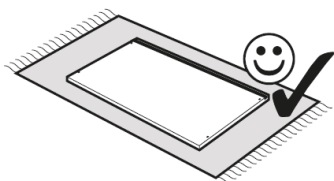
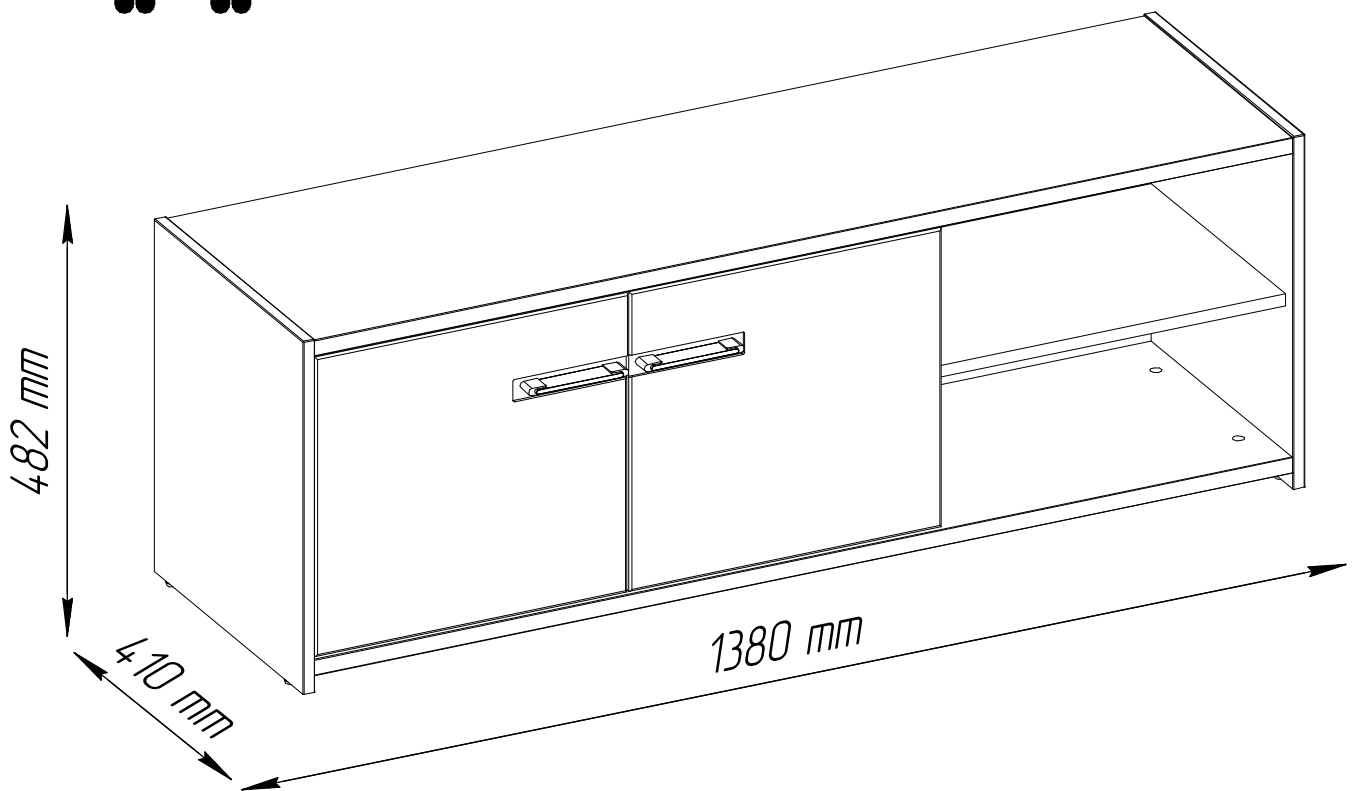
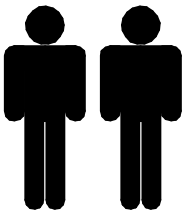

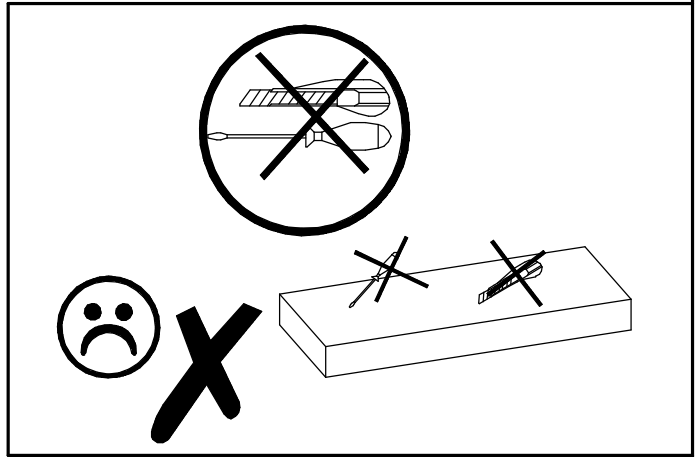
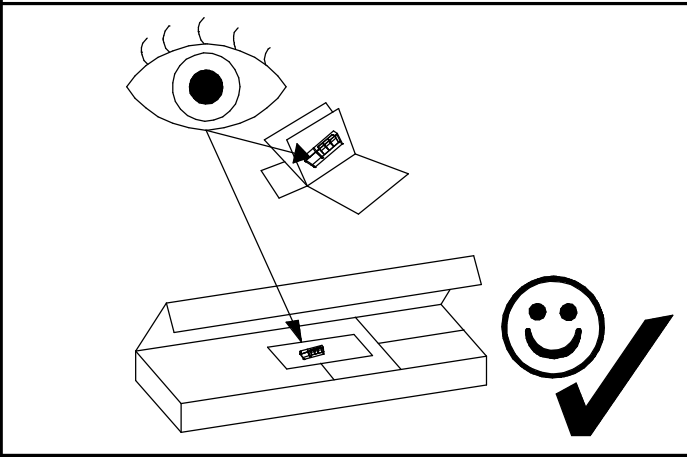
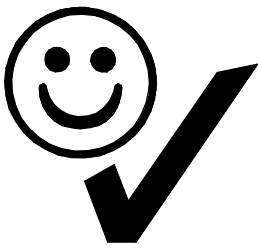

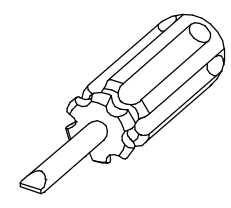
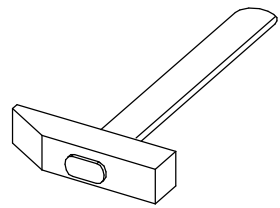
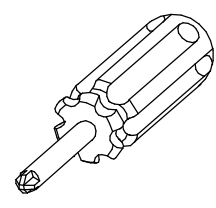
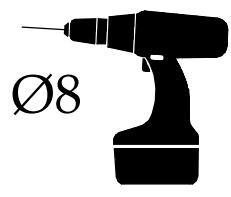
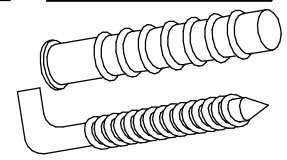
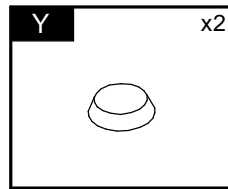
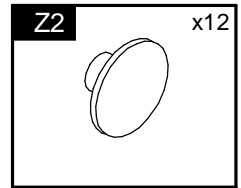
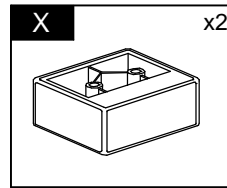
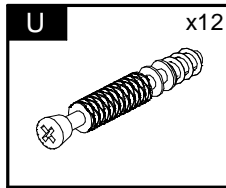
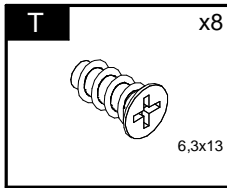
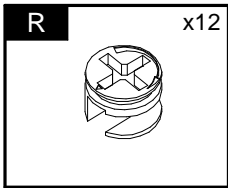
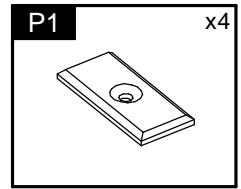
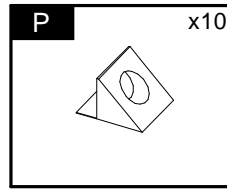
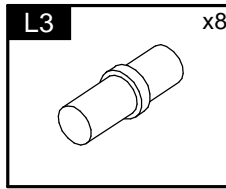
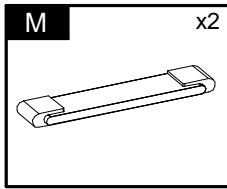
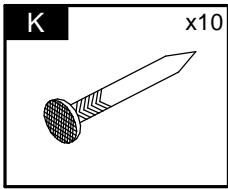
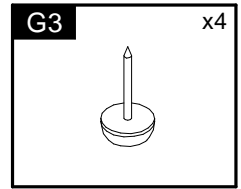
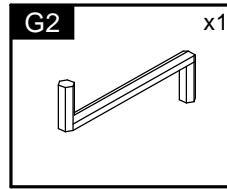
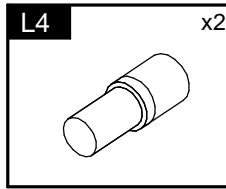
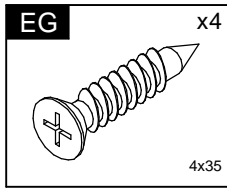
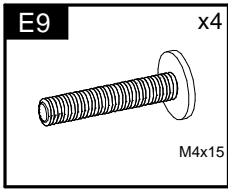
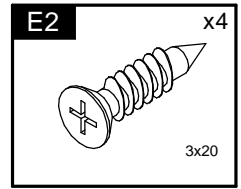
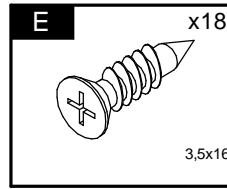
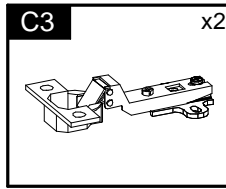
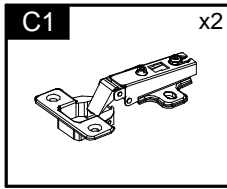
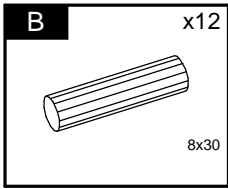
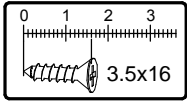
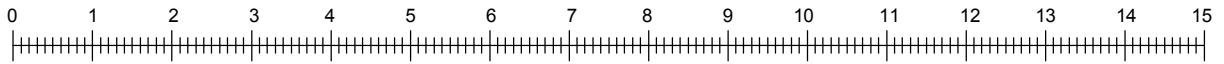

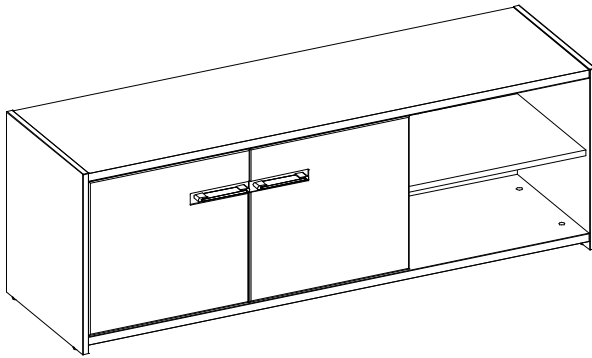

Element symbol	Measurements				Code	Paket
1	1348	407.5	22	1	1005	1/2
2	1348	387.5	22	1	1004/2004	1/2
3	477	409.5	16	1	1002	1/2
4	477	409.5	16	1	1003	1/2
5	410	369.5	16	1	1009	1/2
6	852	368.5	16	1	N/A	1/2
7	480	368.5	16	1	N/A	1/2
8	867	438	3	1	N/A	1/2
9	495	438	3	1	1035_v	1/2
10	407	432	16	1	1011/3001	2/2
11	407	432	16	1	1012/3002	2/2

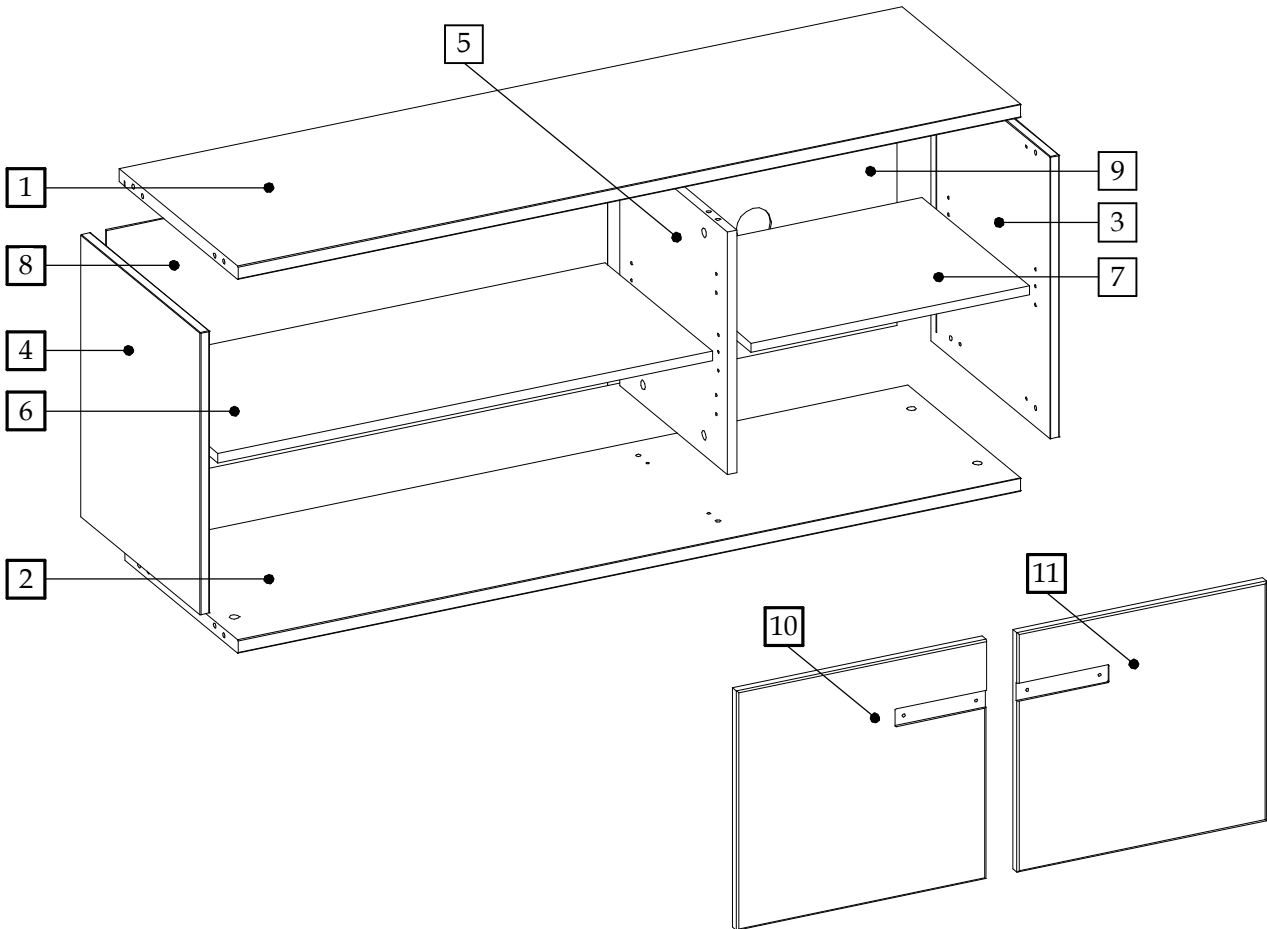

2

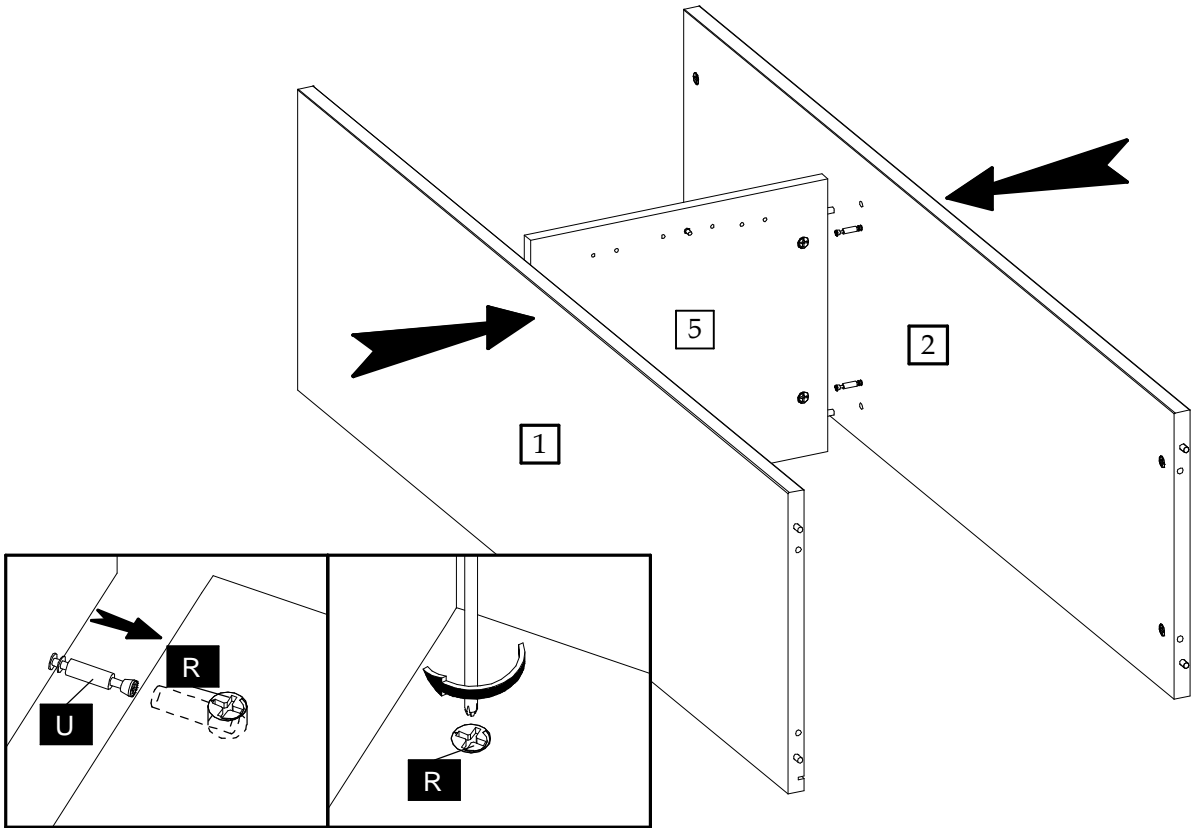

3

