

Adam

Typ D

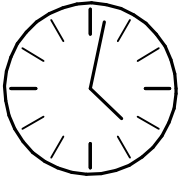

30 min

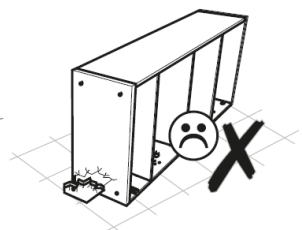
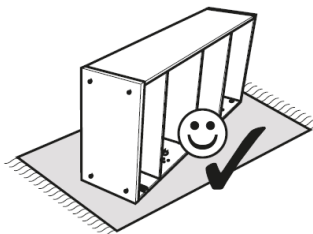
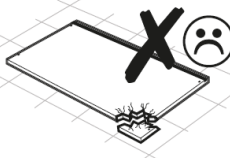
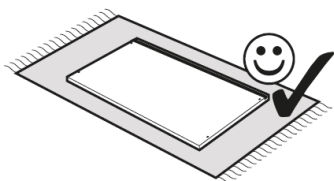
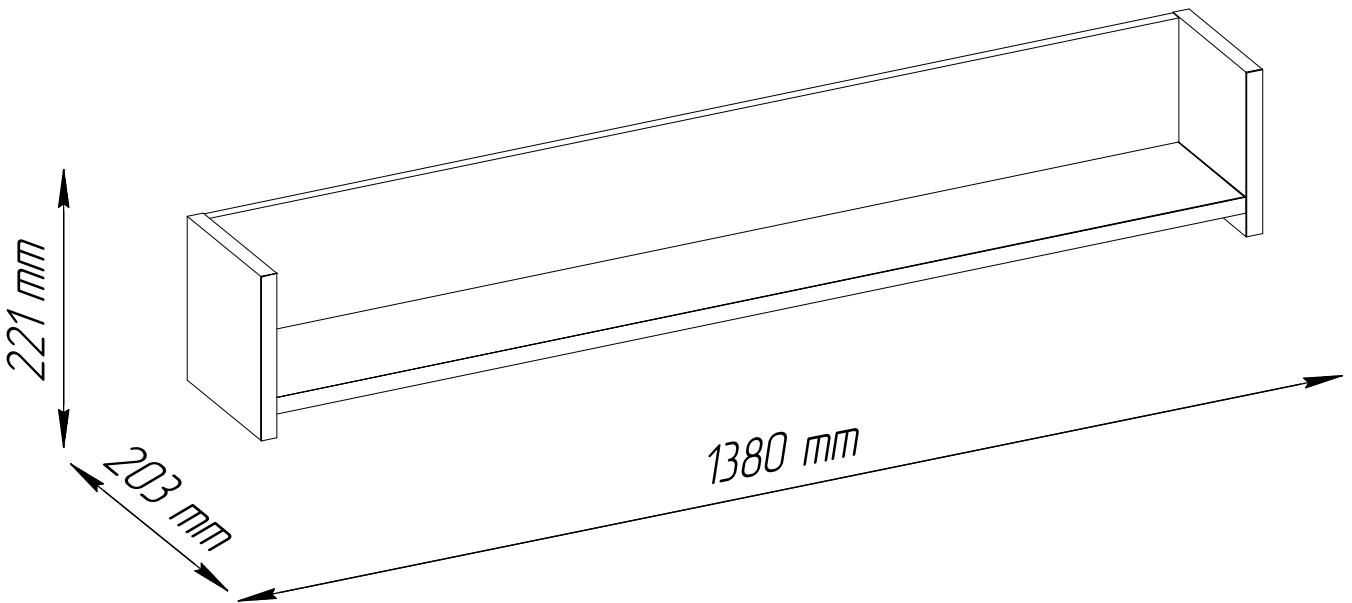
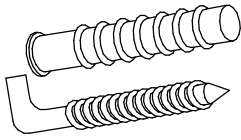
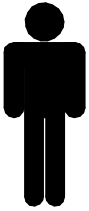

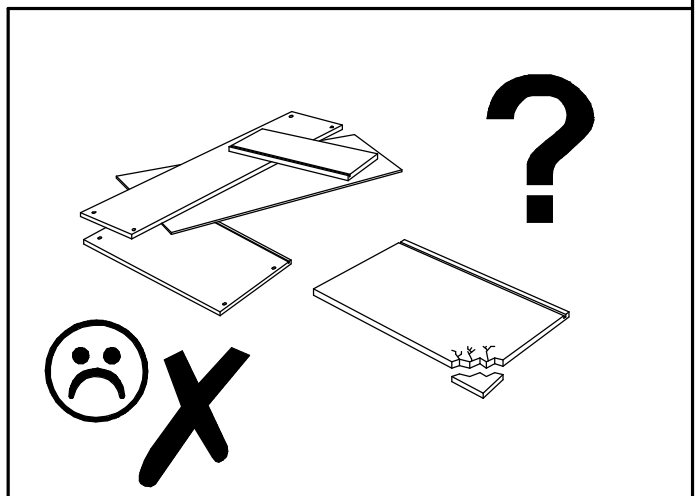
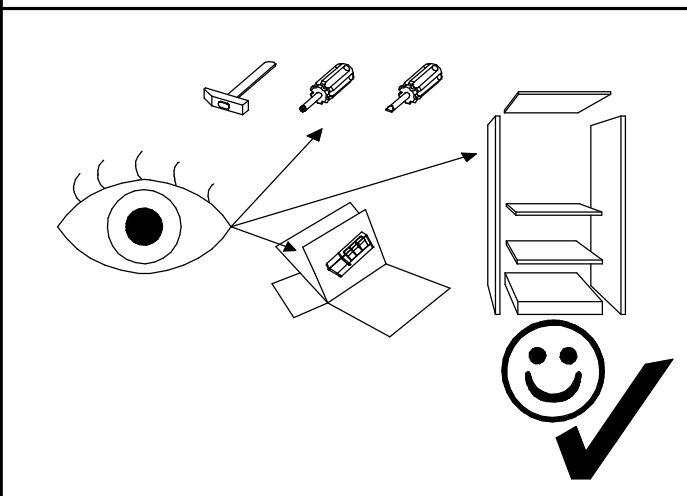
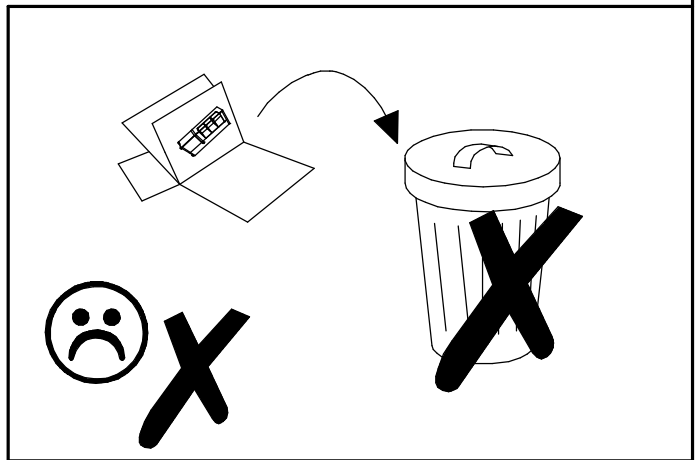
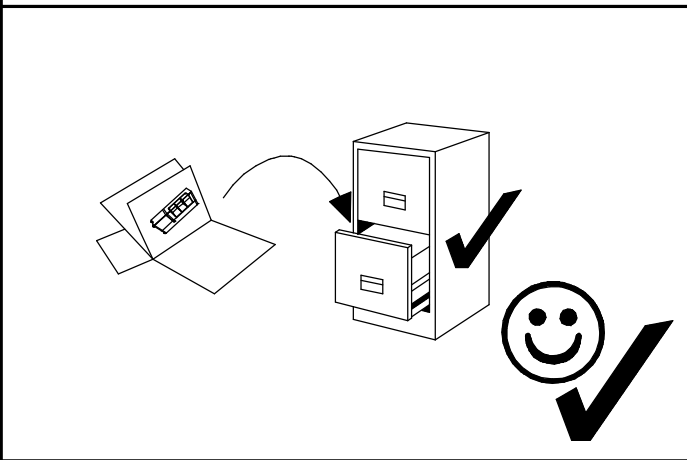
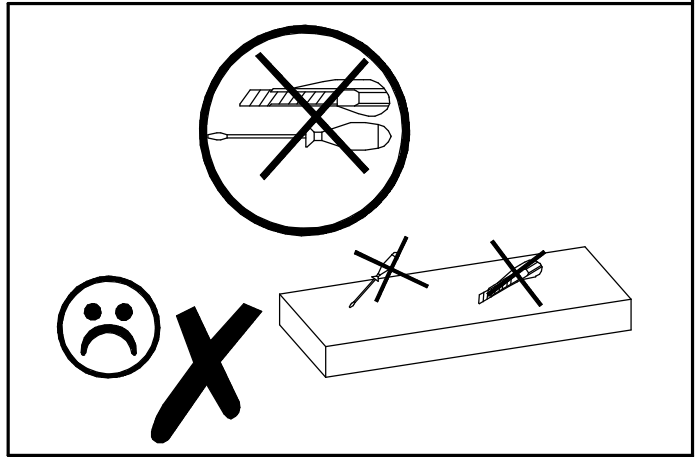
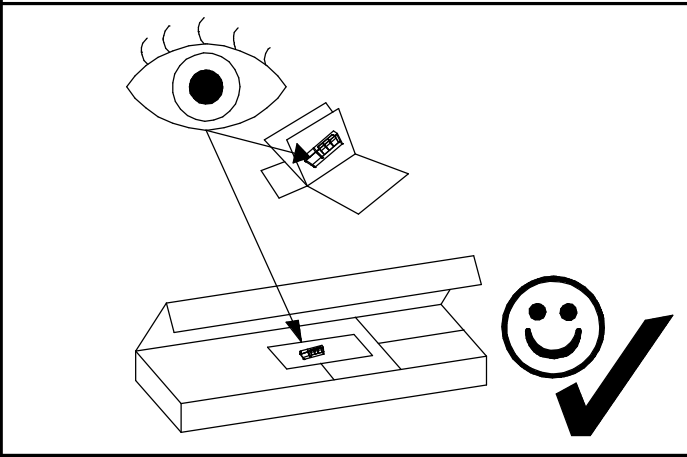

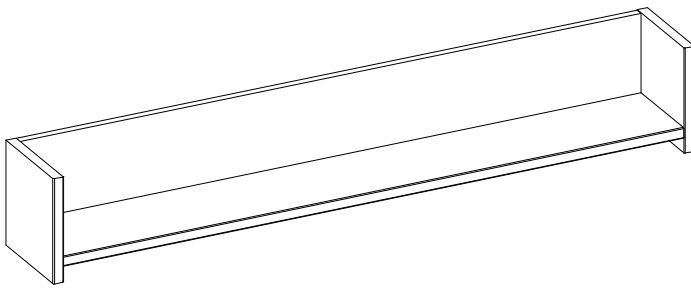
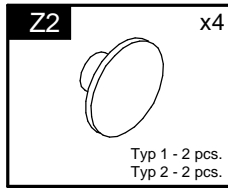
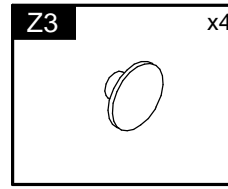
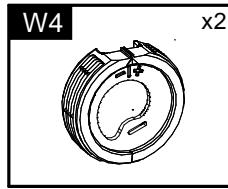
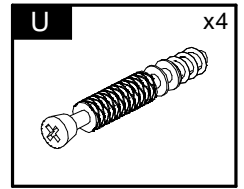
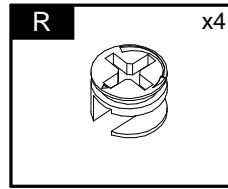
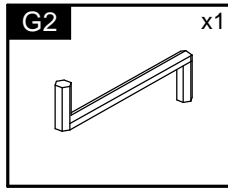
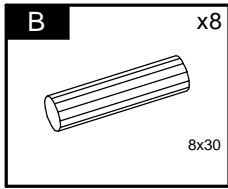
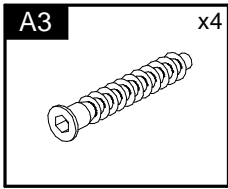
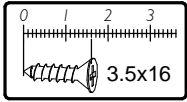
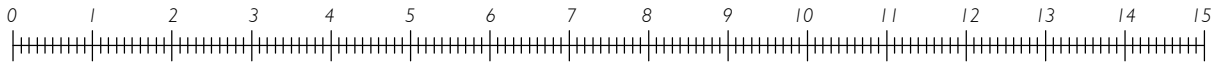

Element symbol	Measurements				Code	Paket
	1	2	3	4		
1	1336	184	22	1	1001	1/1
2	222	202.5	22	1	1002	1/1
3	222	202.5	22	1	1003	1/1
4	1336	220	16	1	1004	1/1

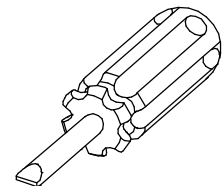
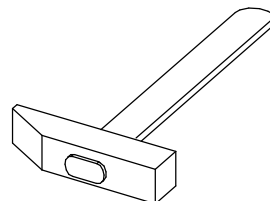
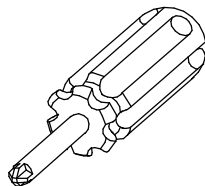
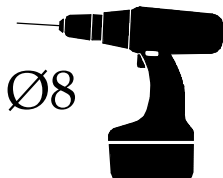
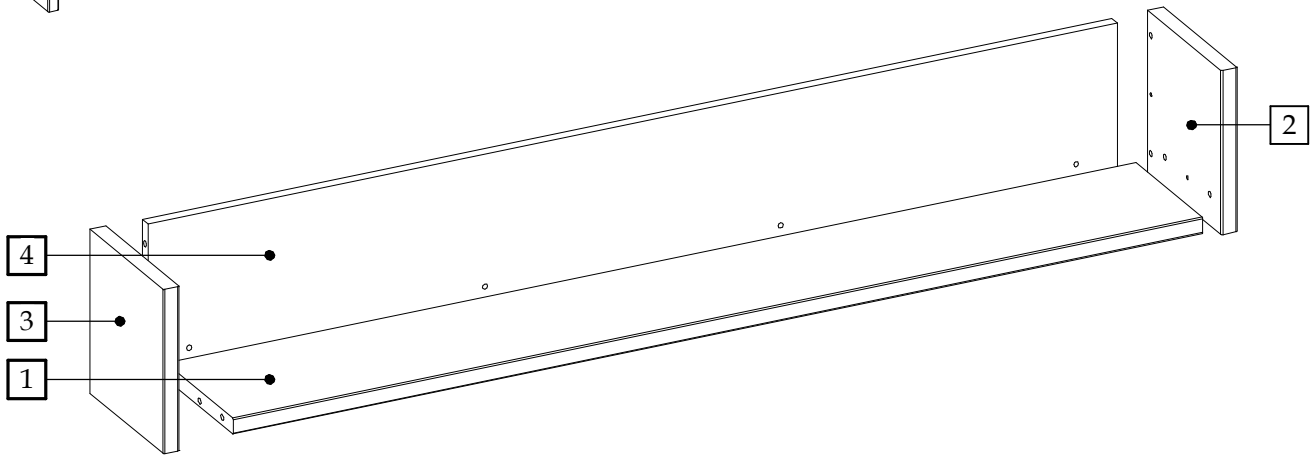

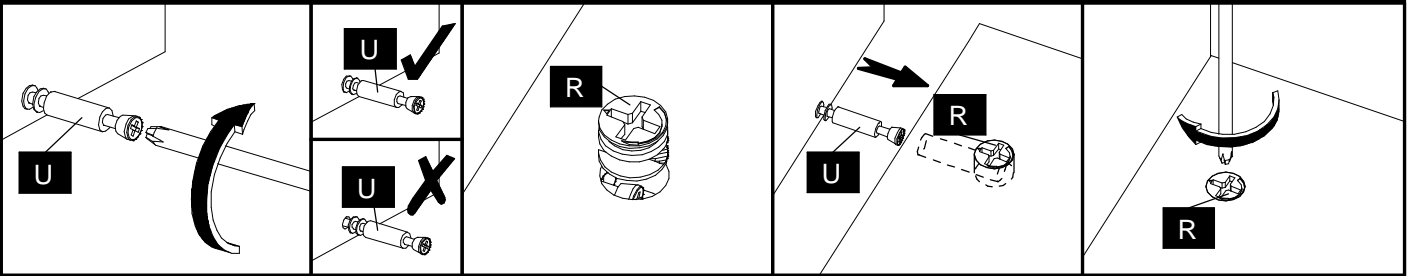

1

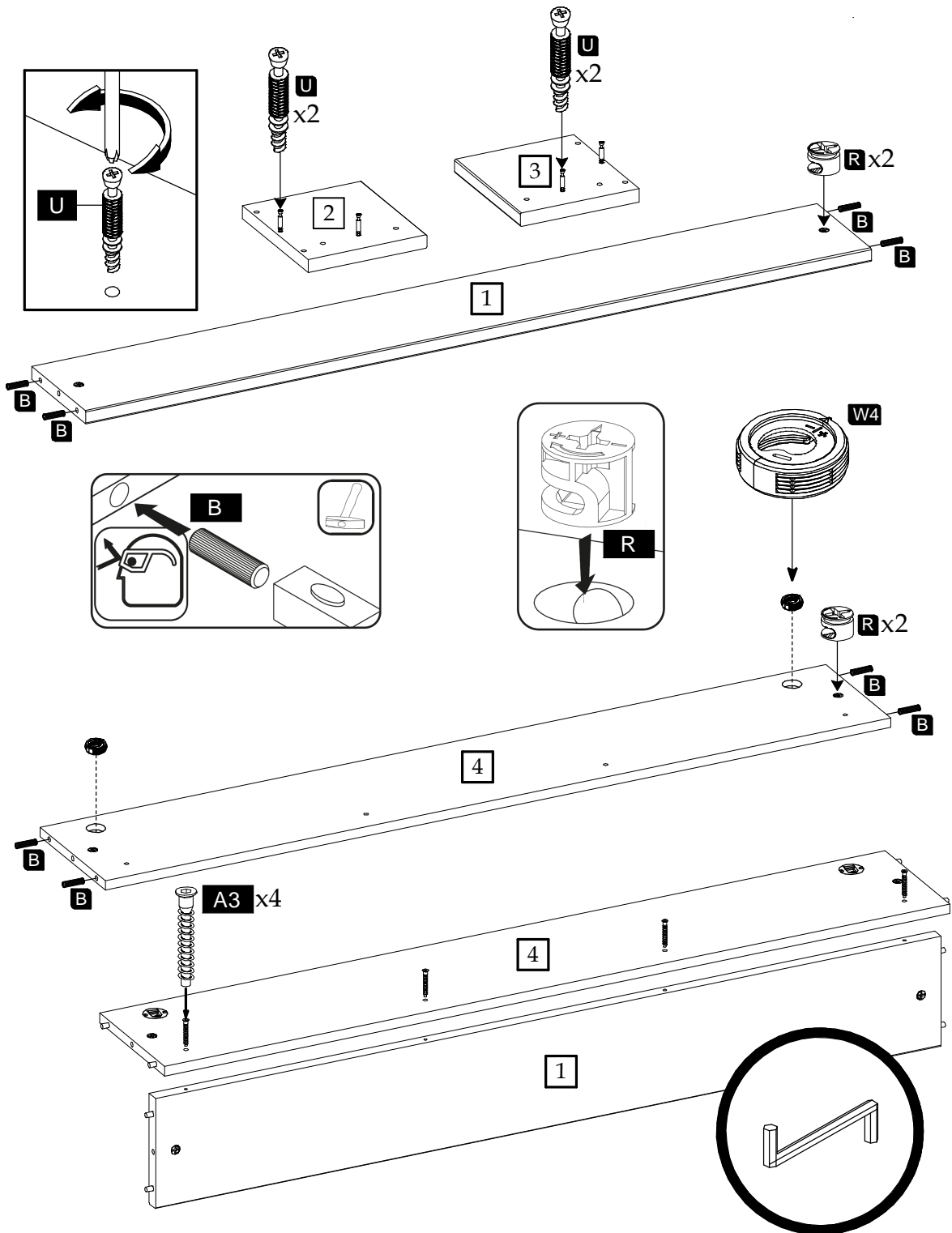

2

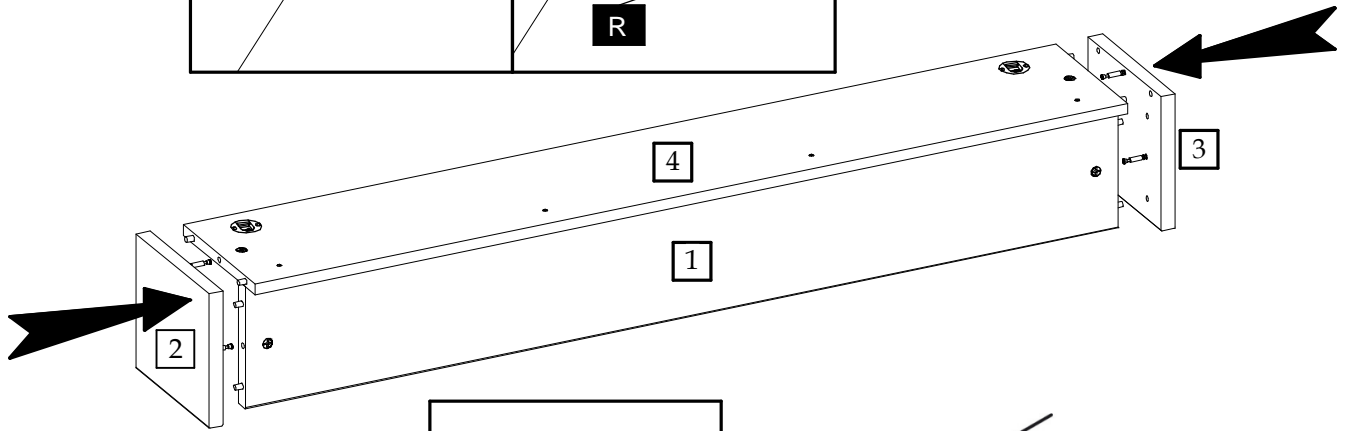
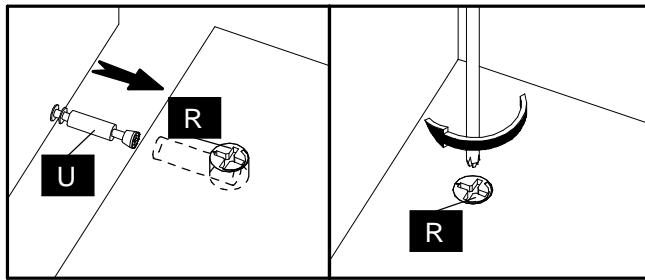

3

