

# Adam

## Typ I

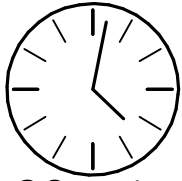

90 min

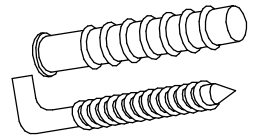
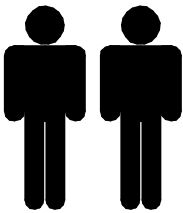

1617 mm

410 mm

900 mm

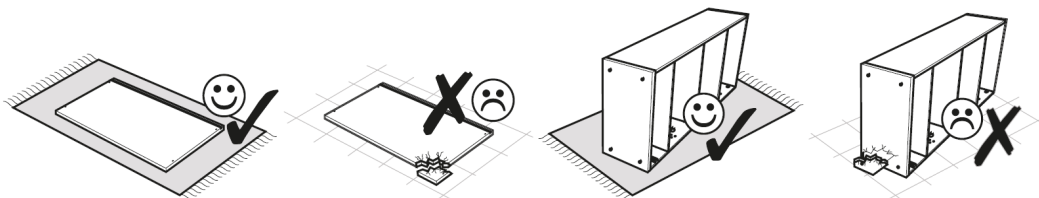

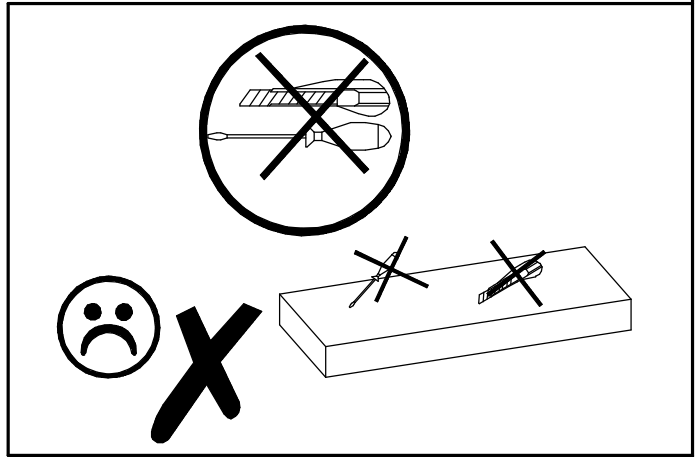
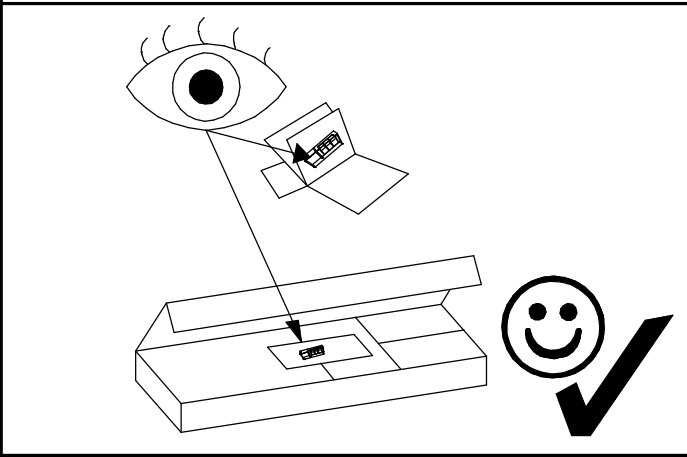

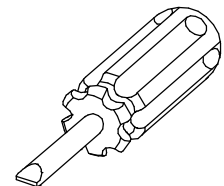
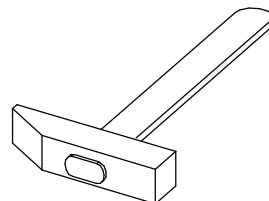
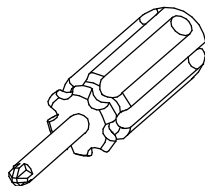
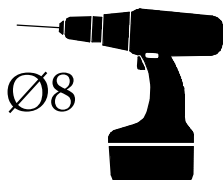
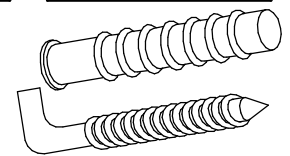
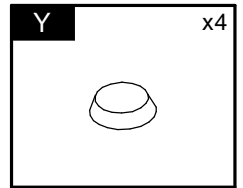
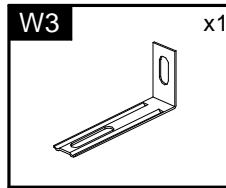
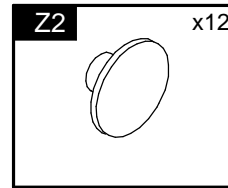
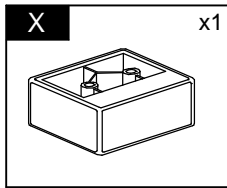
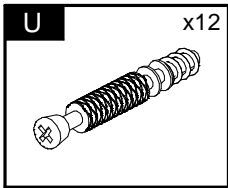
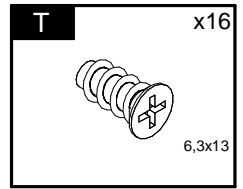
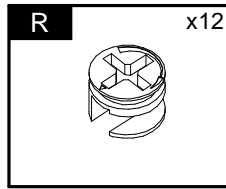
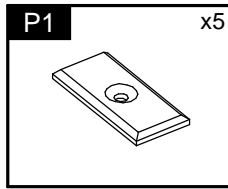
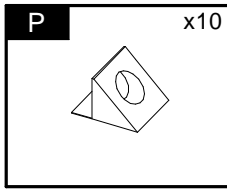
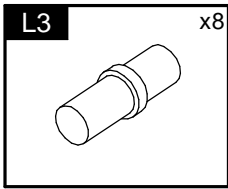
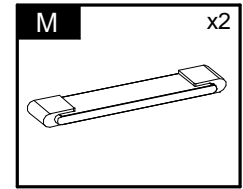
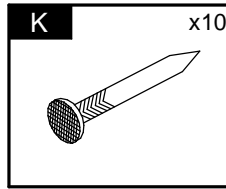
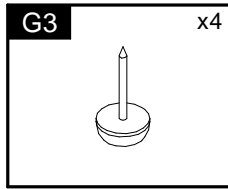
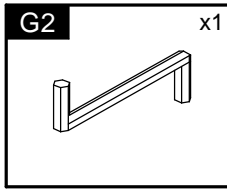
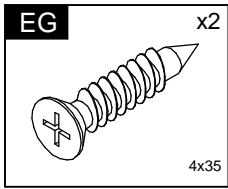
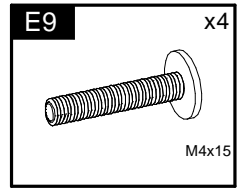
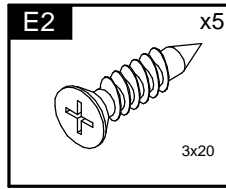
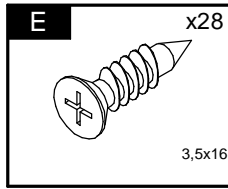
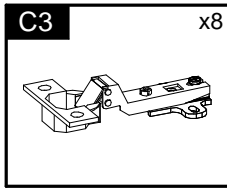
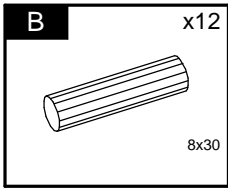
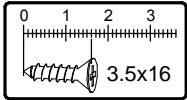

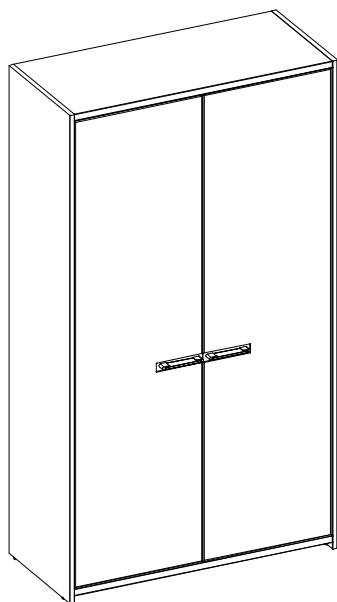

Element symbol	Measurements				Code	Paket
1	868	407.5	22	1	1005	1/2
2	868	387.5	22	1	1004/2004	1/2
3	1612	409.5	16	1	1002	1/2
4	1612	409.5	16	1	1003	1/2
5	868	368.5	16	1	1016	1/2
6	868	368.5	16	1	N/A	1/2
7	868	368.5	16	1	N/A	1/2
8	882	365	3	1	1020_v	1/2
9	1209	441	3	2	N/A	2/2
10	1543	432	16	1	1007/3001	2/2
11	1543	432	16	1	1008/3002	2/2

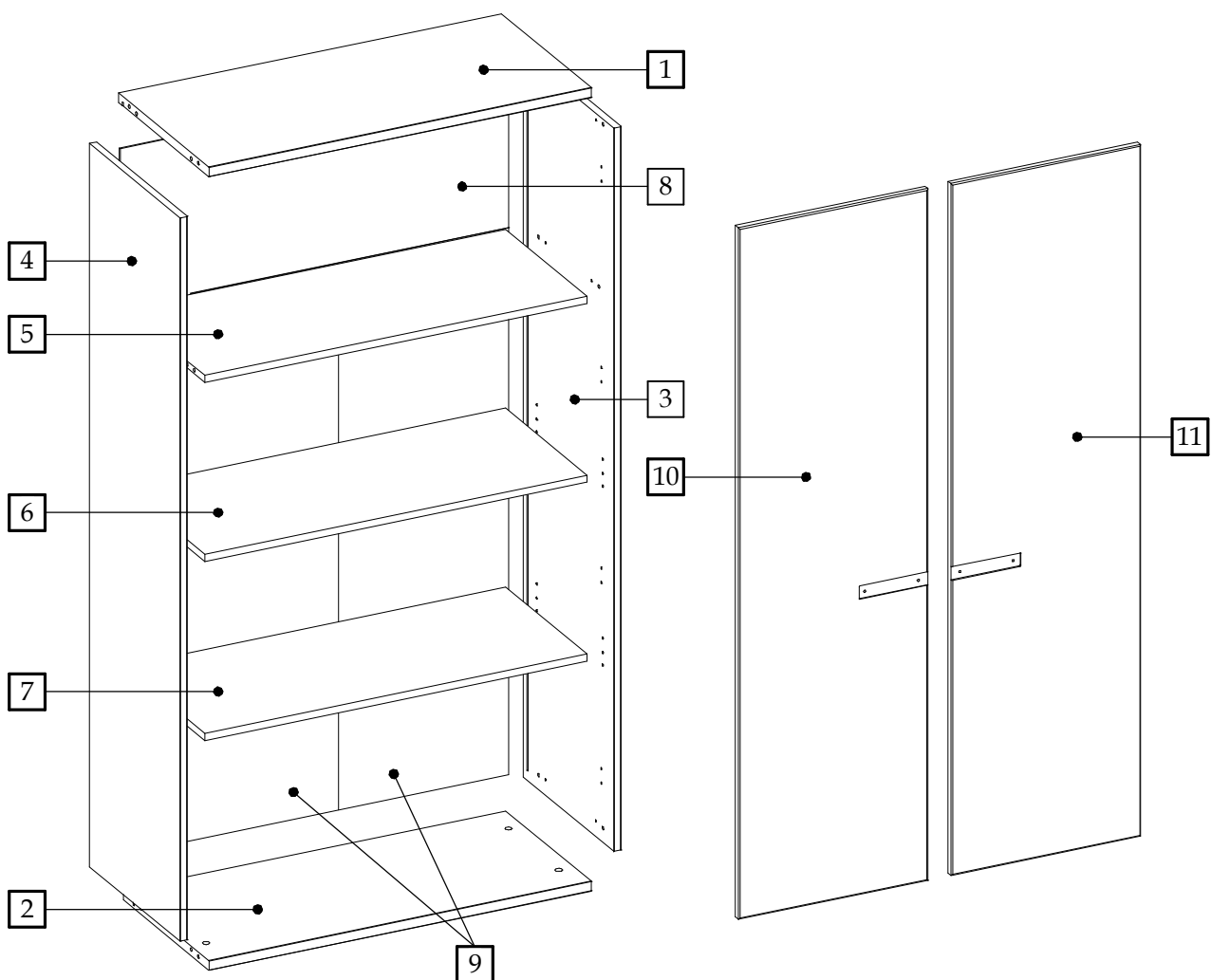

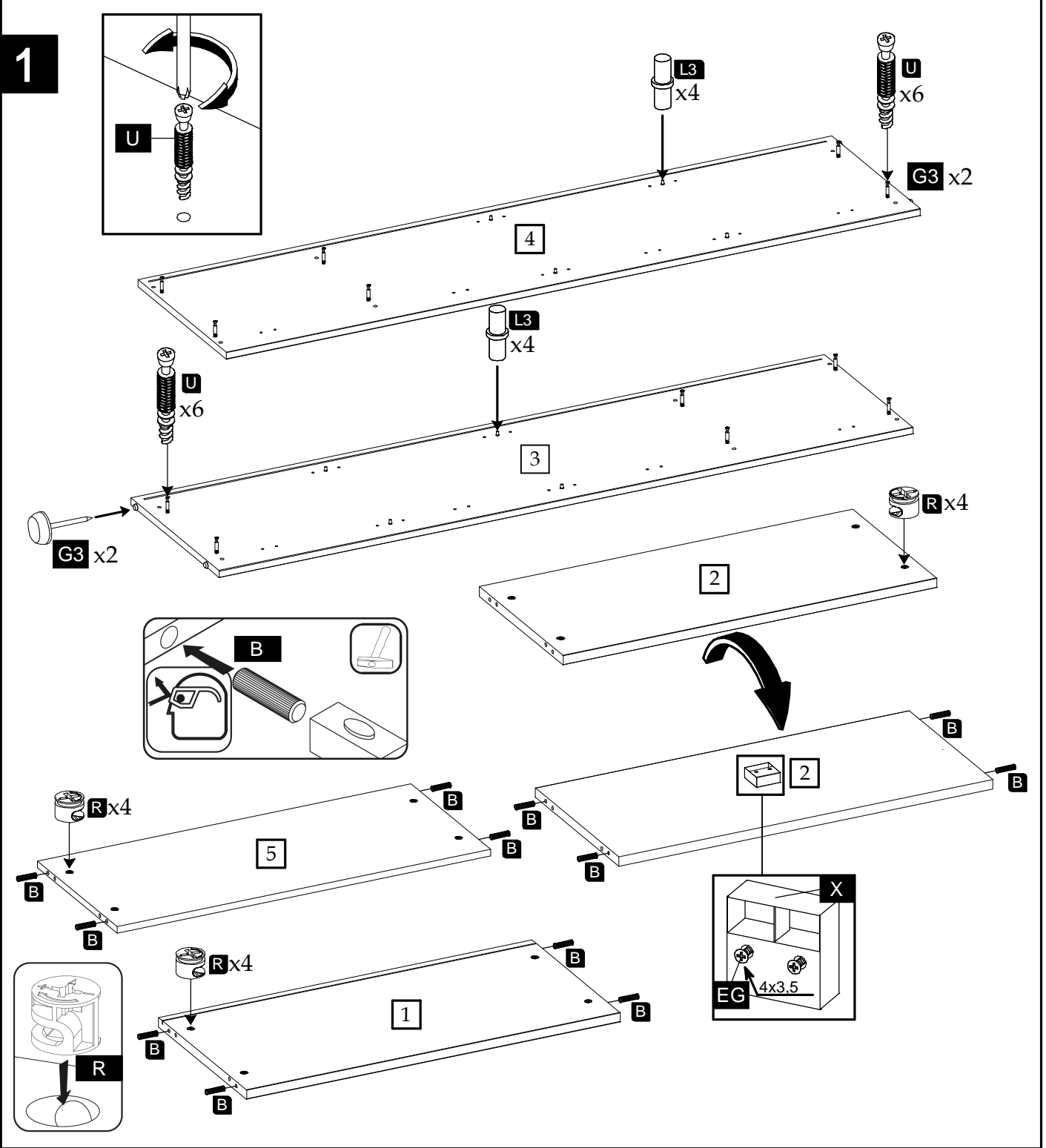
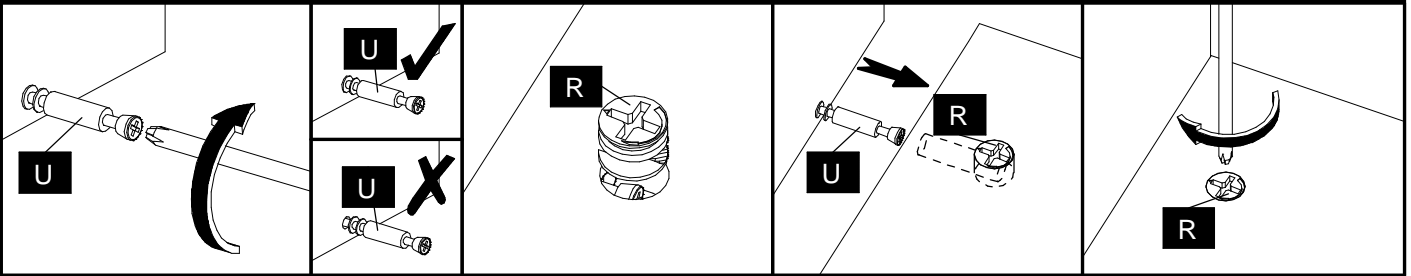

2

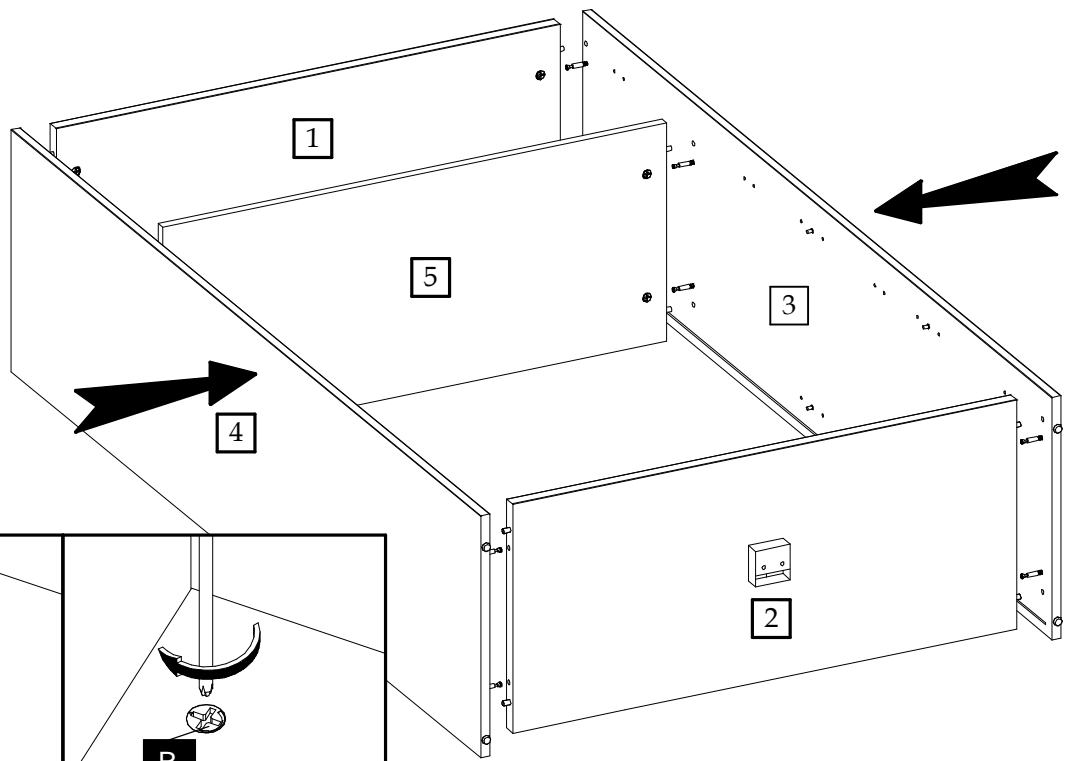

3

