

Adam

Typ P2

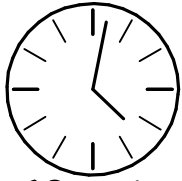

60 min

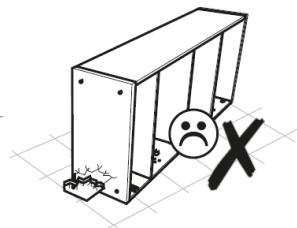
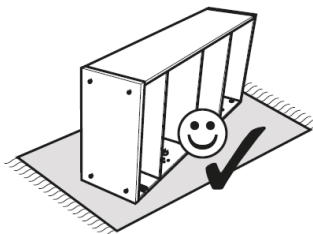
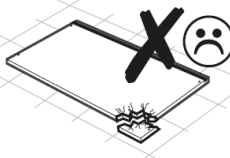
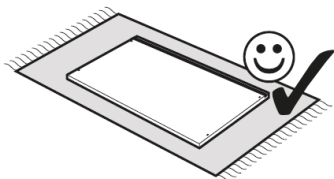
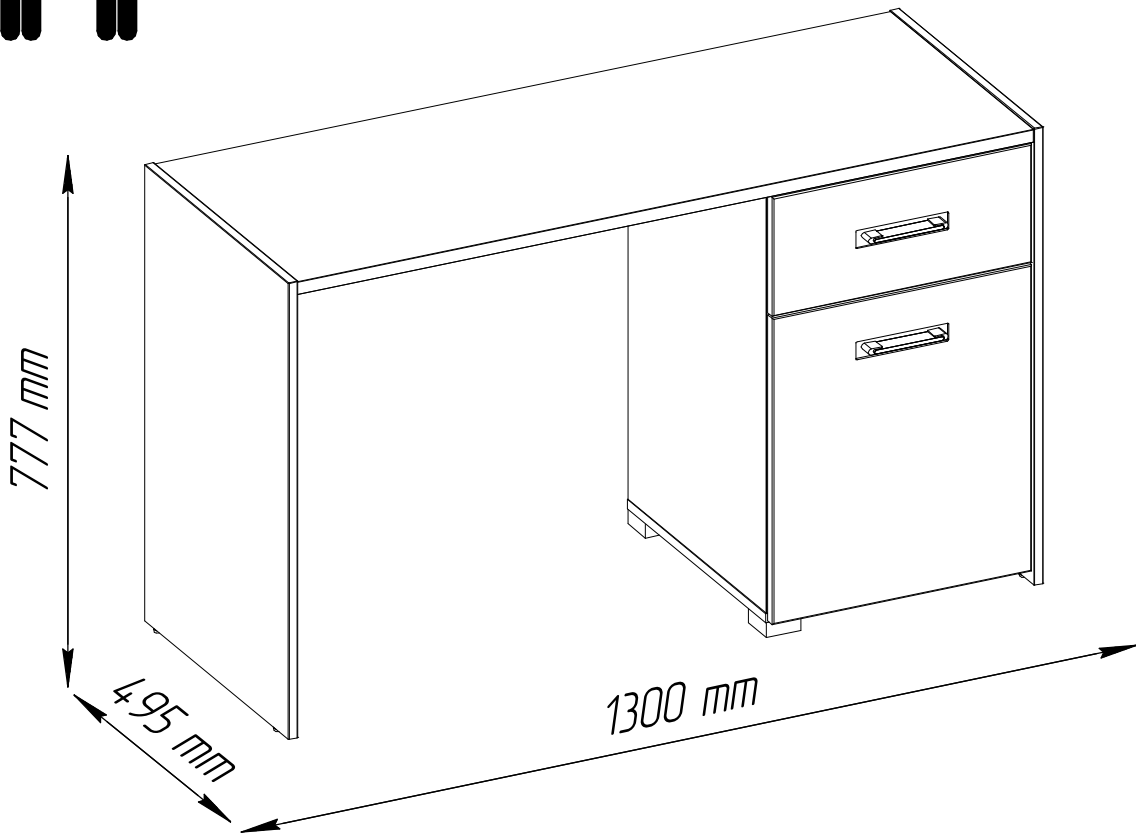
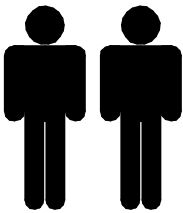

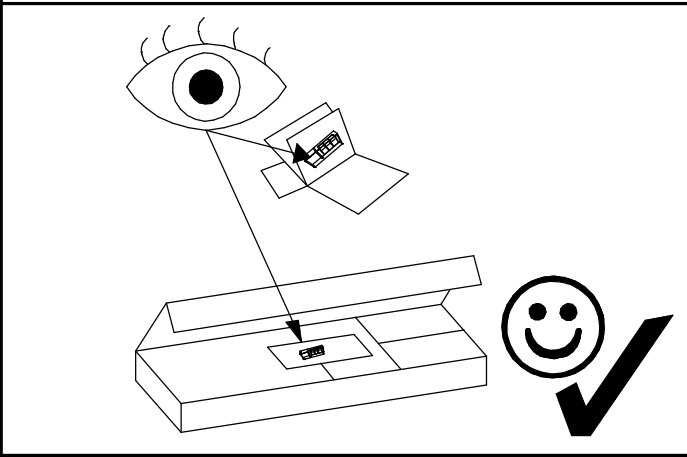

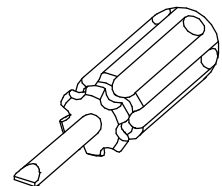
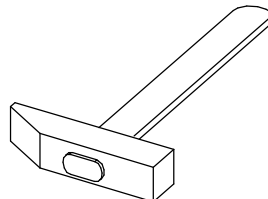
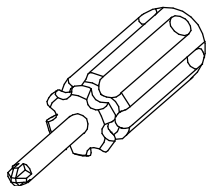
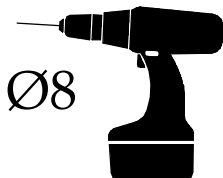
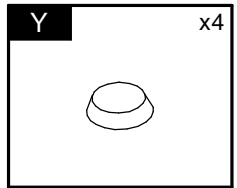
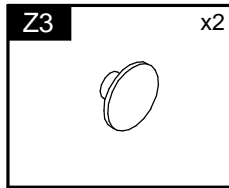
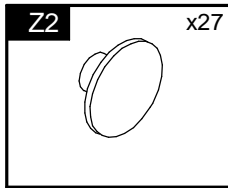
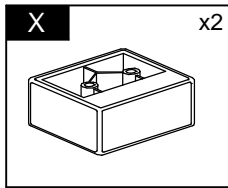
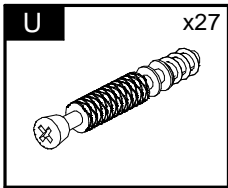
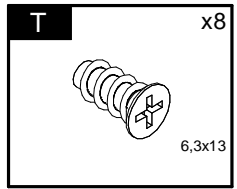
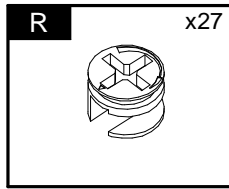
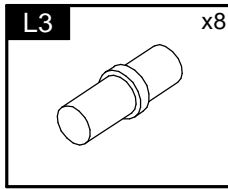
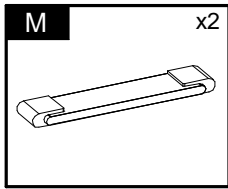
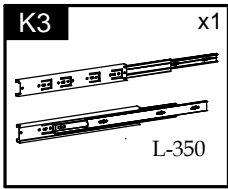
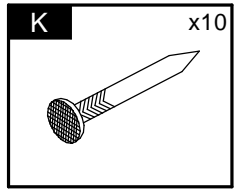
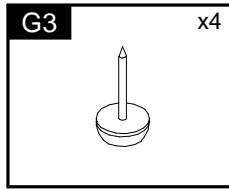
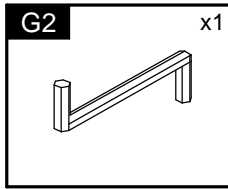
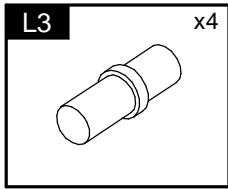
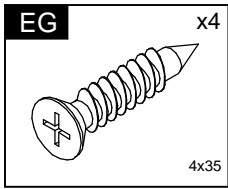
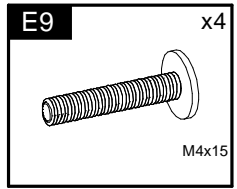
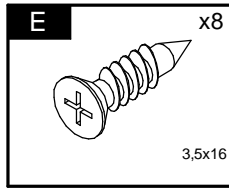
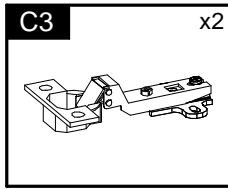
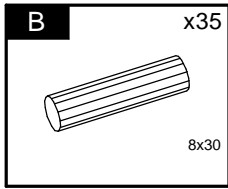
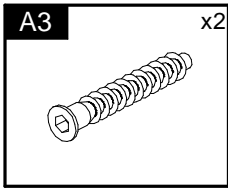
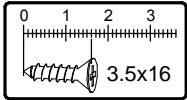

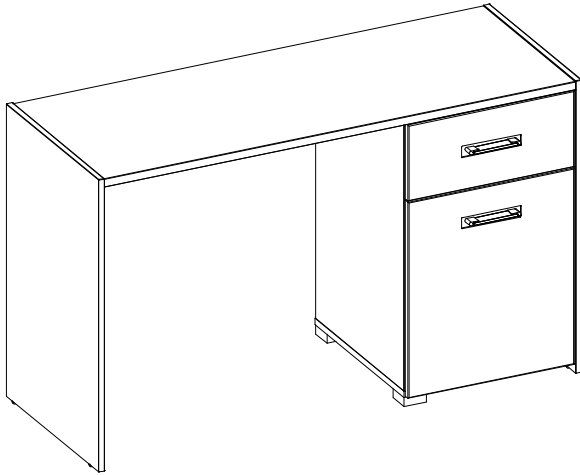

Element symbol	Measurements				Code	Paket
1	1268	492	22	1	1003	1/2
2	772	495	16	1	1002	1/2
3	772	495	16	1	1038	1/2
4	816	190	16	1	1028	1/2
5	711	475	16	1	1017/2017	1/2
6	711	436	16	1	1047	1/2
7	453	476	16	1	1048/2048	1/2
8	436	448	16	1	N/A	1/2
9	350.5	120	16	1	1043/2043	1/2
10	378.5	101.5	16	1	1044	1/2
11	350.5	120	16	1	1045/2045	1/2
12	388.5	355	3	1	N/A	2/2
13	520	449	16	1	1020/3001	2/2
14	449	203	16	1	1019/3002	2/2

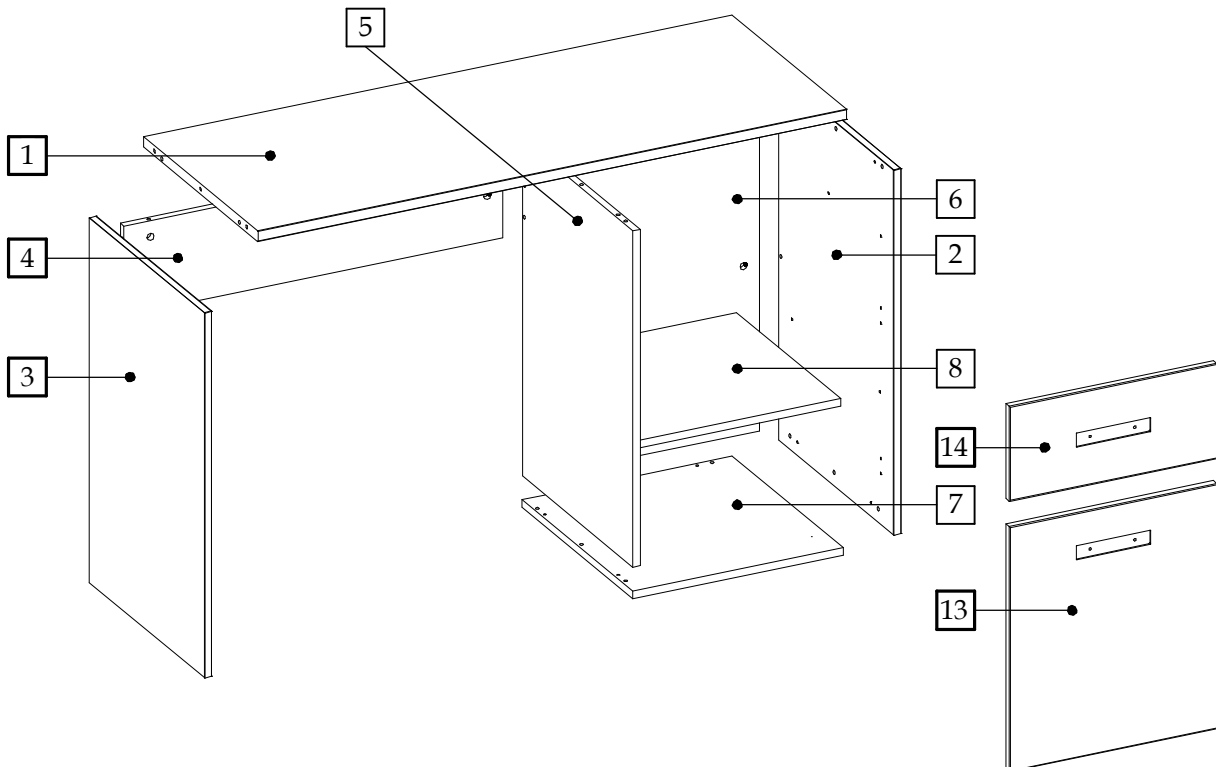
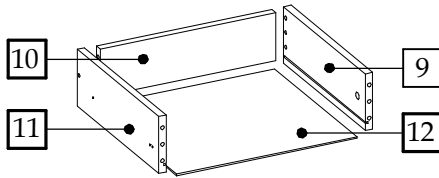



1

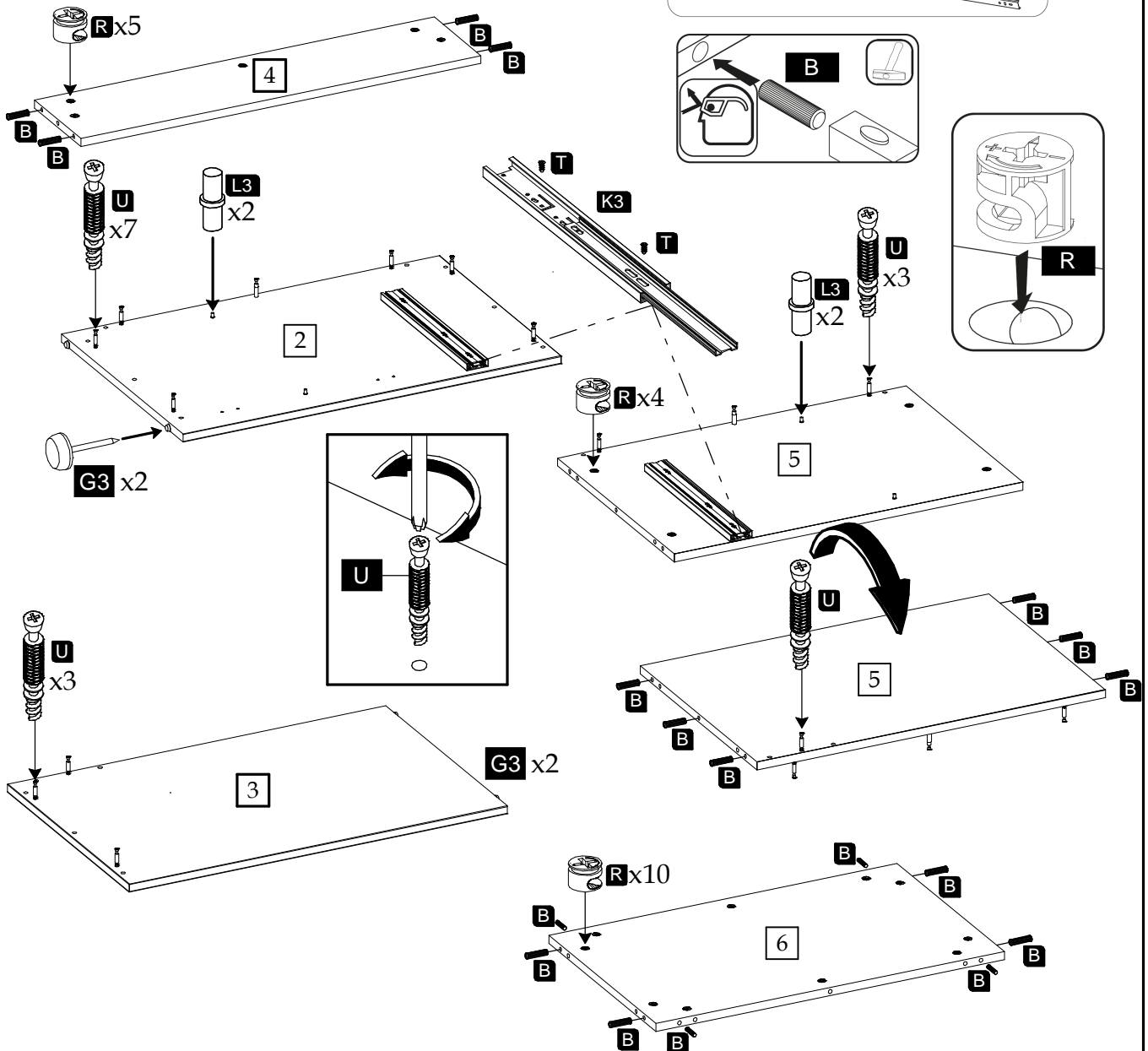
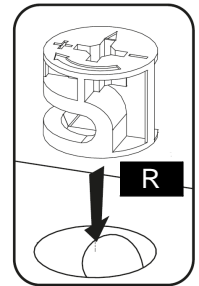
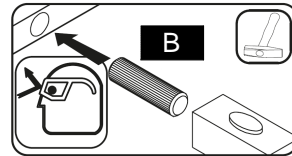
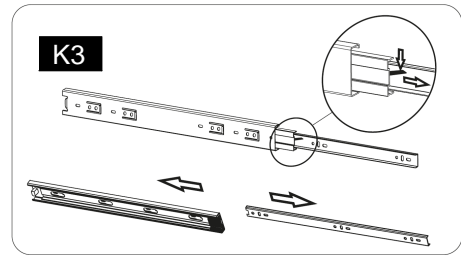
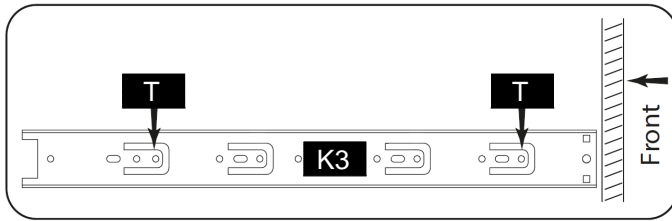

2

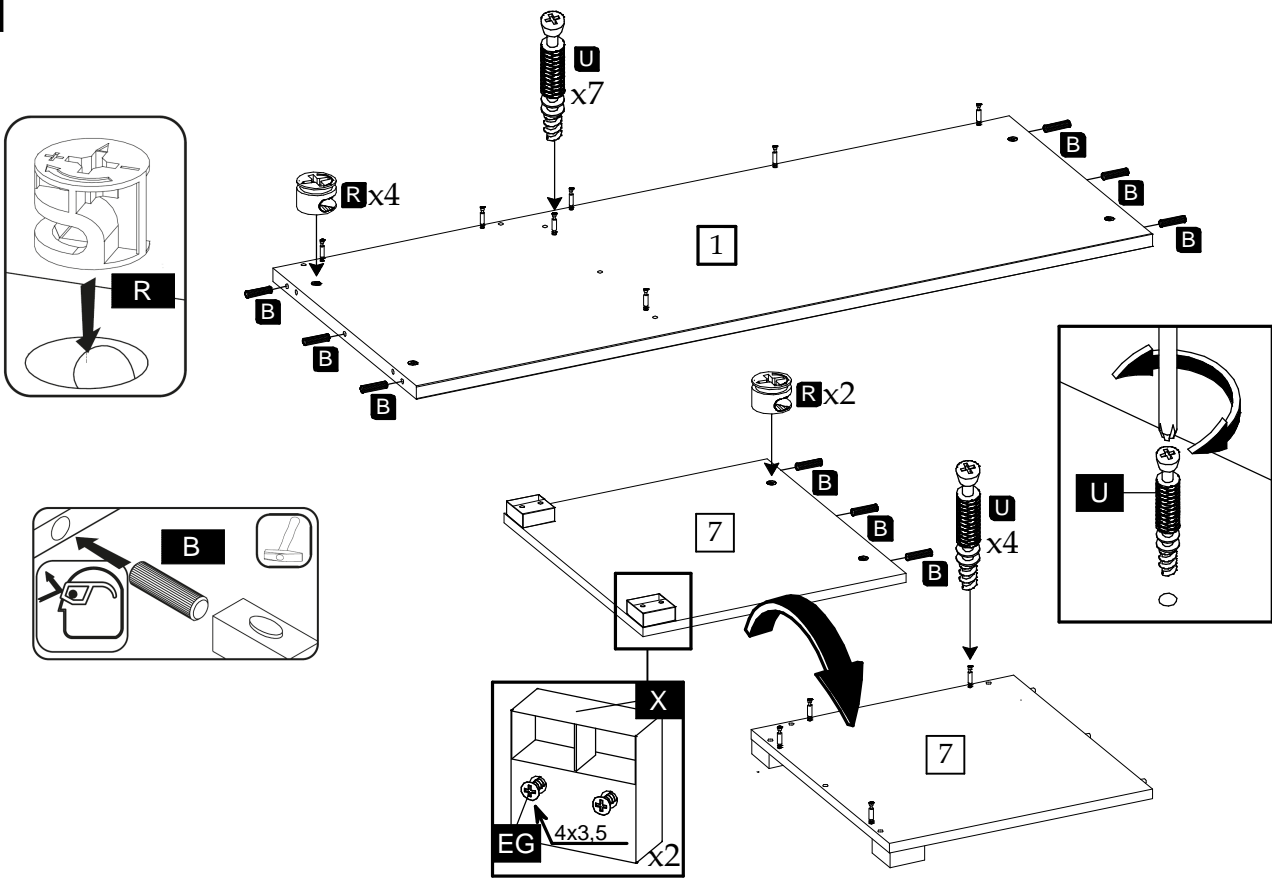

3

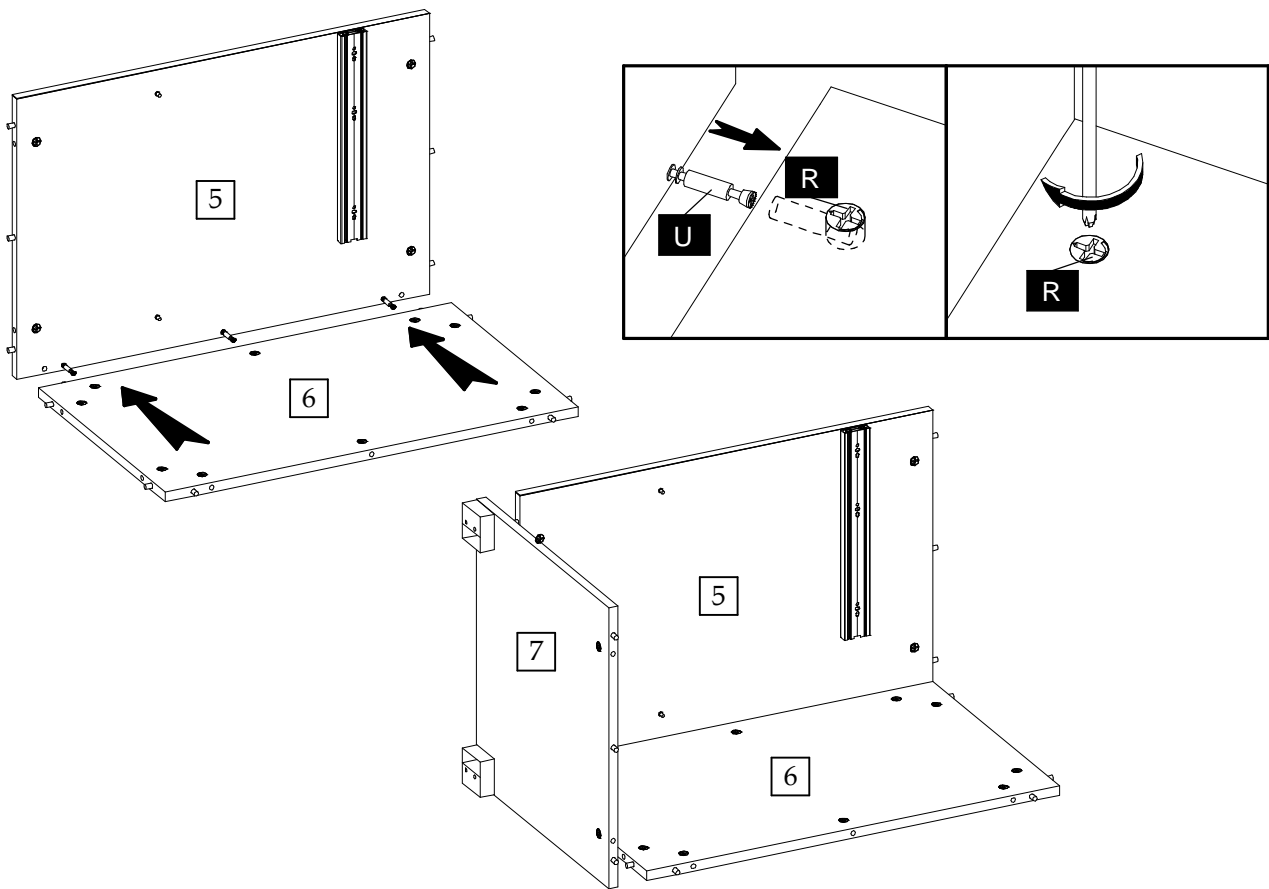

4

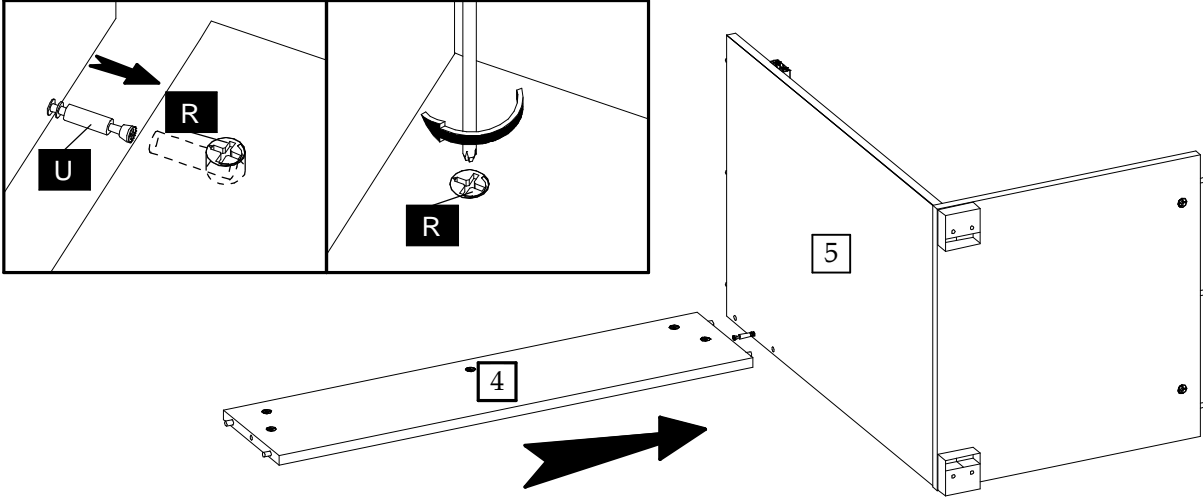

5

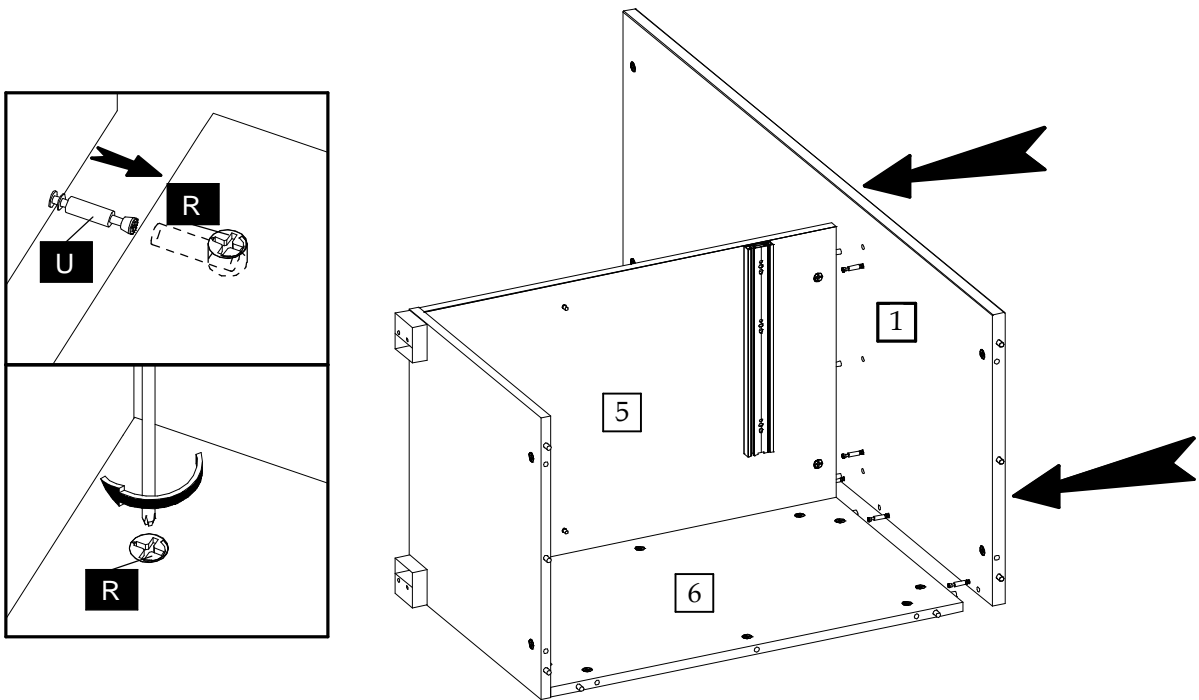

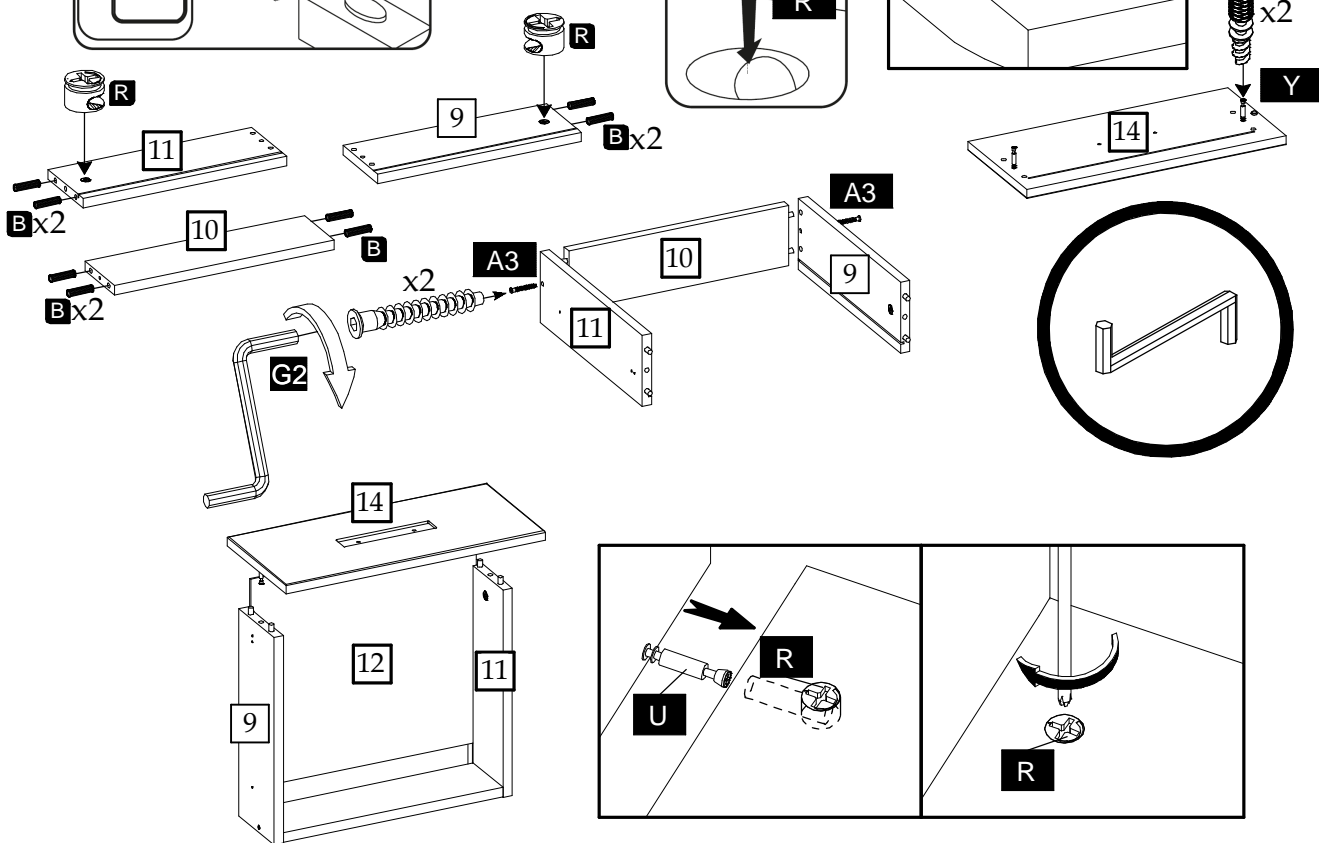
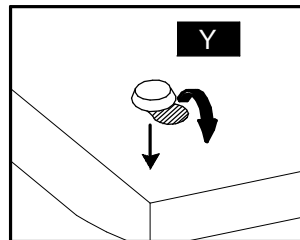
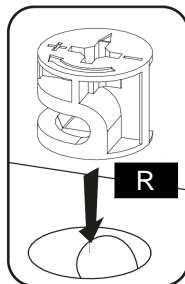
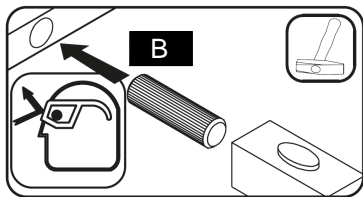
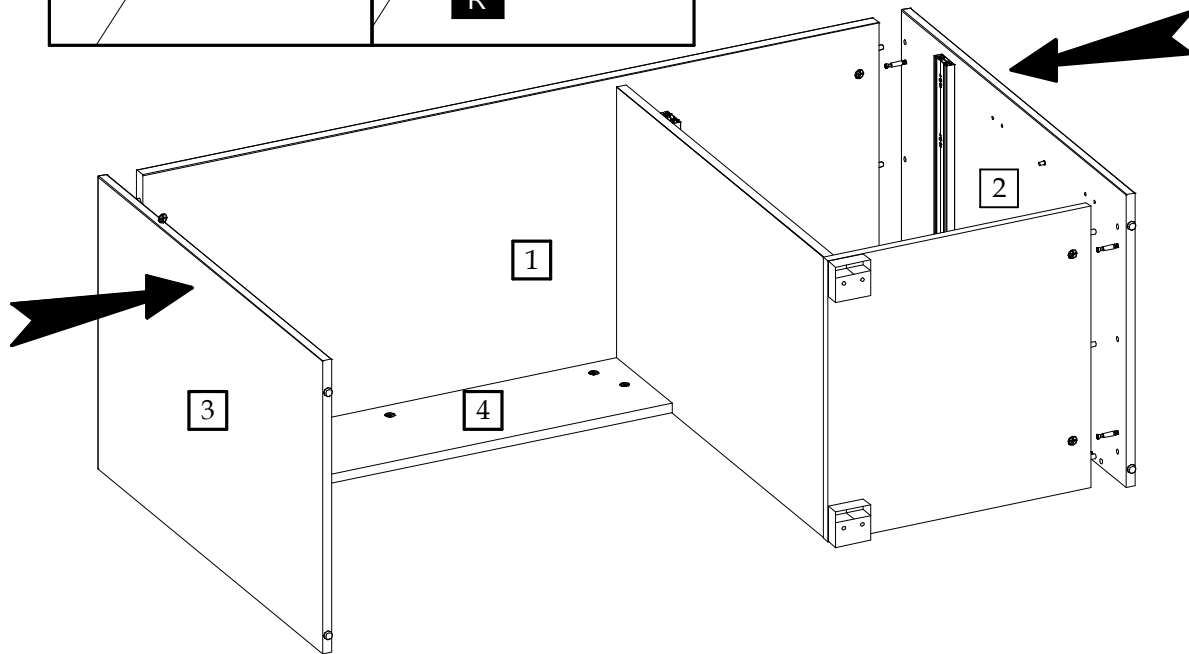
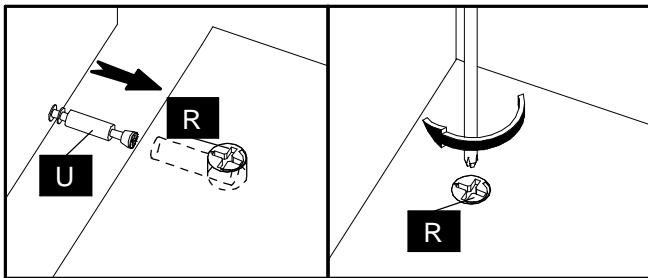

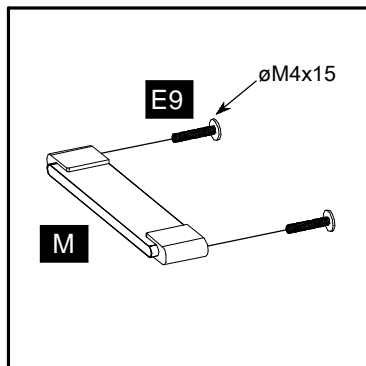
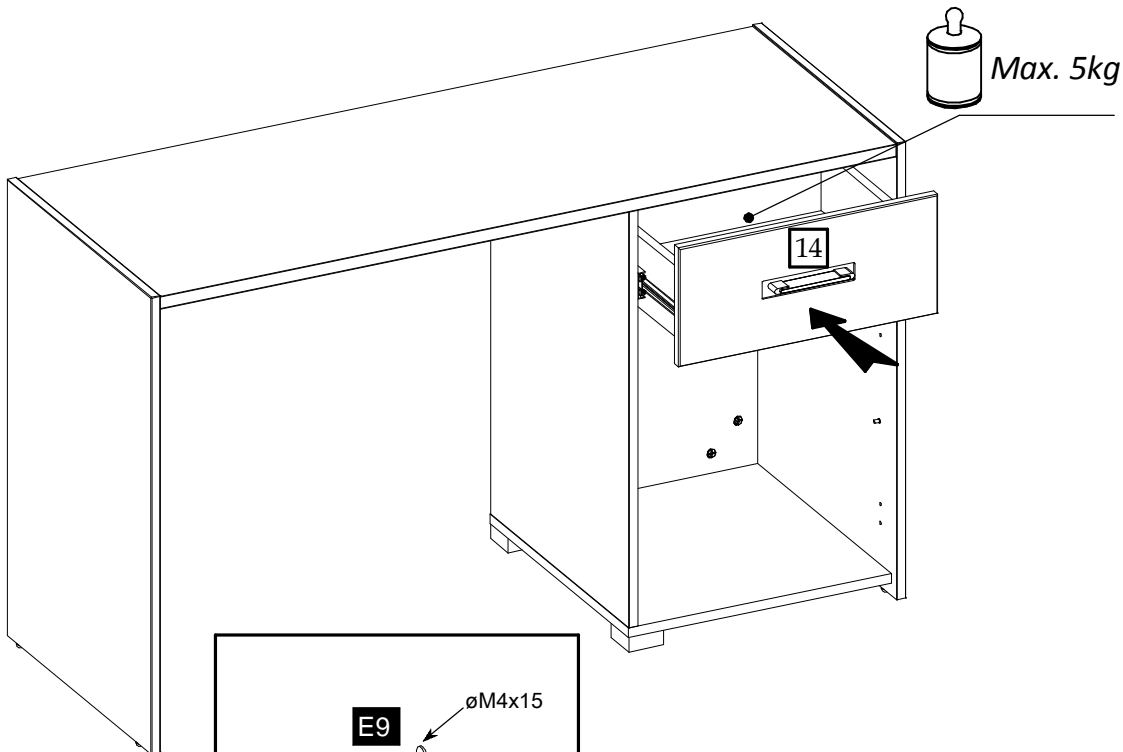
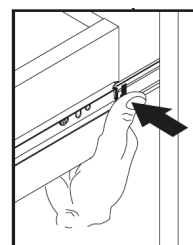
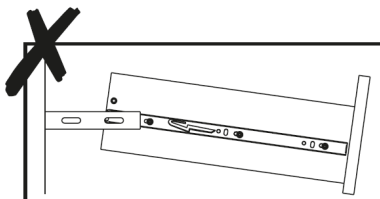
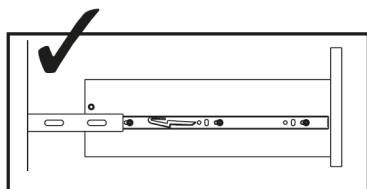
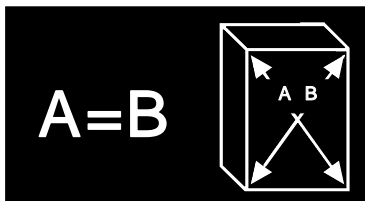
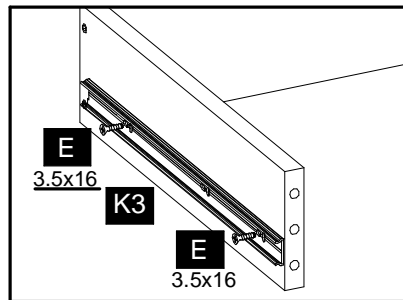
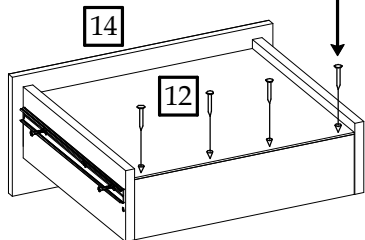
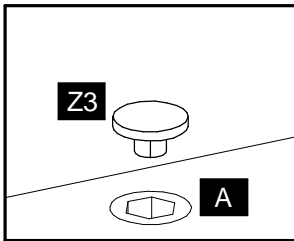

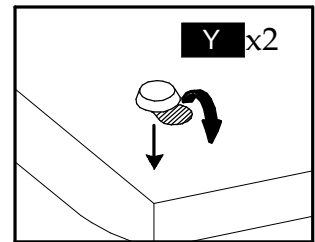
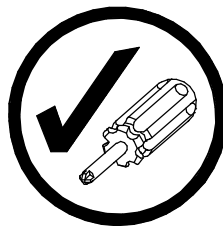
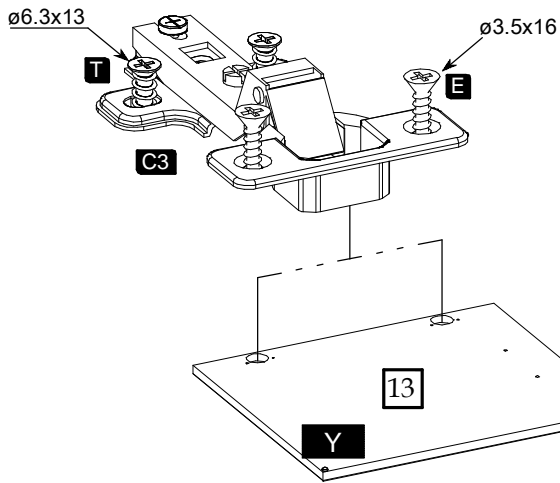

Max. 30kg

