

Adam

Typ V

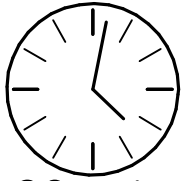

90 min

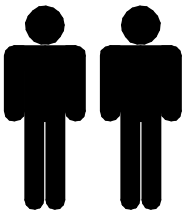

2025 mm

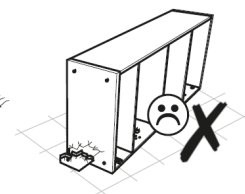
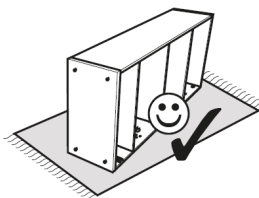
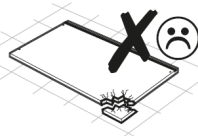
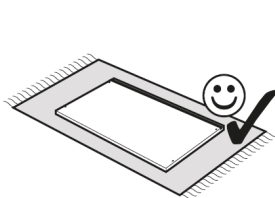
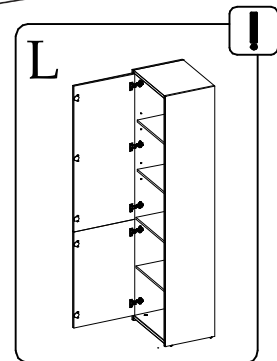
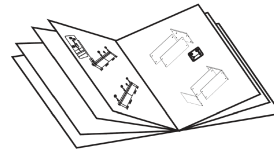
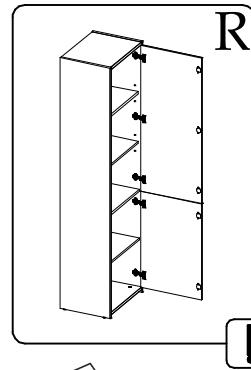
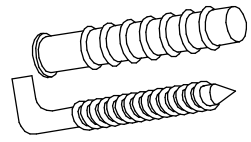
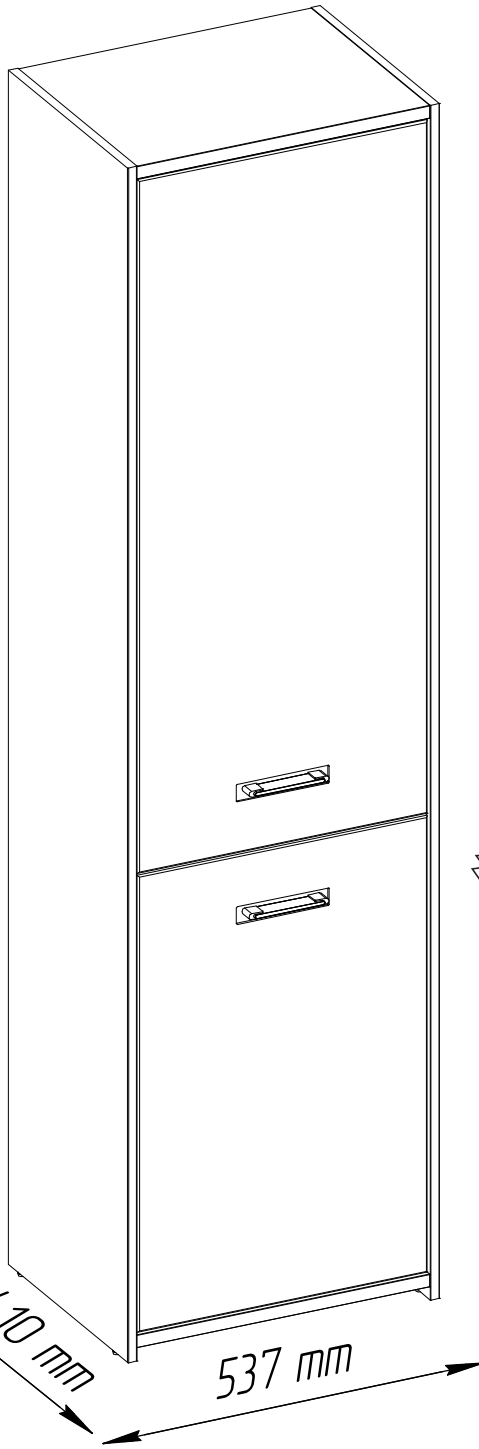

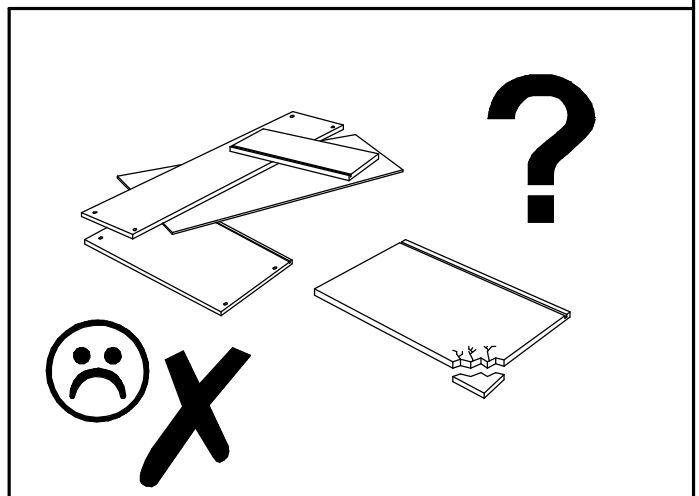
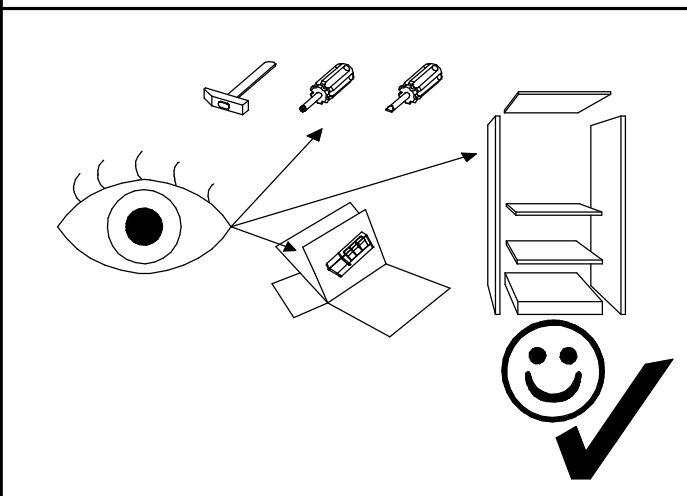
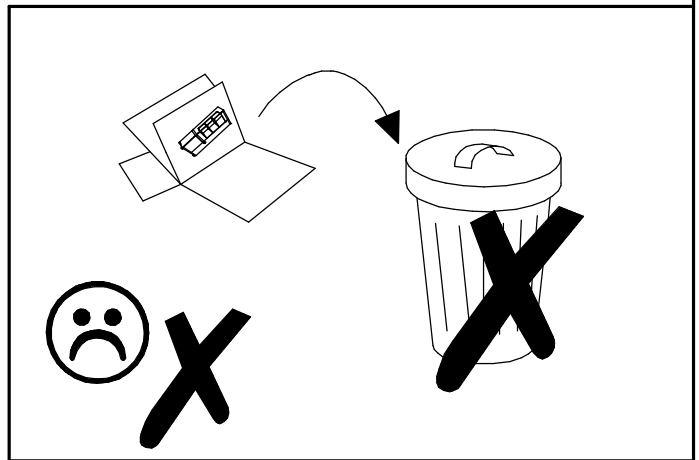
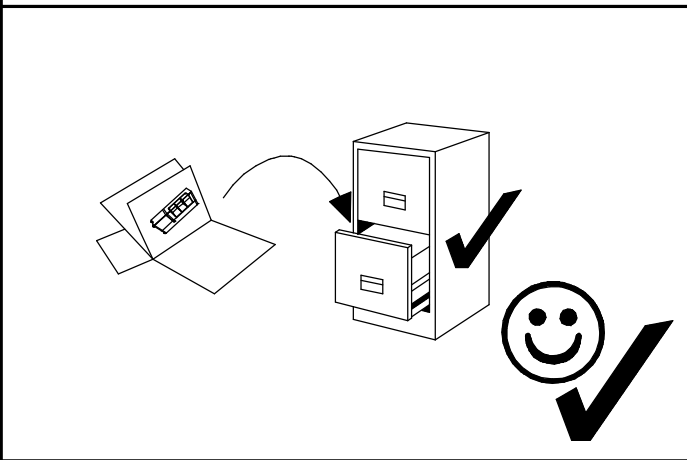
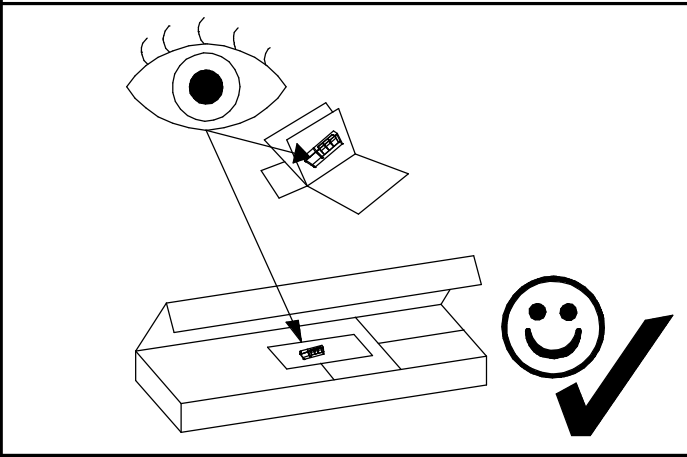

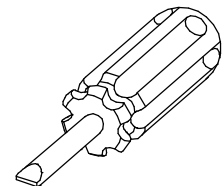
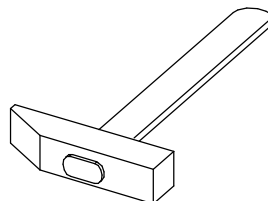
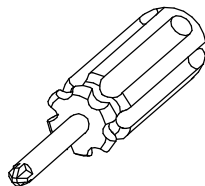
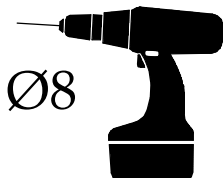
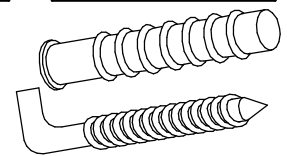
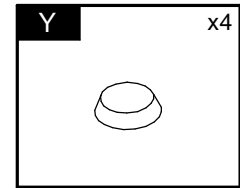
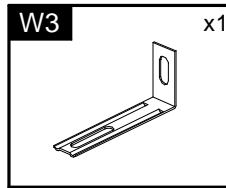
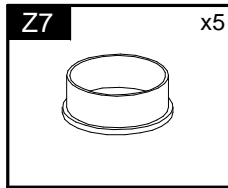
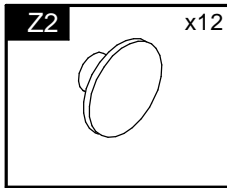
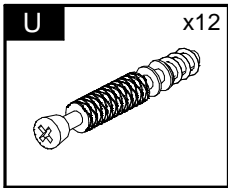
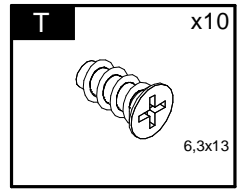
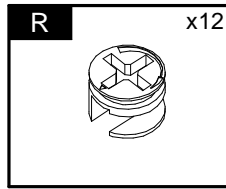
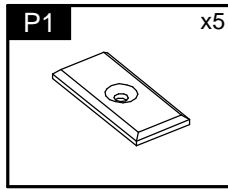
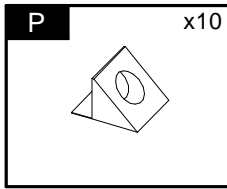
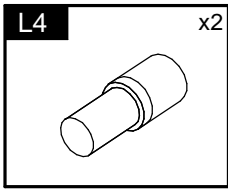
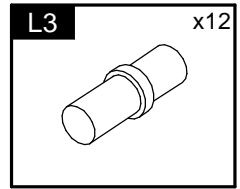
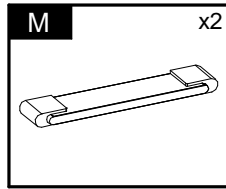
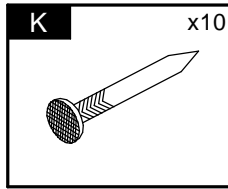
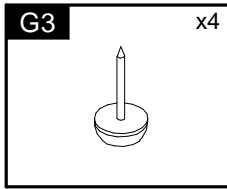
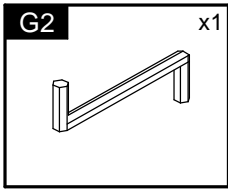
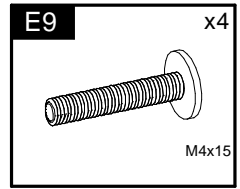
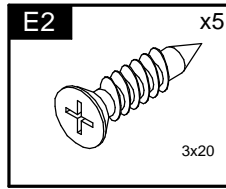
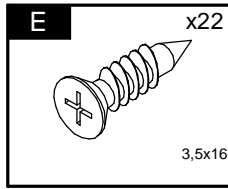
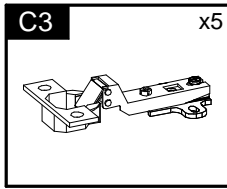
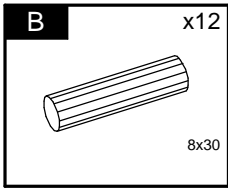
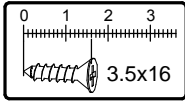
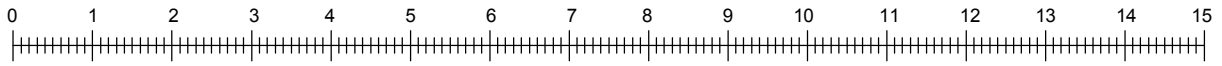

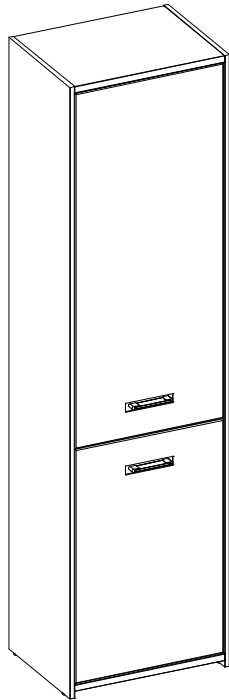

Element symbol	Measurements				Code	Paket
1	505	407.5	22	1	1005	1/2
2	505	387.5	22	1	1004	1/2
3	2020	409.5	16	1	1002	1/2
4	2020	409.5	16	1	1003	1/2
5	505	369.5	16	1	1012	1/2
6	505	368.5	16	1	N/A	1/2
7	505	368.5	16	1	N/A	1/2
8	505	368.5	16	1	N/A	1/2
9	1184	259.5	3	2	N/A	1/2
10	798	519	3	1	N/A	2/2
11	1175	502	16	1	1017/3001	2/2
12	775	502	16	2	1016/3002	2/2

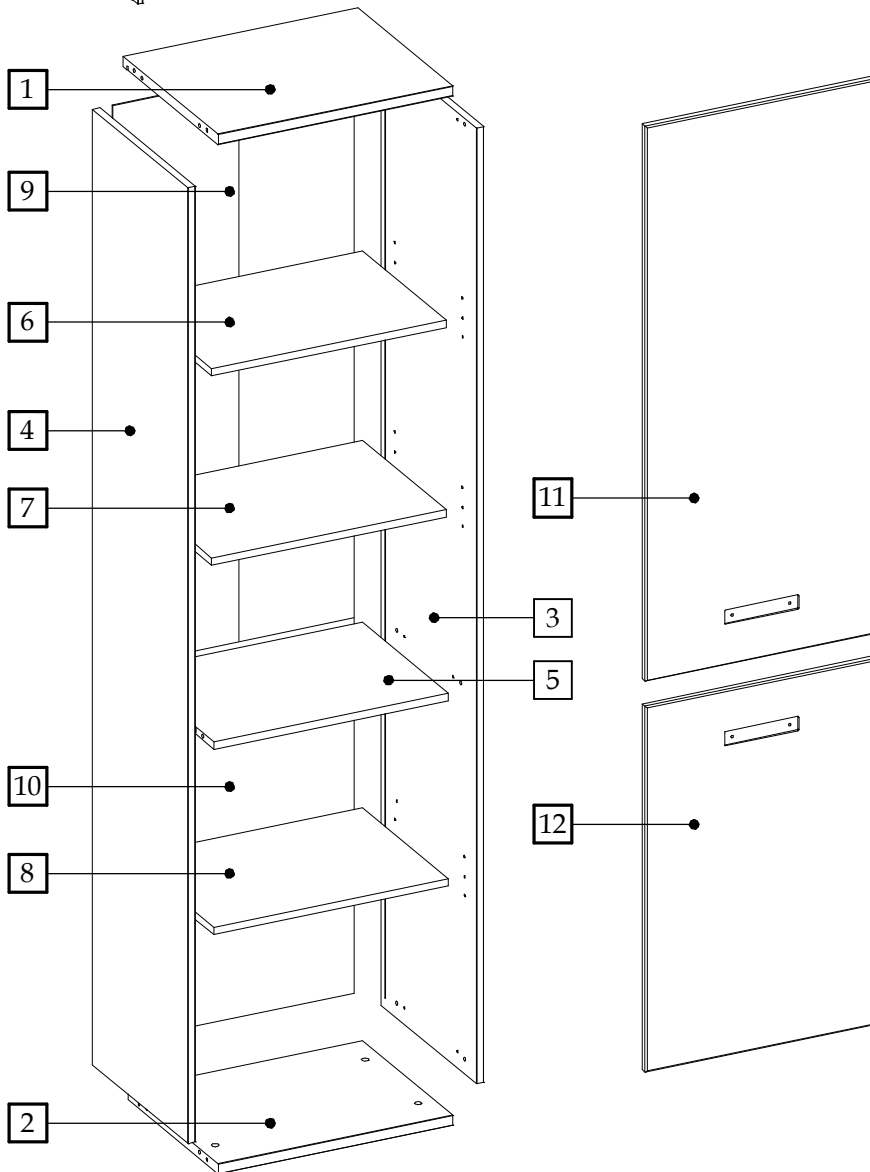

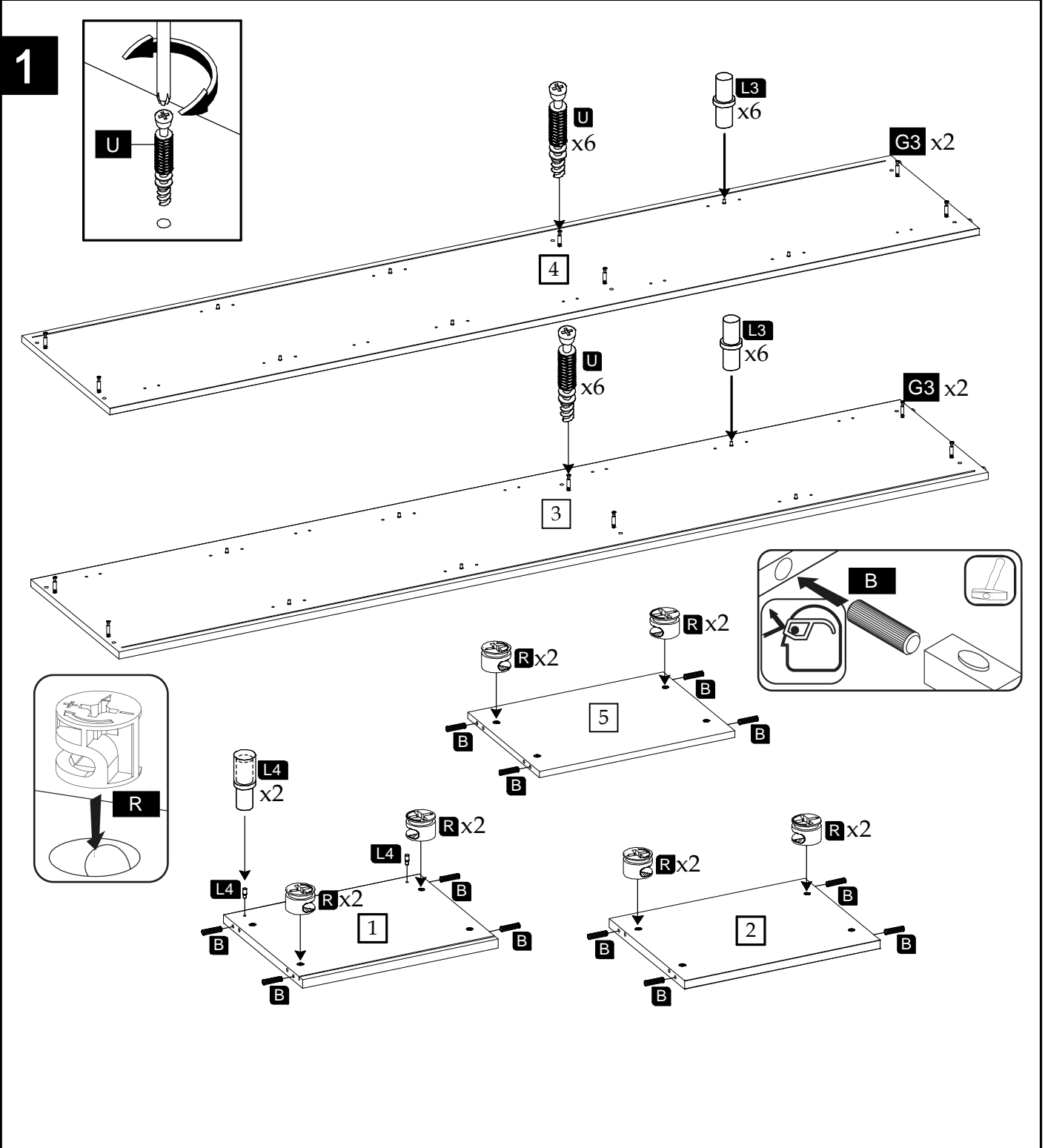
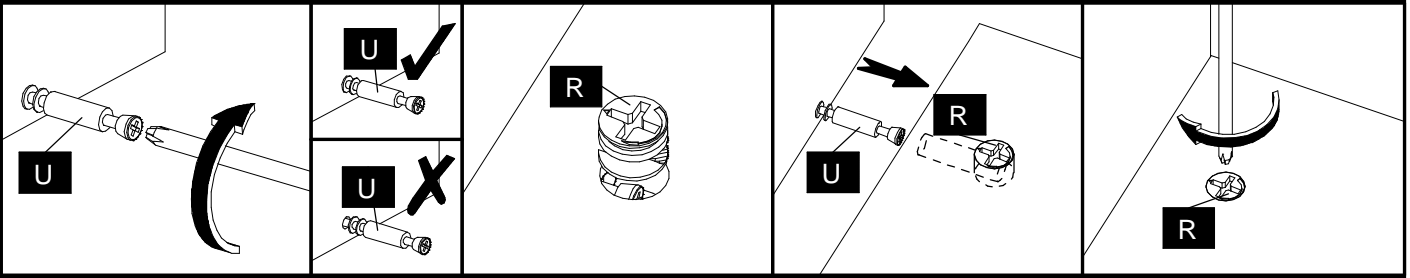

2

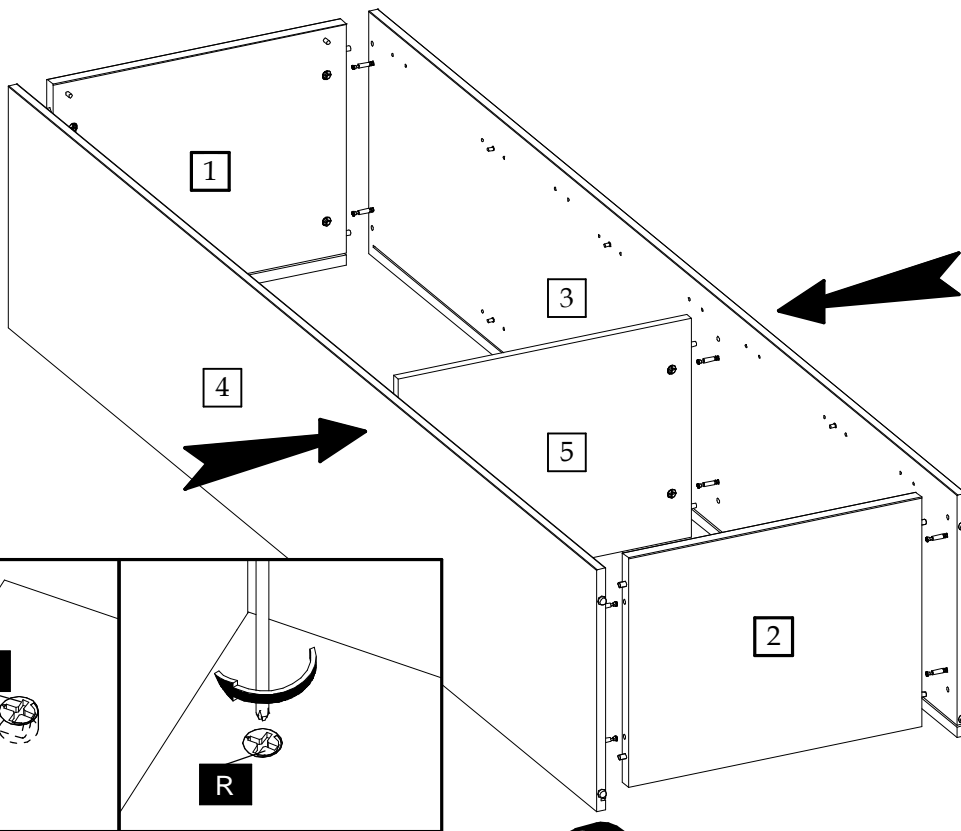

3

