

ARON T

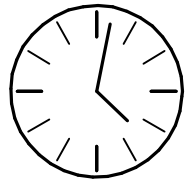

60 min

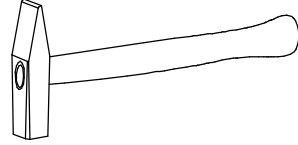

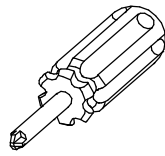
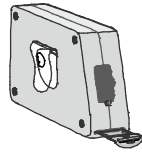
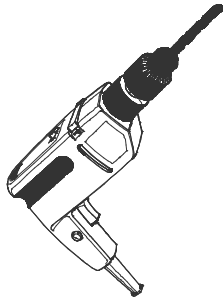
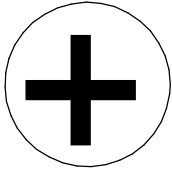
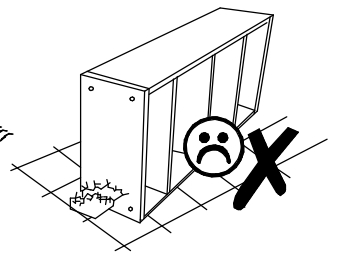
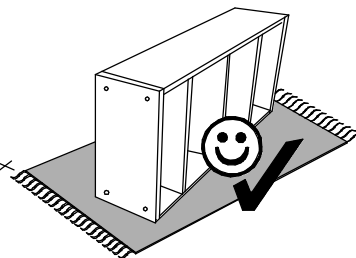
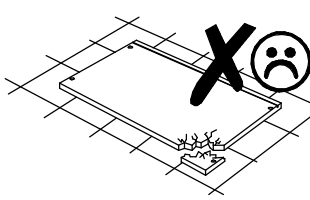
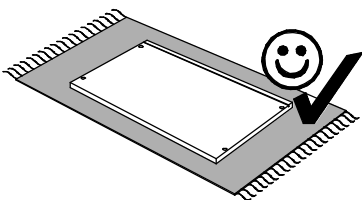
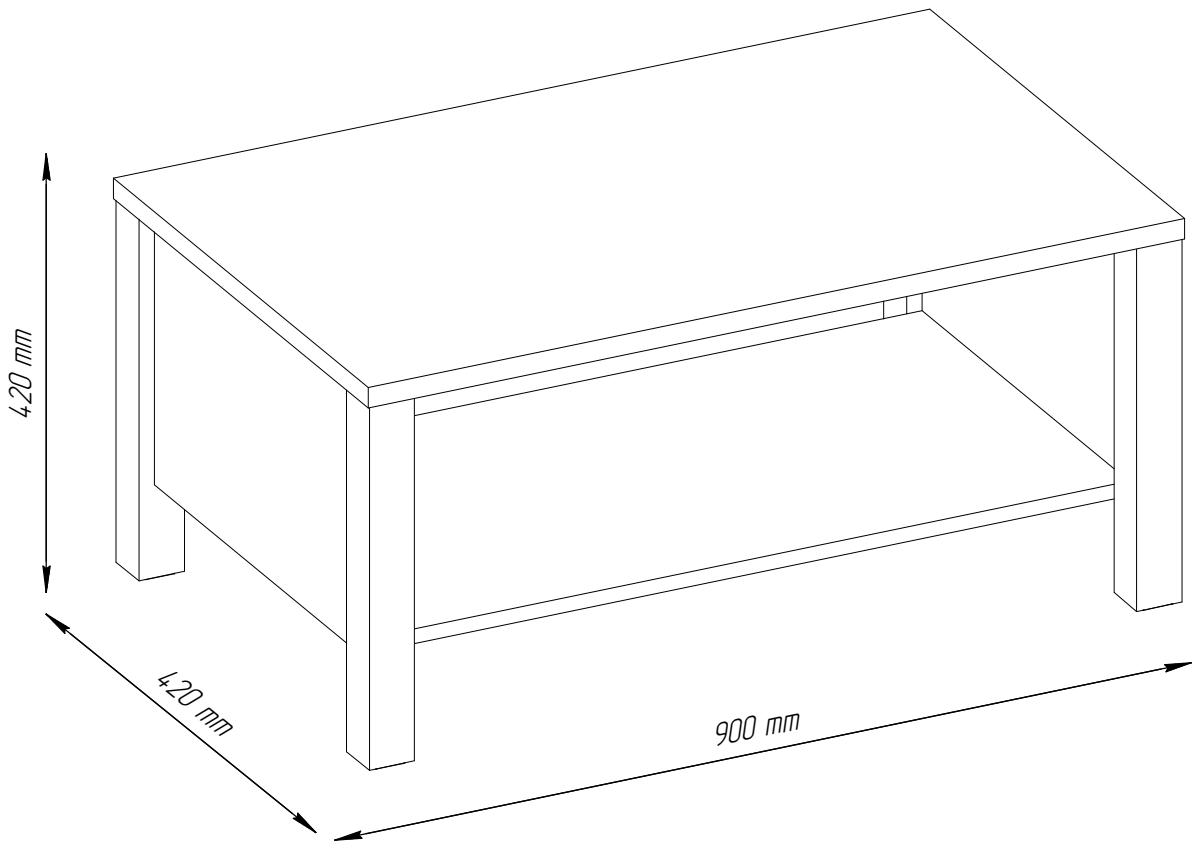
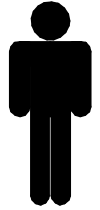
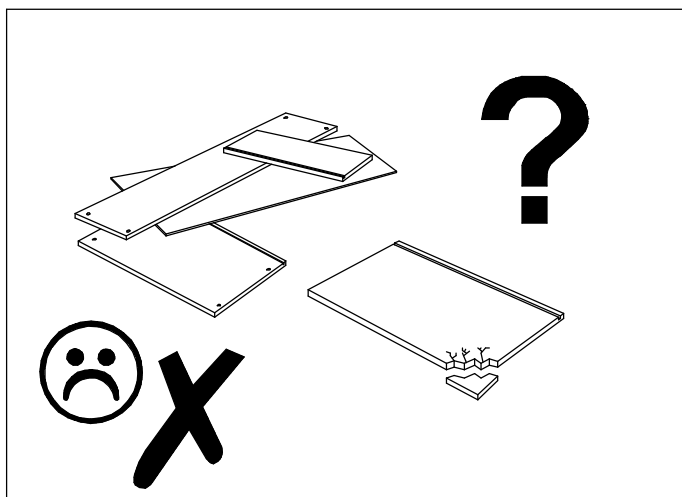
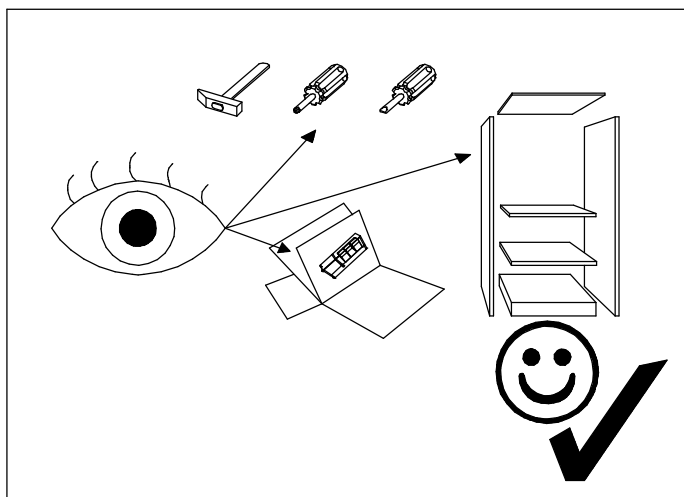
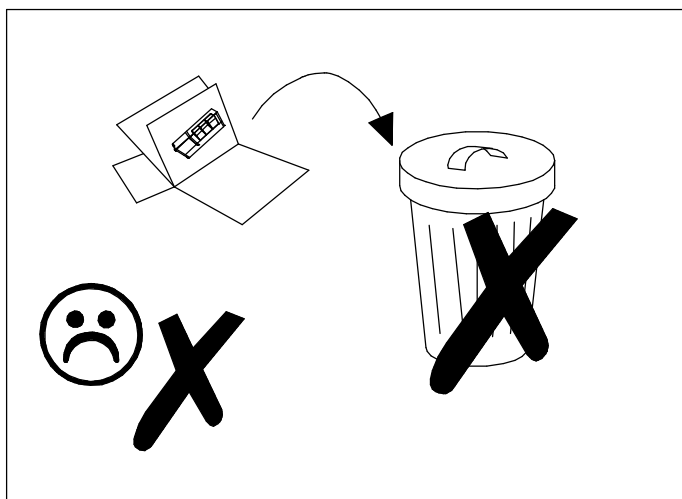
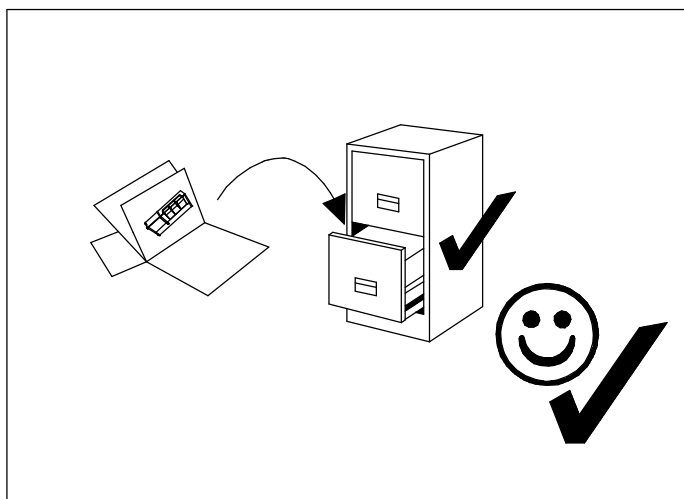
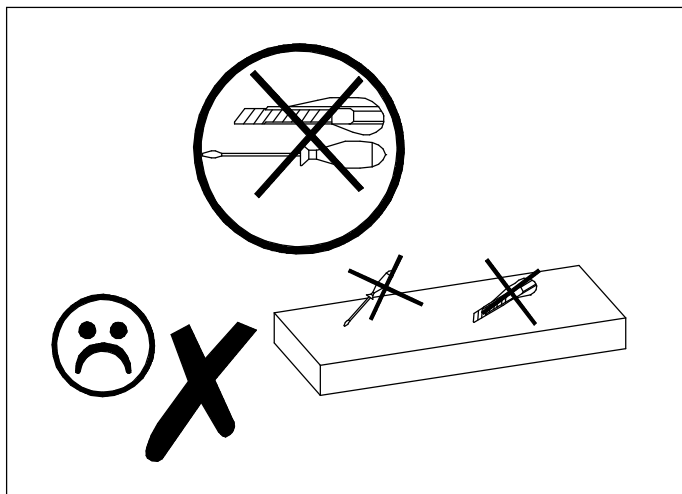
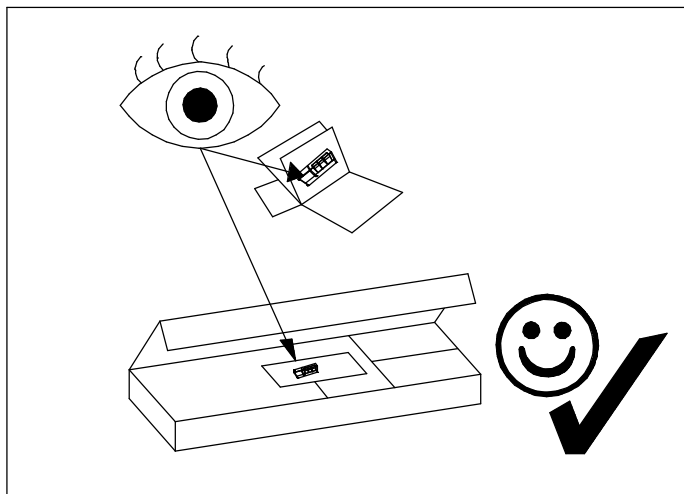

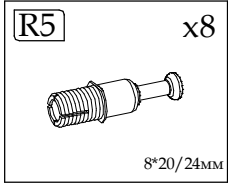
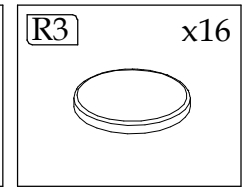
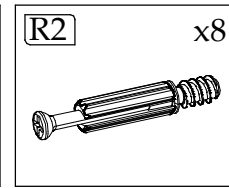
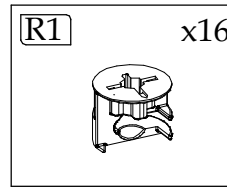
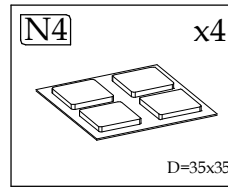
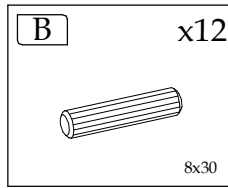
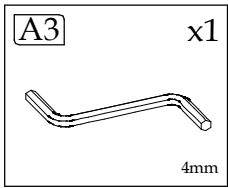

Element symbol	Measurements				Code	Pack
1	900	560	22	1	1002	1/1
2	456	293	16	2	1033-1035	1/1
3	830	454	16	1	1034	1/1
4	393	50	50	4	P50_393x50	1/1

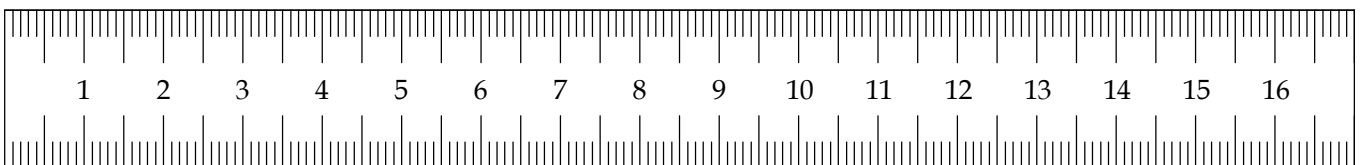
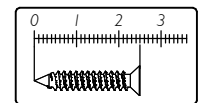
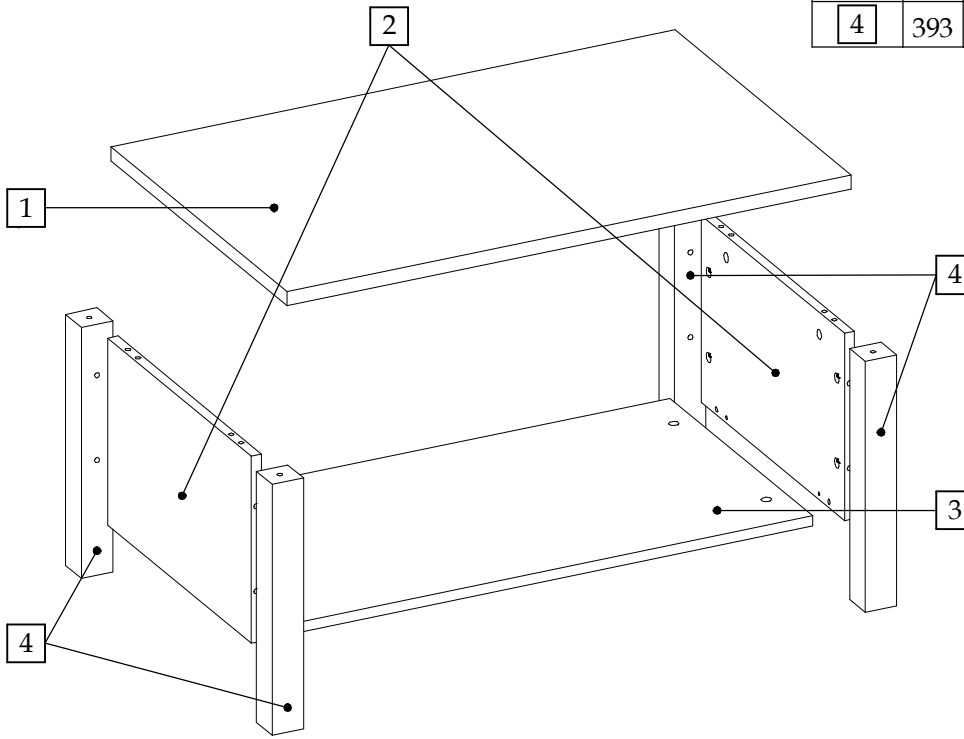

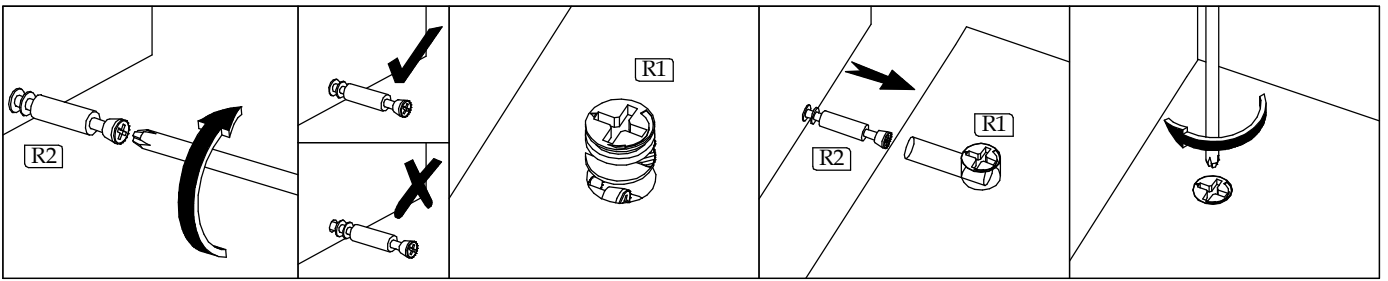

▶ 1

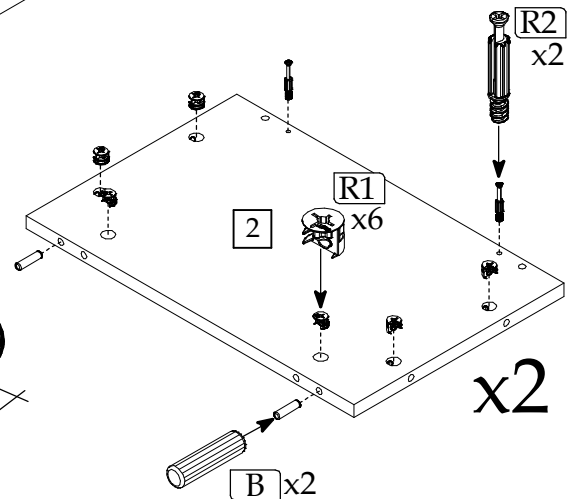
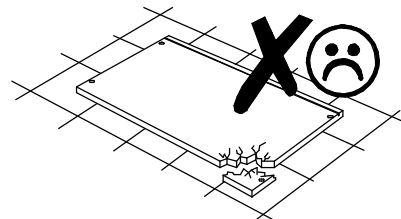
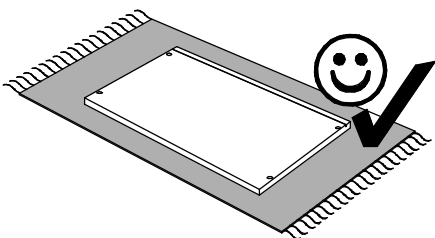
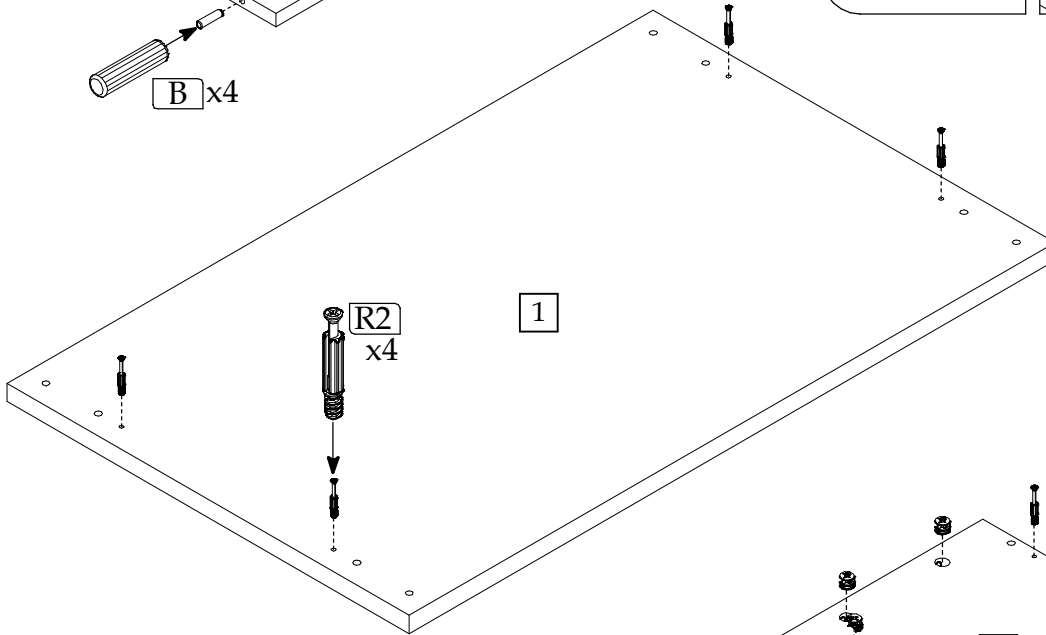
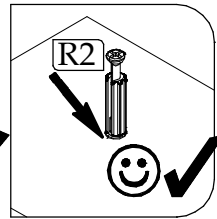
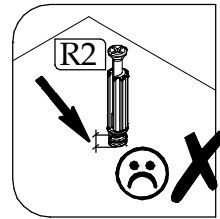
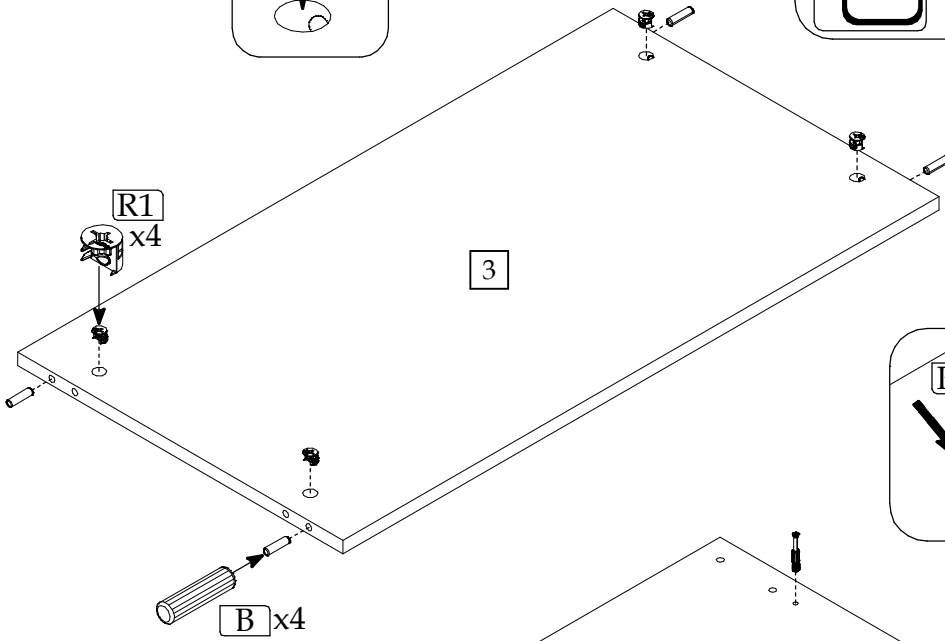
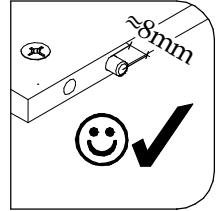
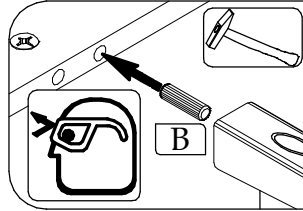
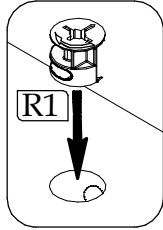

▶ 2

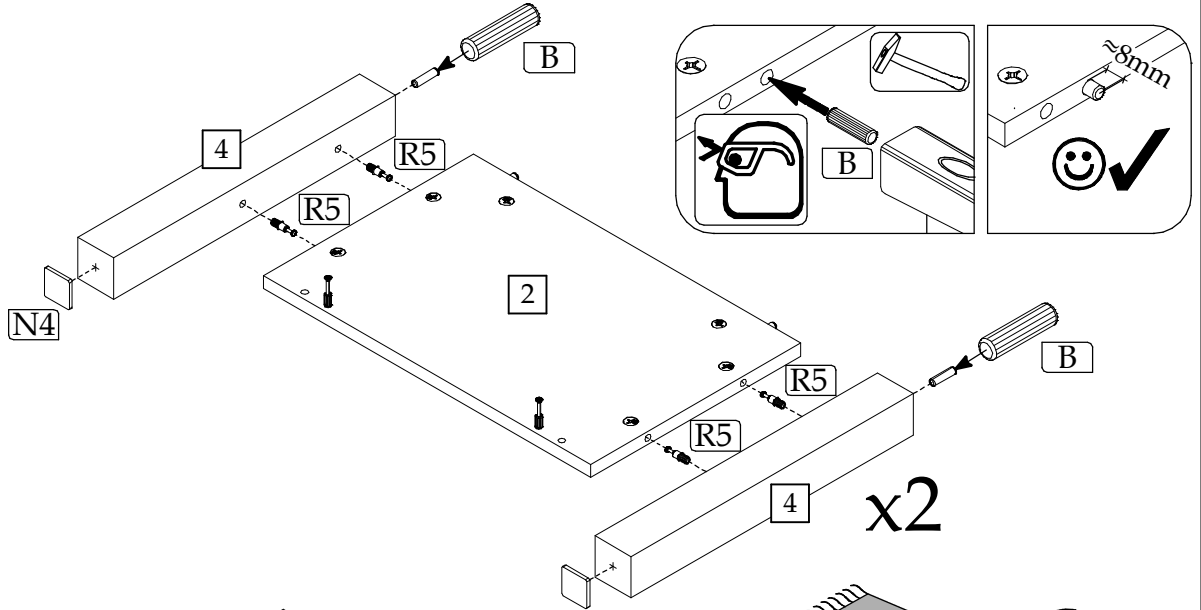
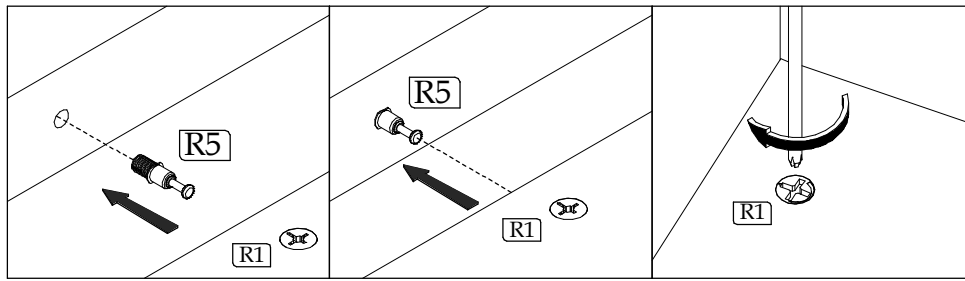

▶ 3

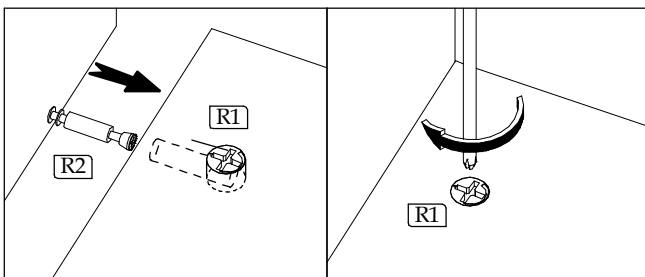
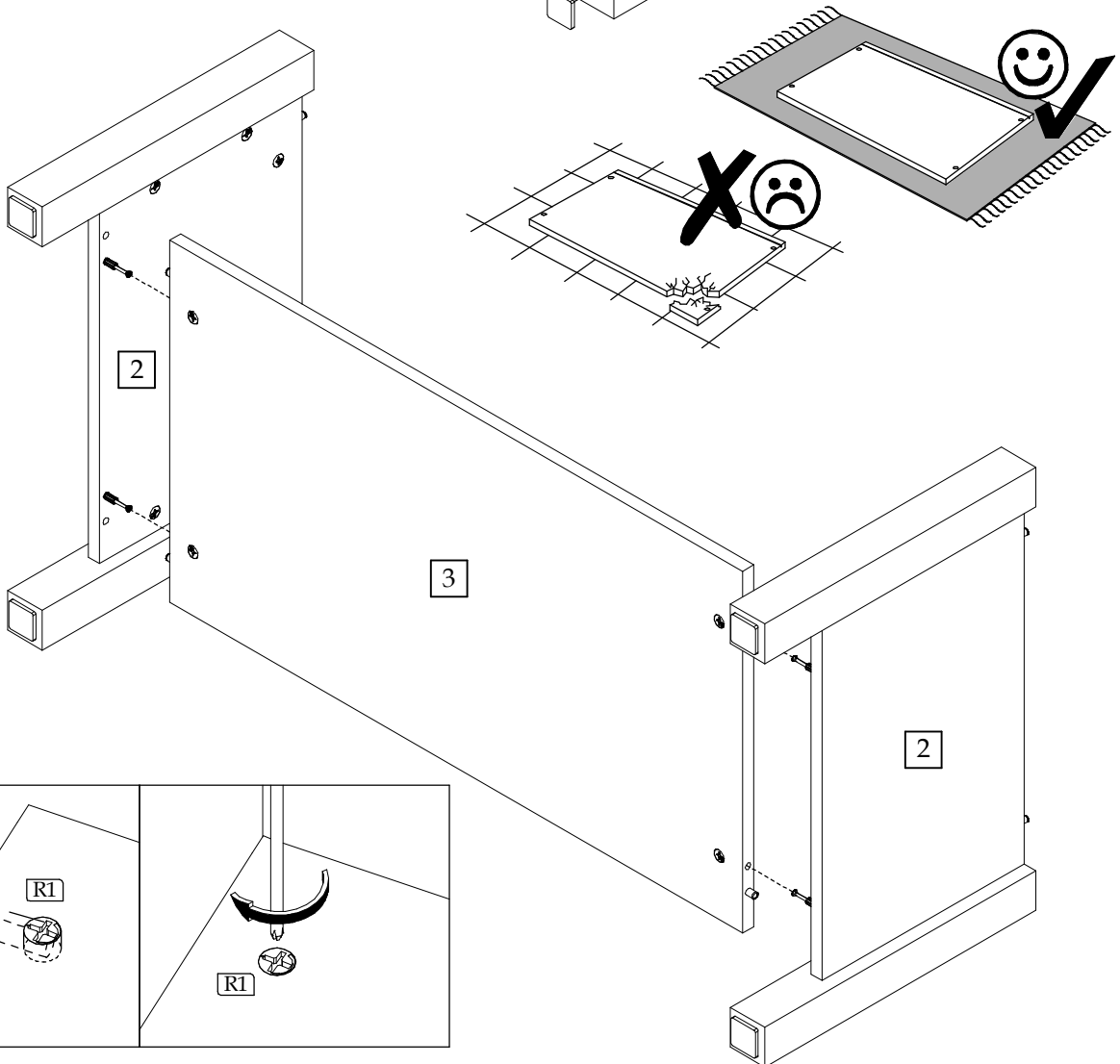

▶ 4

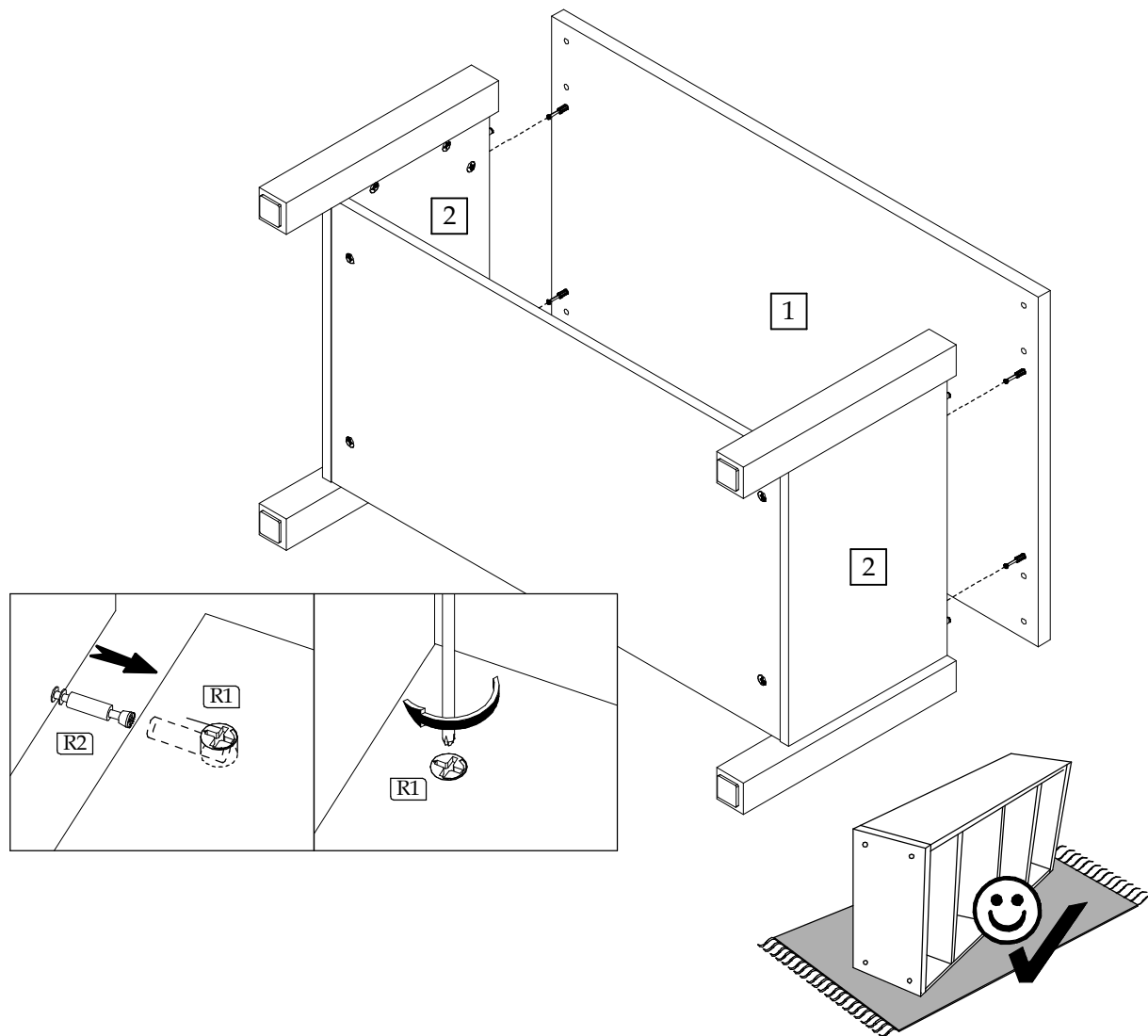

▶ 5

