

# CONCORD

## Typ C1

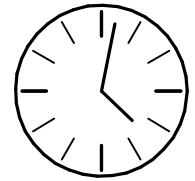

80 min

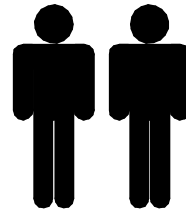
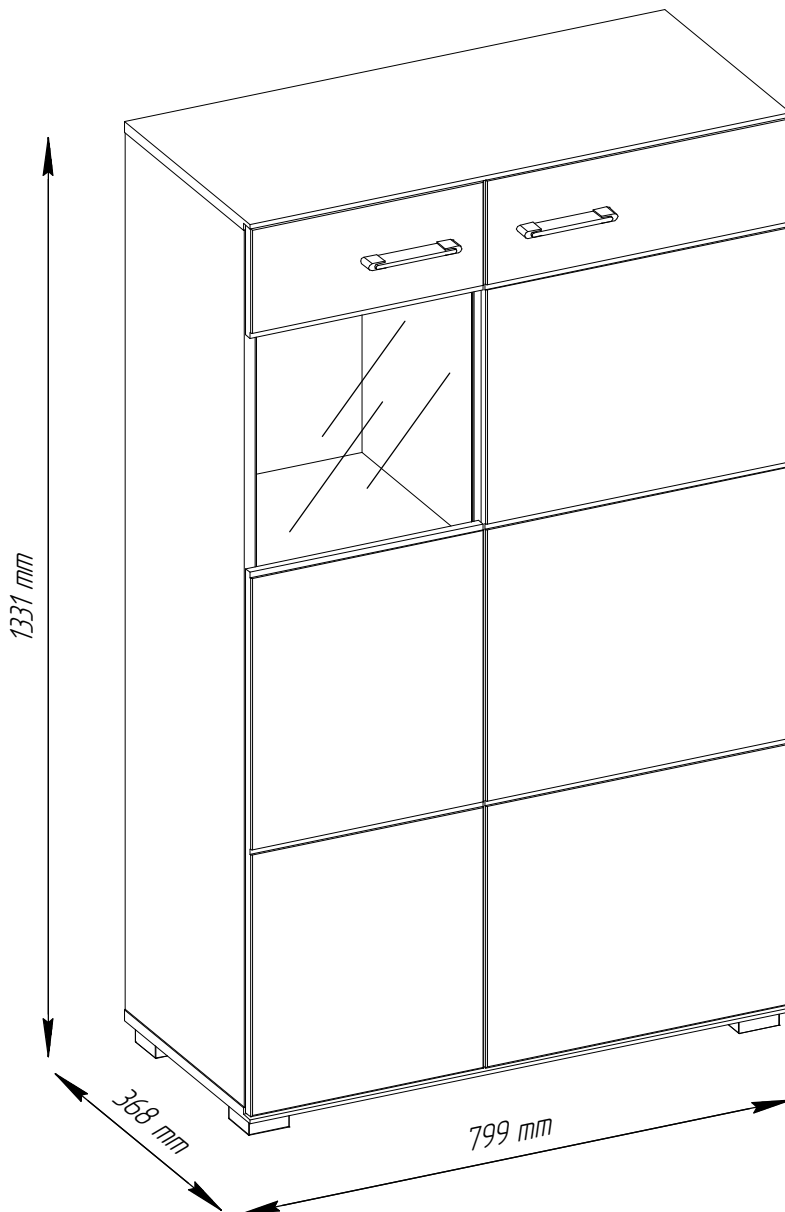

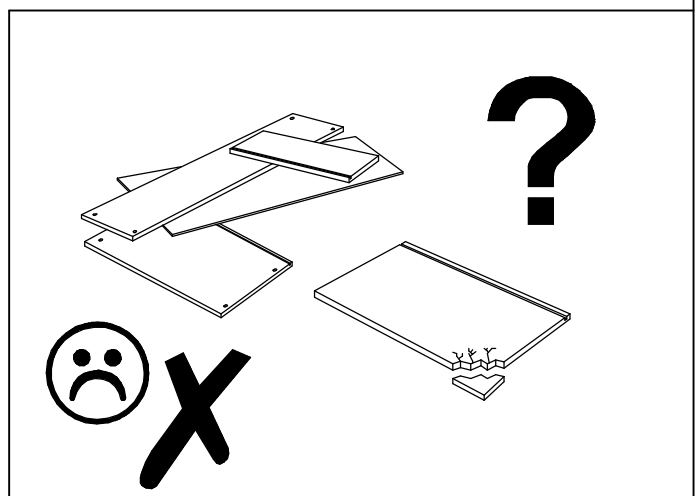
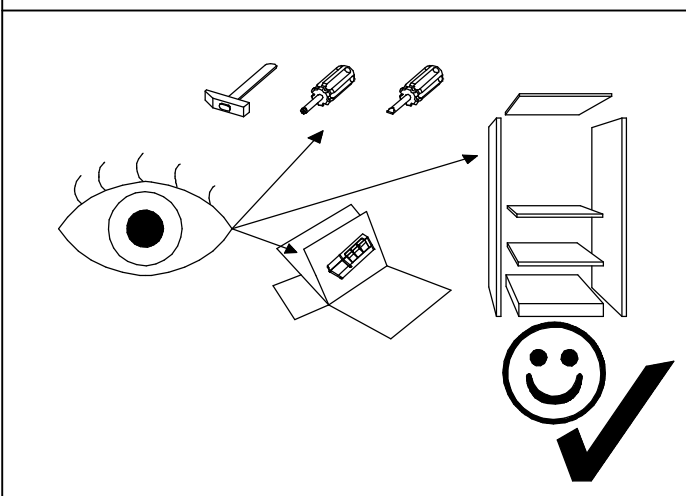
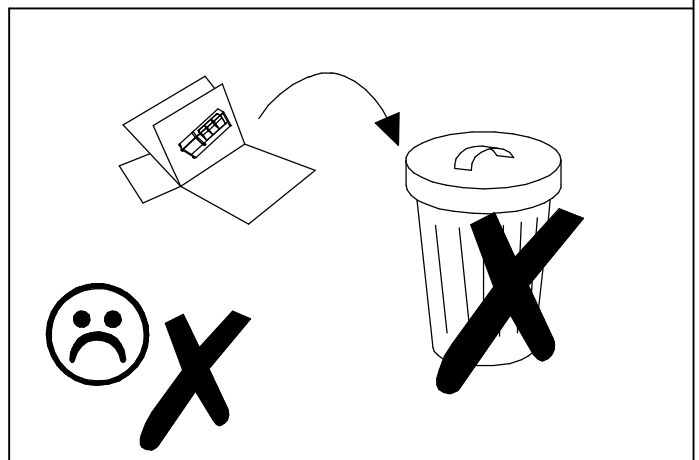
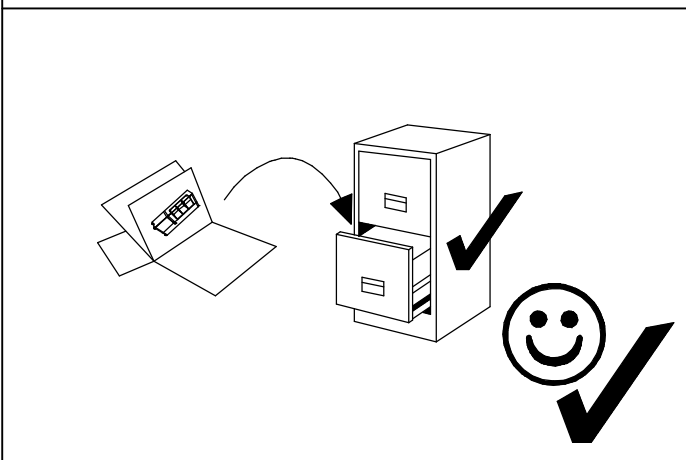
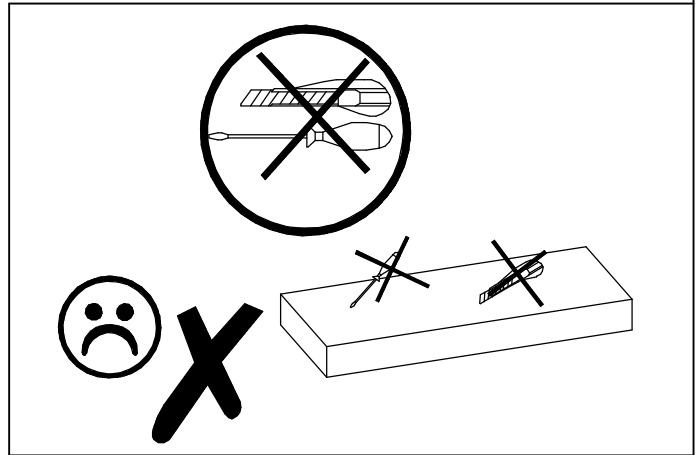
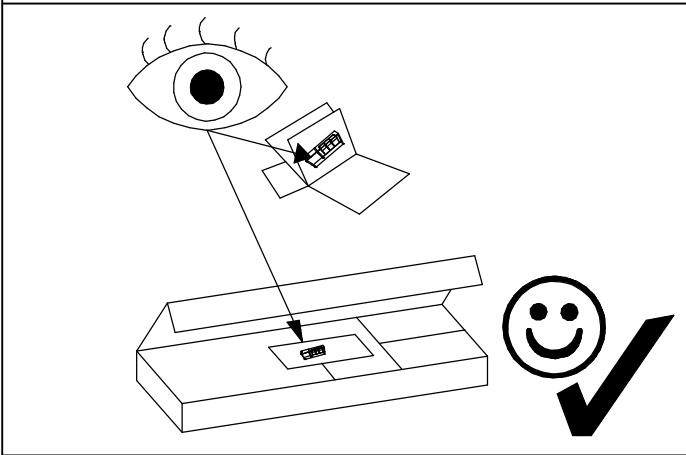

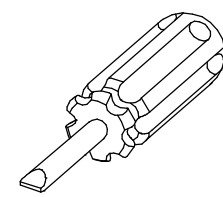
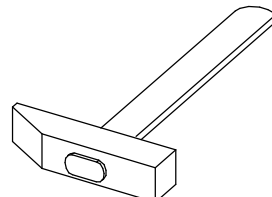
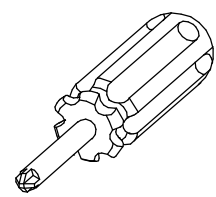
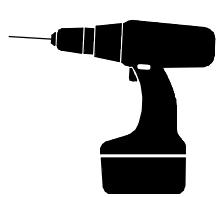
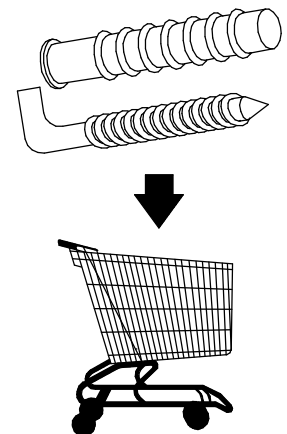
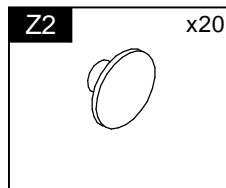
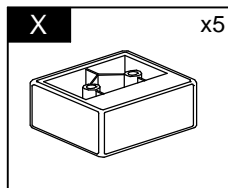
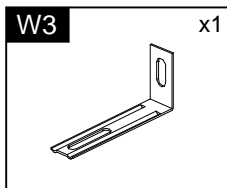
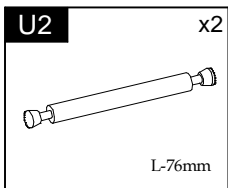
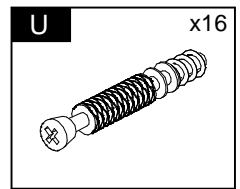
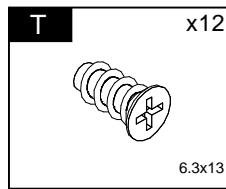
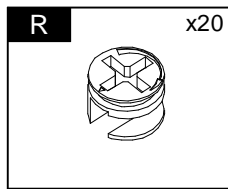
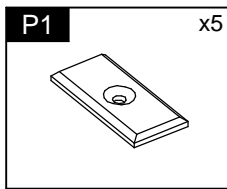
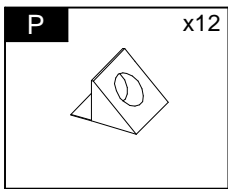
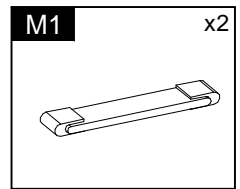
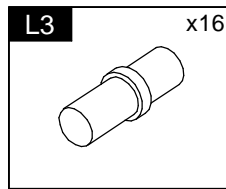
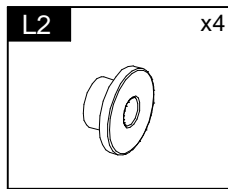
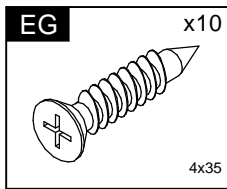
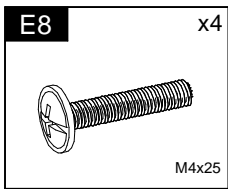
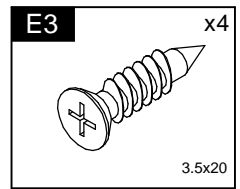
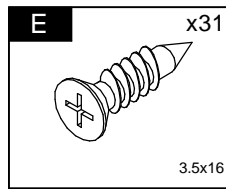
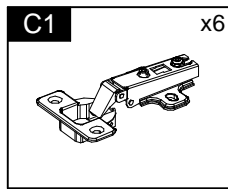
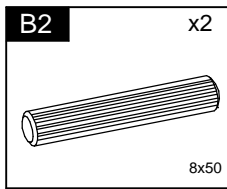
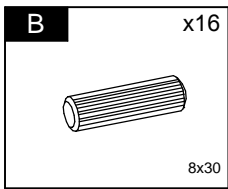
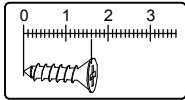

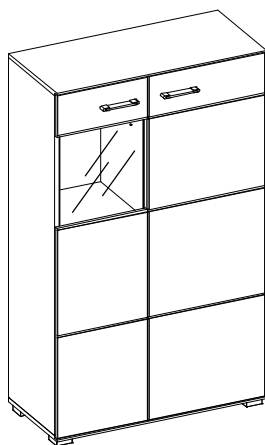

| Element symbol | Measurements |     |    |   | Code      | Paket |
|----------------|--------------|-----|----|---|-----------|-------|
|                | 1            | 2   | 3  | 4 |           |       |
| 1              | 799          | 368 | 16 | 1 | 1002      | 1/3   |
| 2              | 799          | 368 | 16 | 1 | 1003      | 1/3   |
| 3              | 1274         | 351 | 16 | 1 | 1004      | 1/3   |
| 4              | 1274         | 351 | 16 | 1 | 1005      | 1/3   |
| 5              | 1274         | 331 | 16 | 1 | 1006      | 1/3   |
| 6              | 324          | 324 | 16 | 1 | 1008      | 1/3   |
| 7              | 425          | 324 | 16 | 1 | 1011      | 1/3   |
| 8              | 323.5        | 320 | 16 | 2 | N/A       | 1/3   |
| 9              | 424.5        | 320 | 16 | 2 | N/A       | 1/3   |
| 10             | 1288         | 439 | 3  | 1 | 1007      | 2/3   |
| 11             | 1288         | 339 | 3  | 1 | N/A       | 2/3   |
| 12             | 790          | 345 | 16 | 1 | 1004/3009 | 2/3   |
| 13             | 345          | 160 | 16 | 1 | 1005/3010 | 2/3   |
| 14             | 1290         | 445 | 16 | 1 | 1006/3012 | 2/3   |
| 15             | 400          | 320 | 4  | 1 | Glass     | 3/3   |

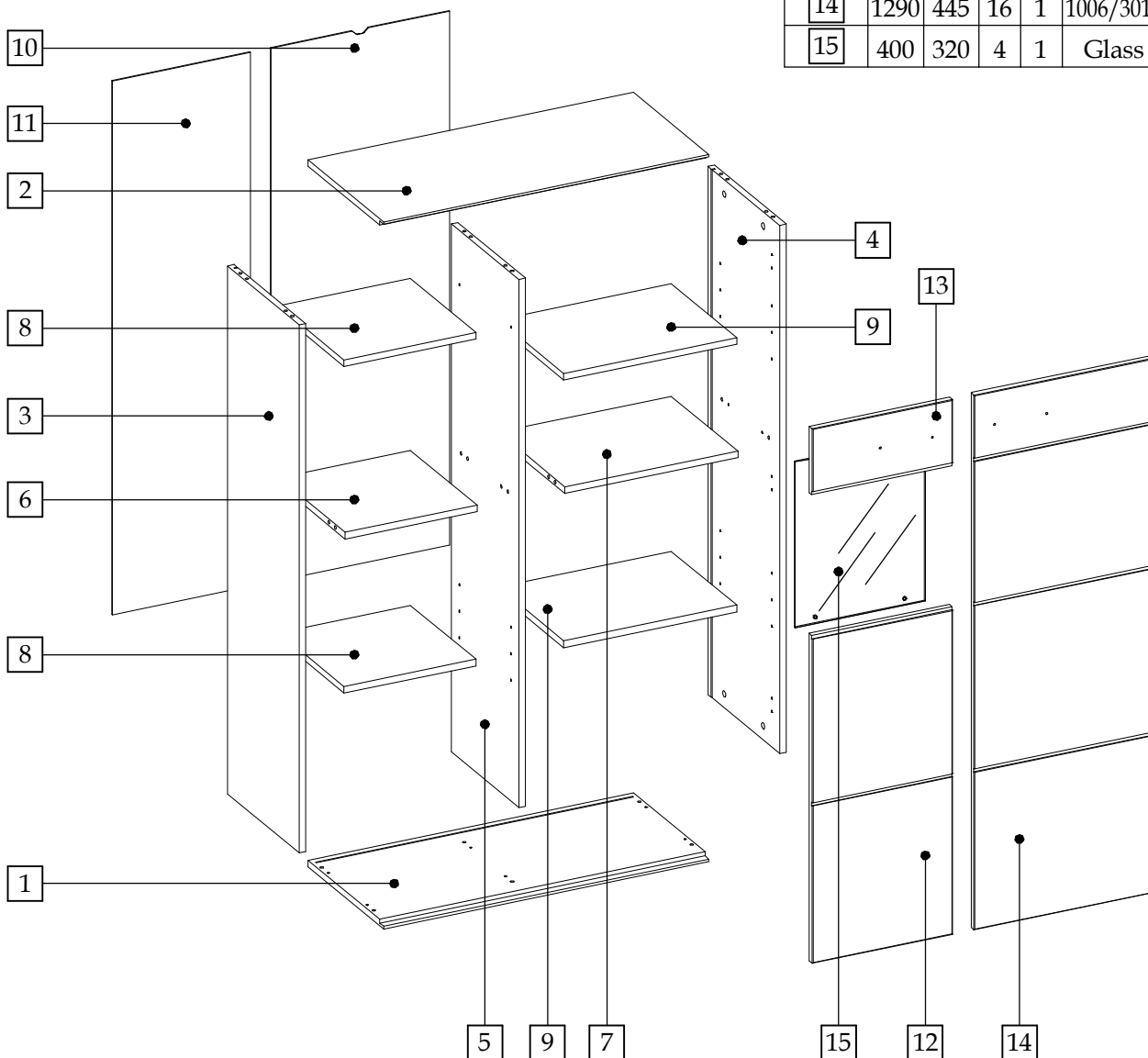



1

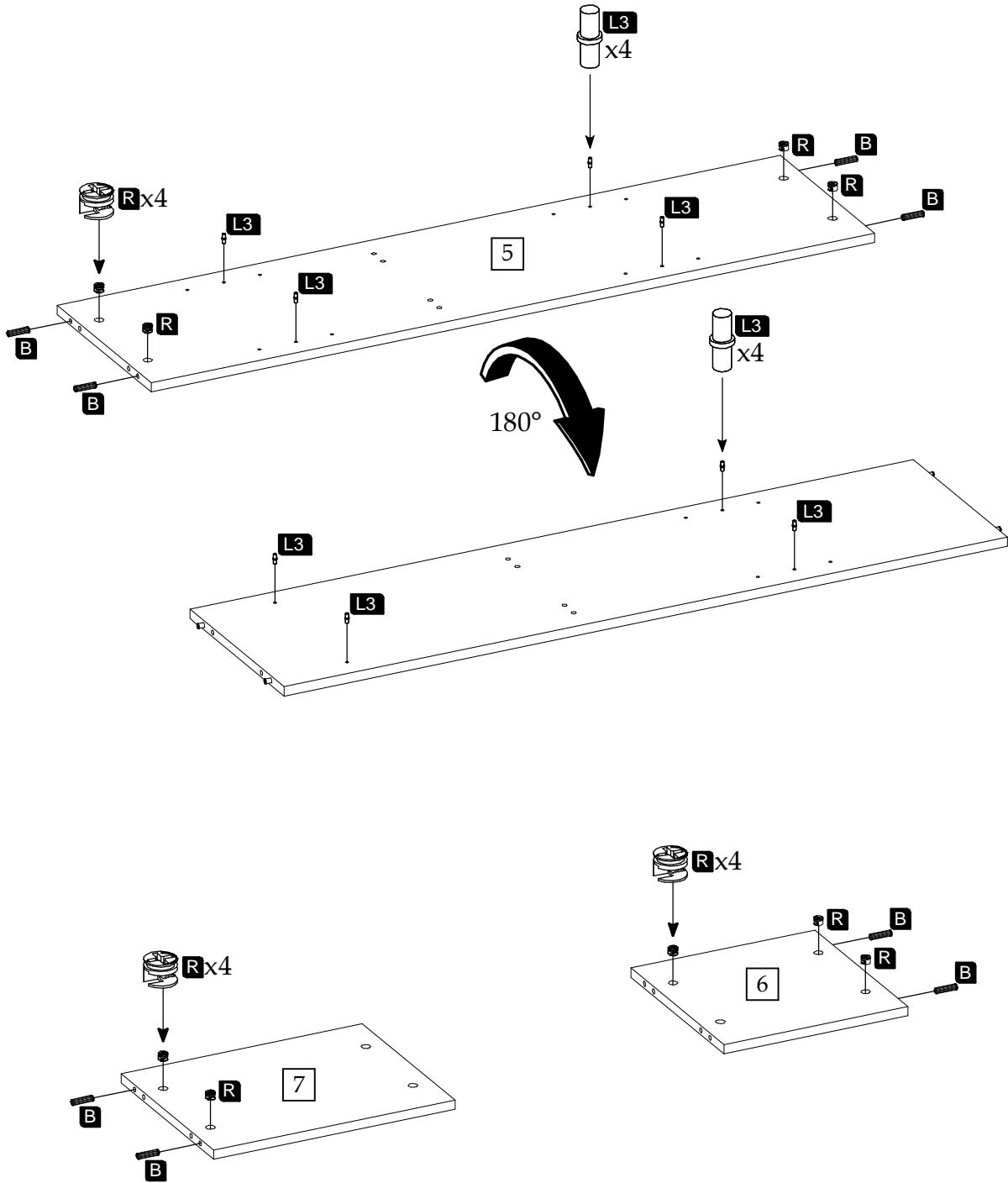

2

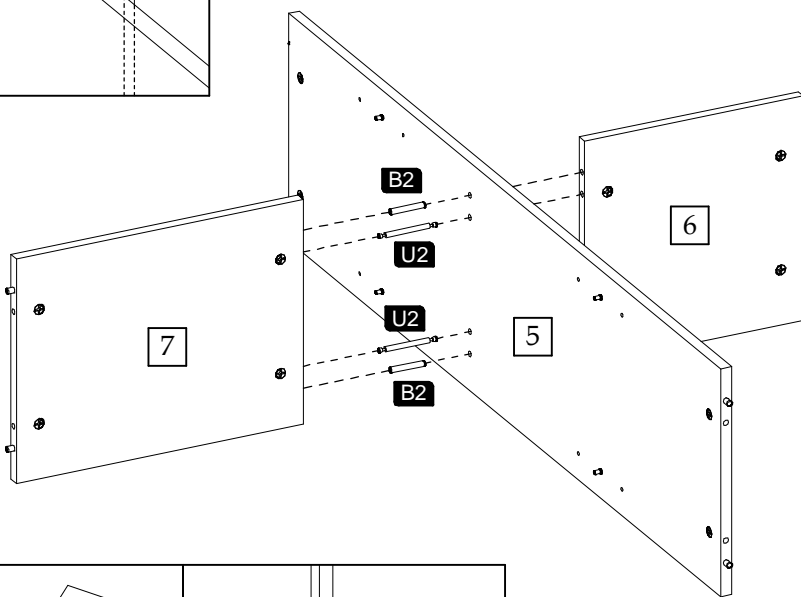
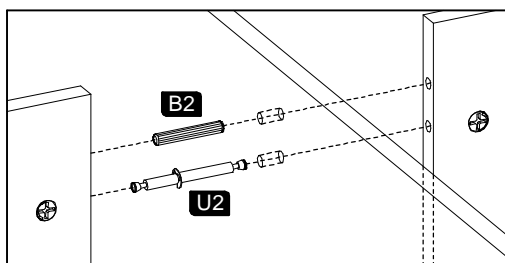

3

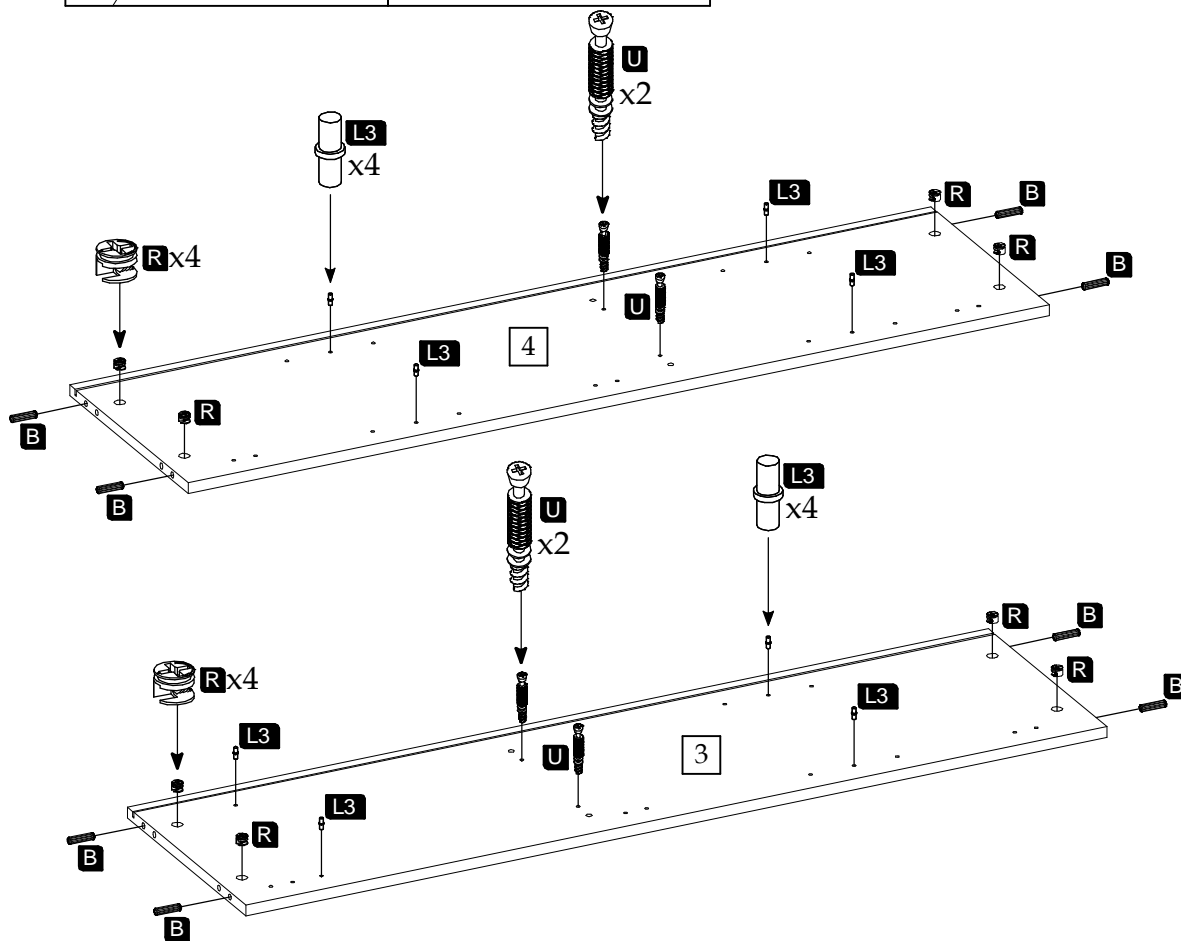
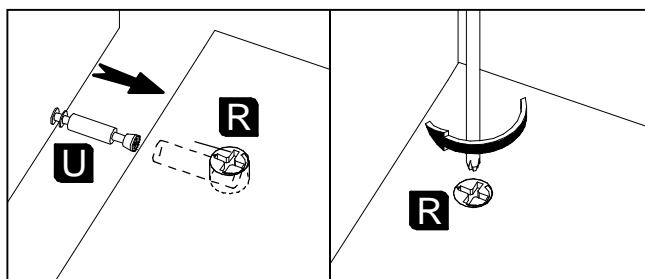

4

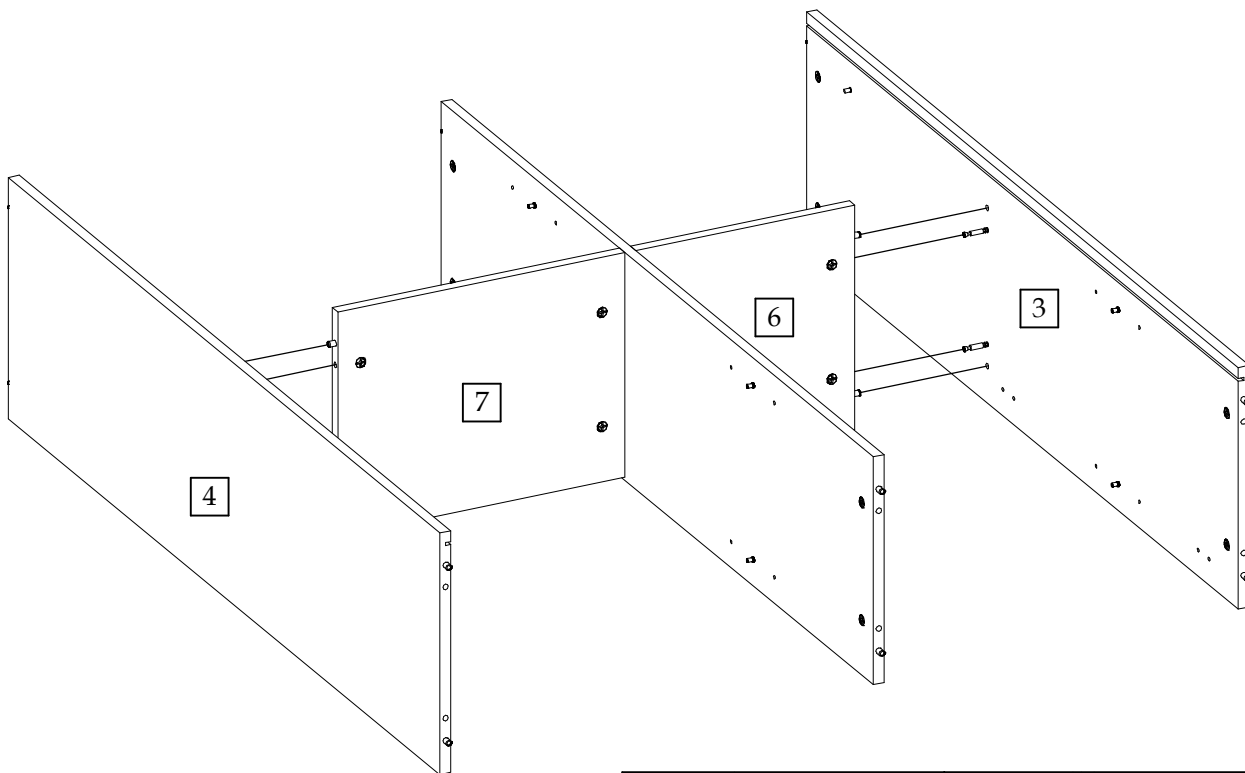

5

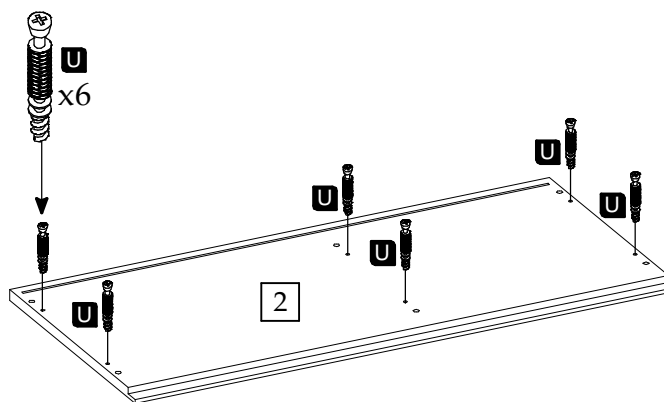
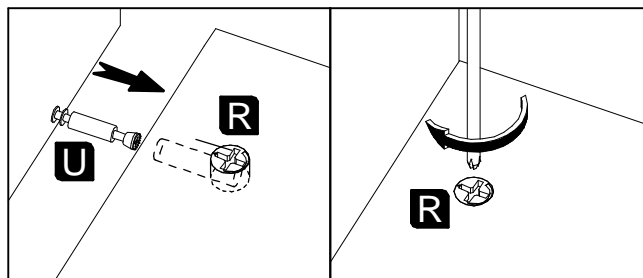

6

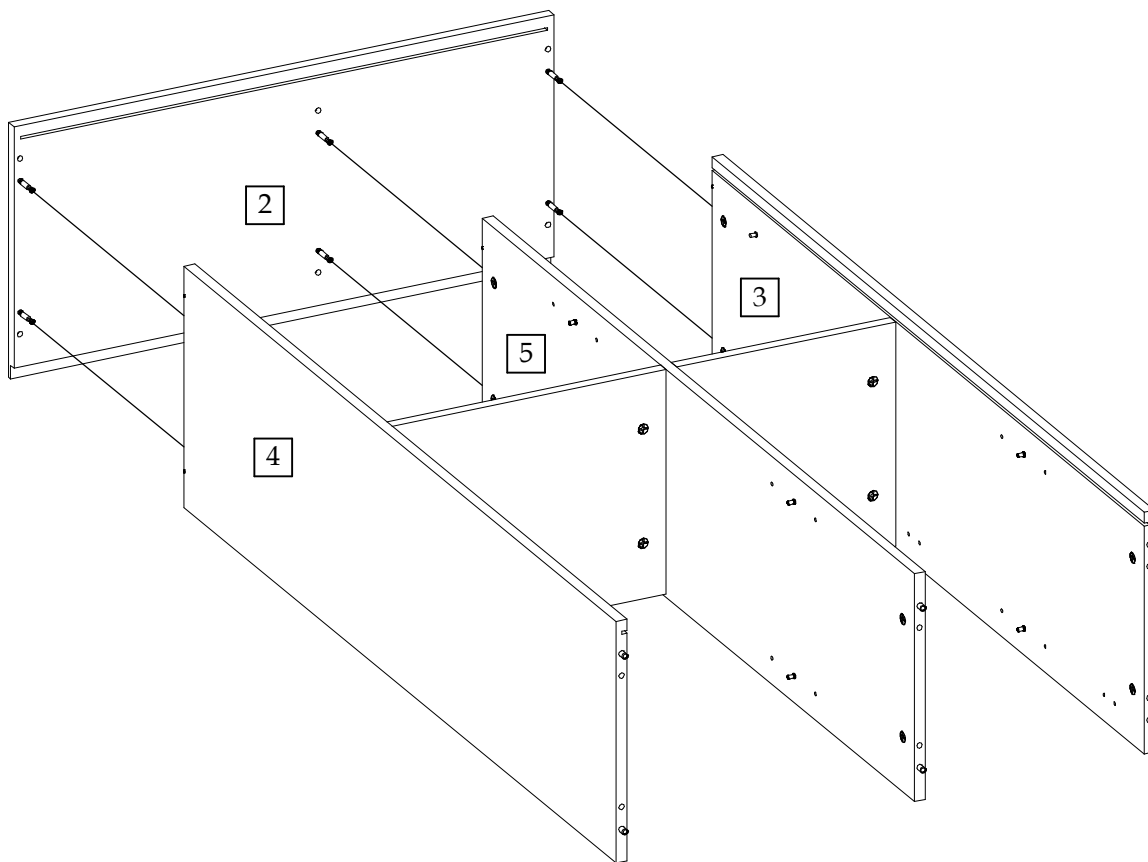

7

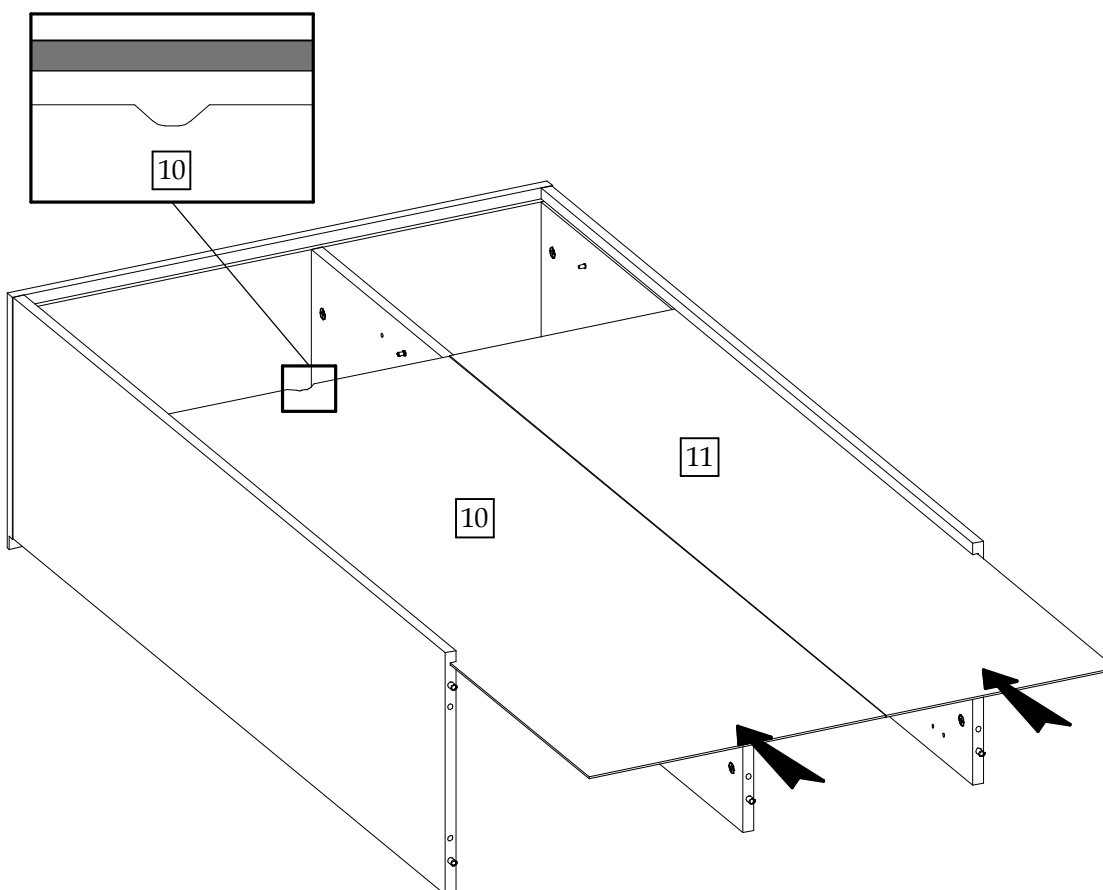



8

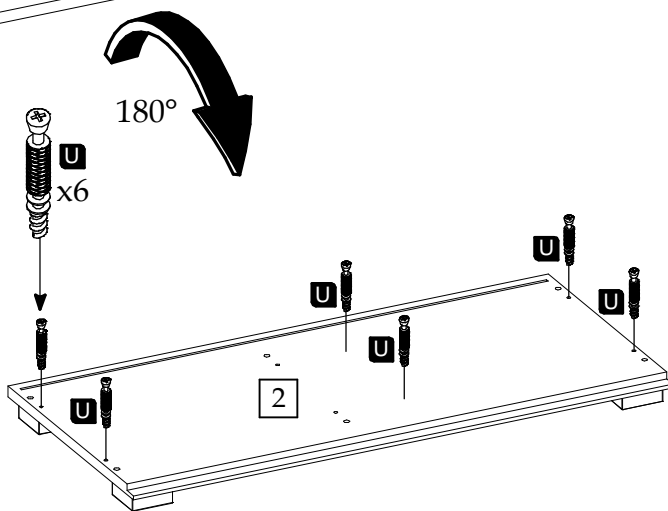
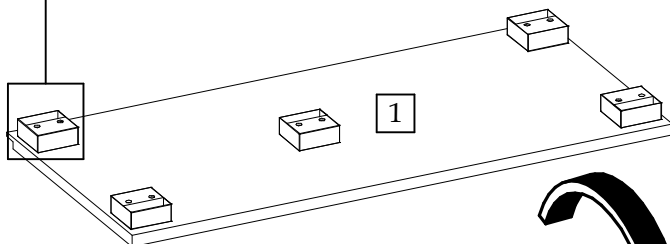
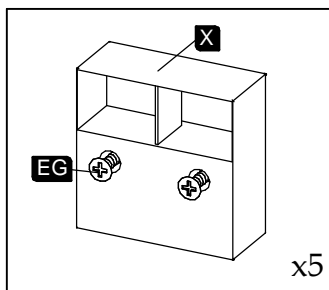

9

