

CONCORD

Typ L

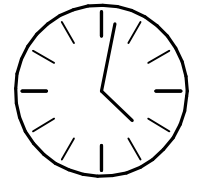

120 min

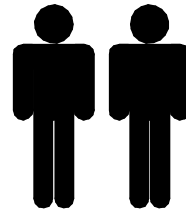
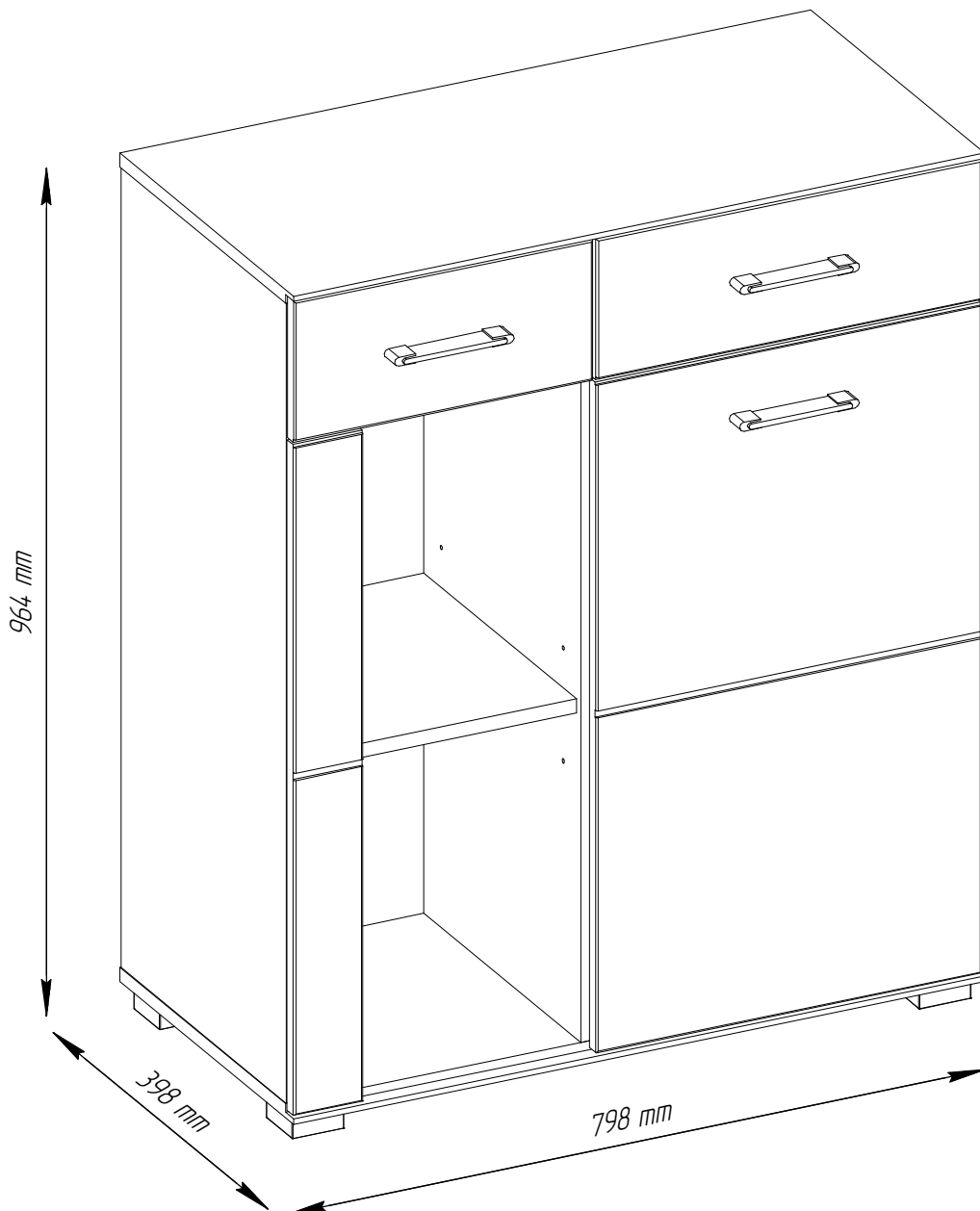

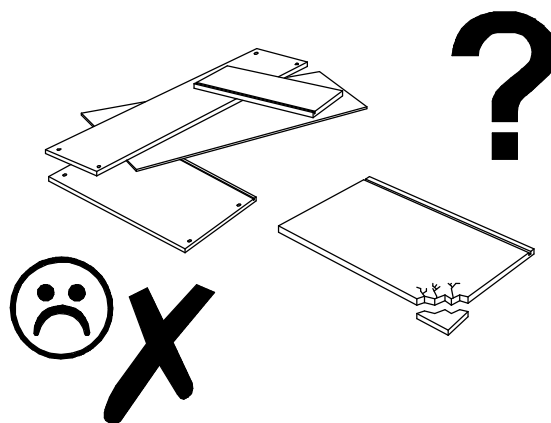
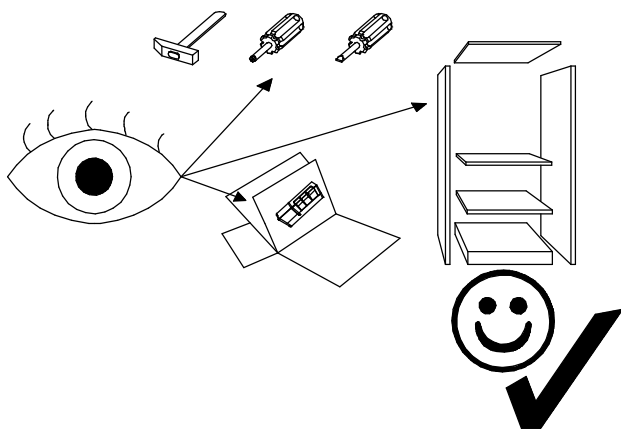
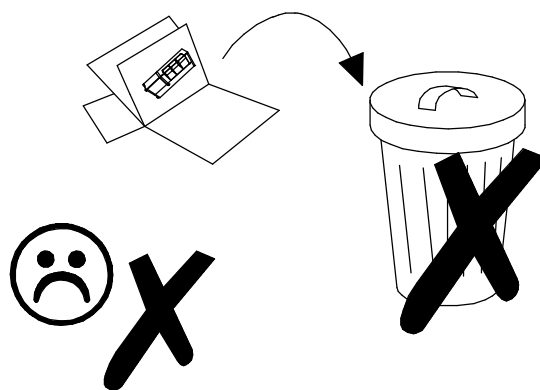
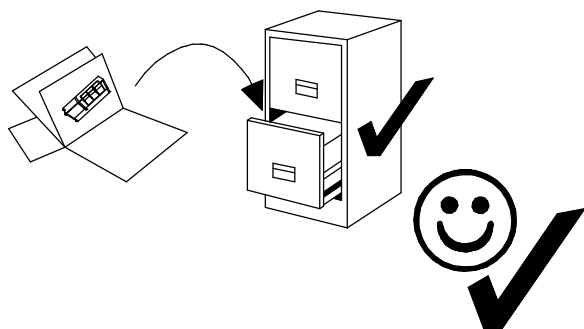
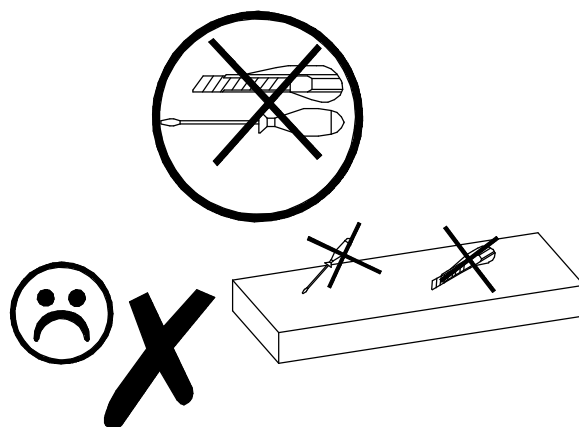
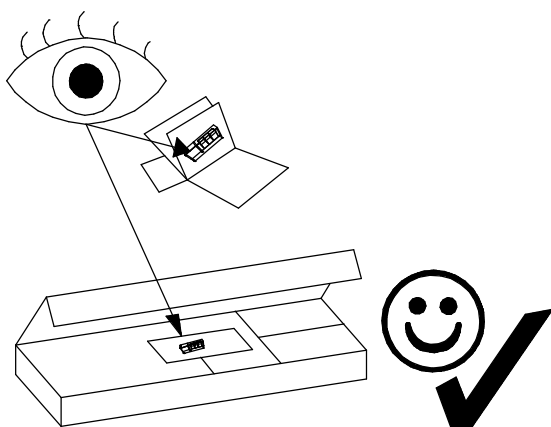

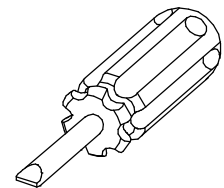
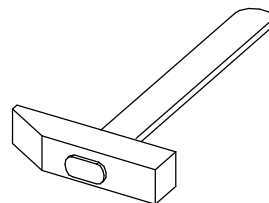
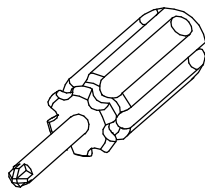
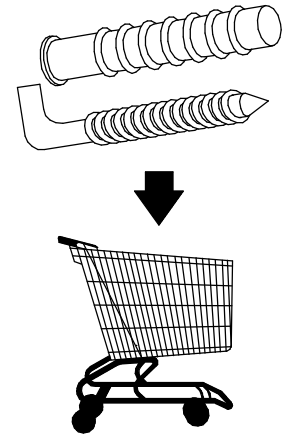
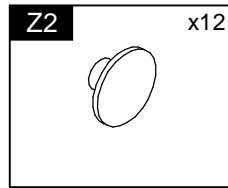
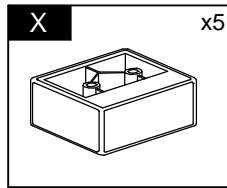
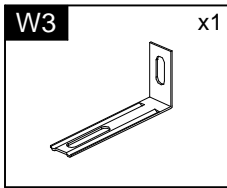
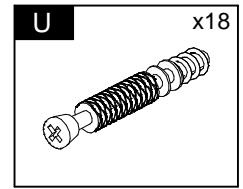
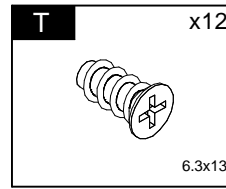
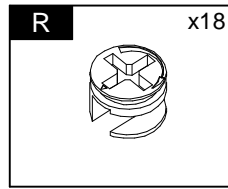
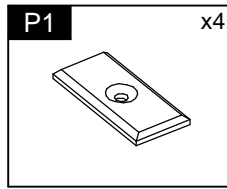
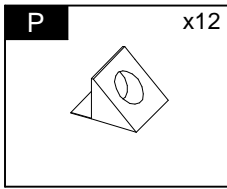
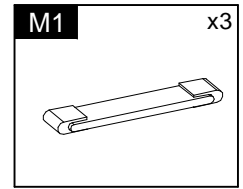
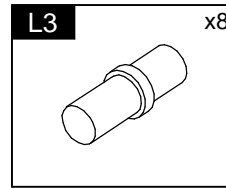
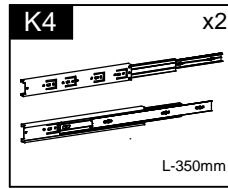
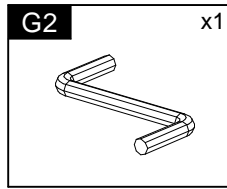
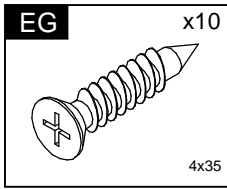
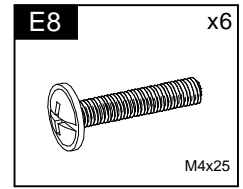
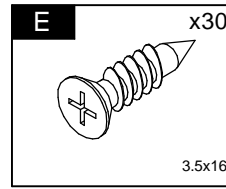
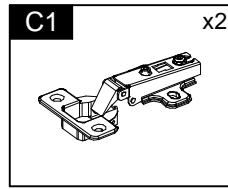
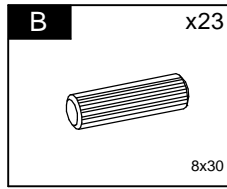
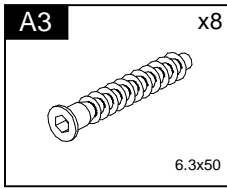
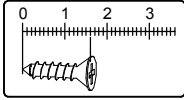

Element symbol	Measurements				Code	Paket
1	798	398	16	1	1001	1/2
2	798	398	16	1	1002	1/2
3	907	381	16	1	1003	1/2
4	907	381	16	1	1004	1/2
5	907	361	16	1	1005	1/2
6	323.5	350	16	1	N/A	1/2
7	423.5	350	16	1	N/A	1/2
8	350	110	16	2	1011	1/2 2/2
9	350	110	16	2	1013	1/2

10	266.5	110	16	1	1012	2/2
11	366.5	110	16	1	1019	1/2
12	380.5	346	3	1	N/A	2/2
13	280.5	346	3	1	N/A	2/2
14	921	439	3	1	1007	1/2
15	921	339	3	1	N/A	1/2
16	760	445	16	1	1013/3016	2/2
17	345	160	16	1	1005/3010	2/2
18	445	160	16	1	1008/3017	2/2
19	760	80	16	1	1014/3029	2/2

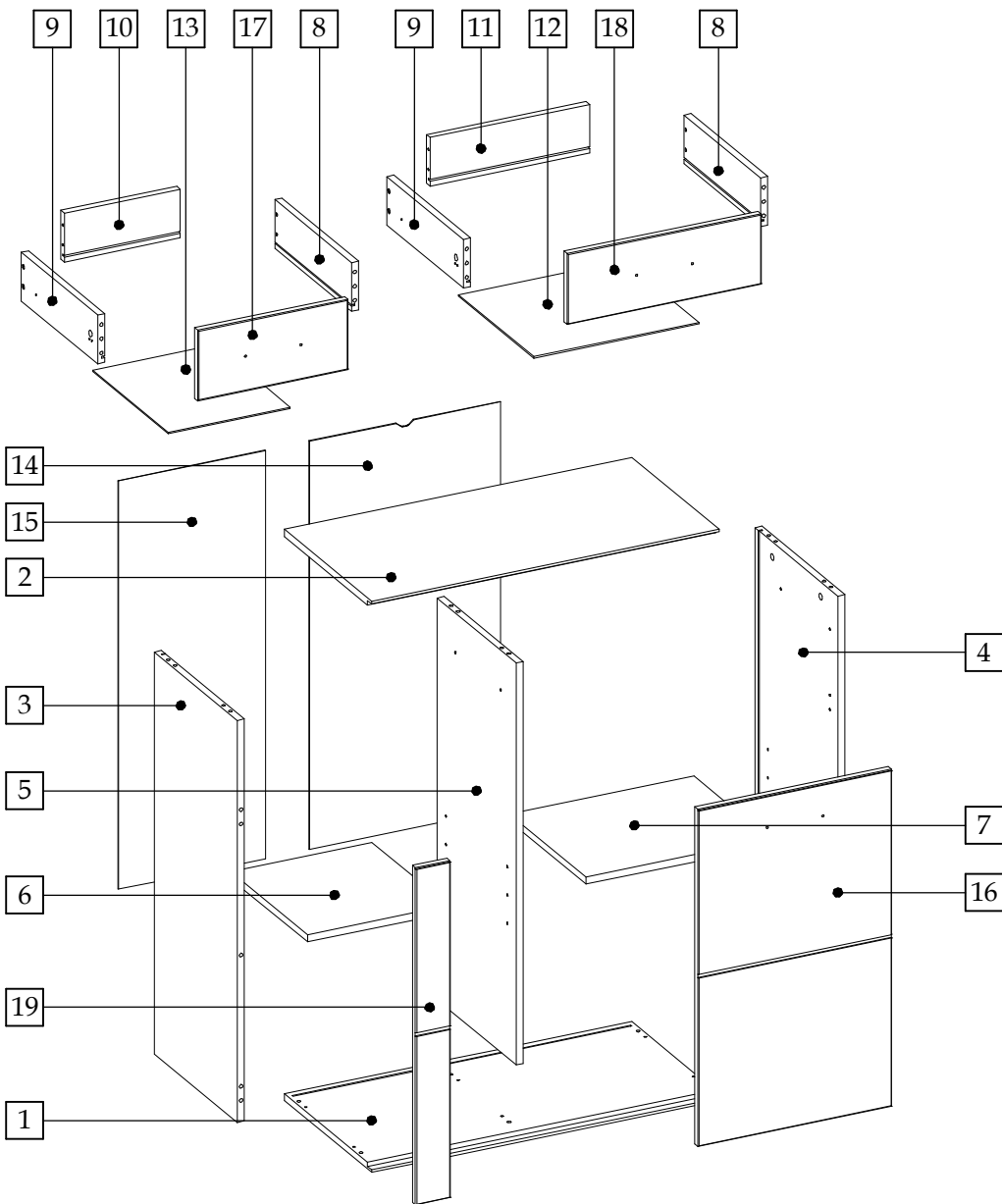

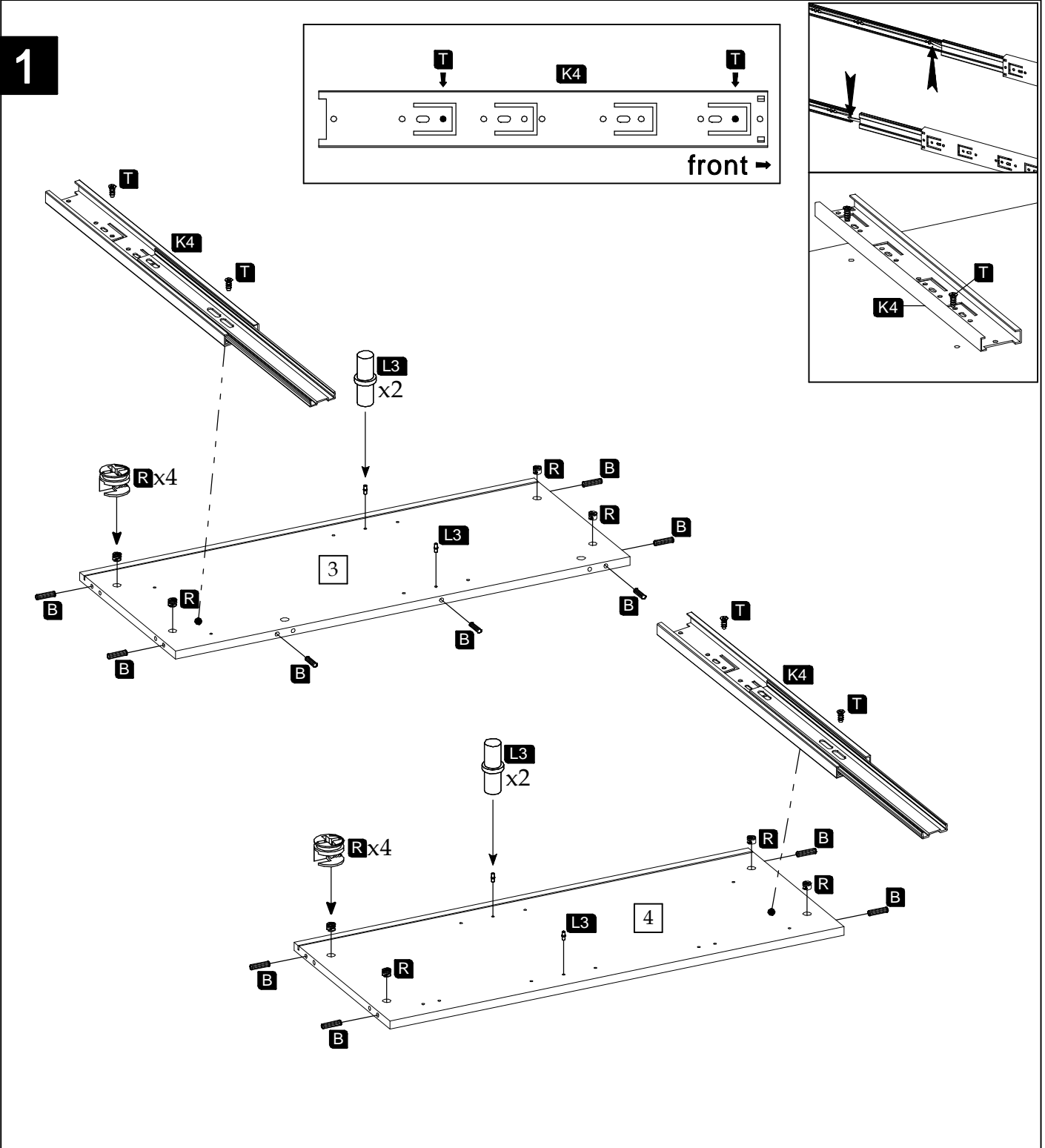
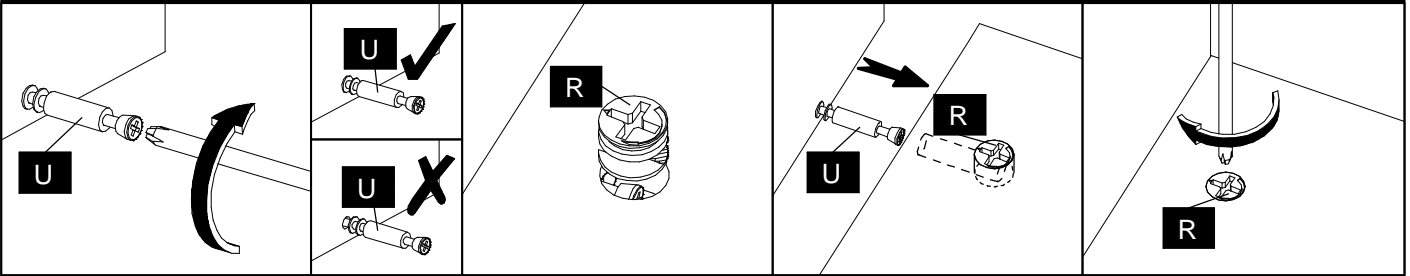

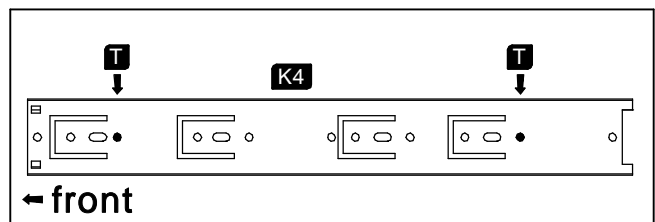
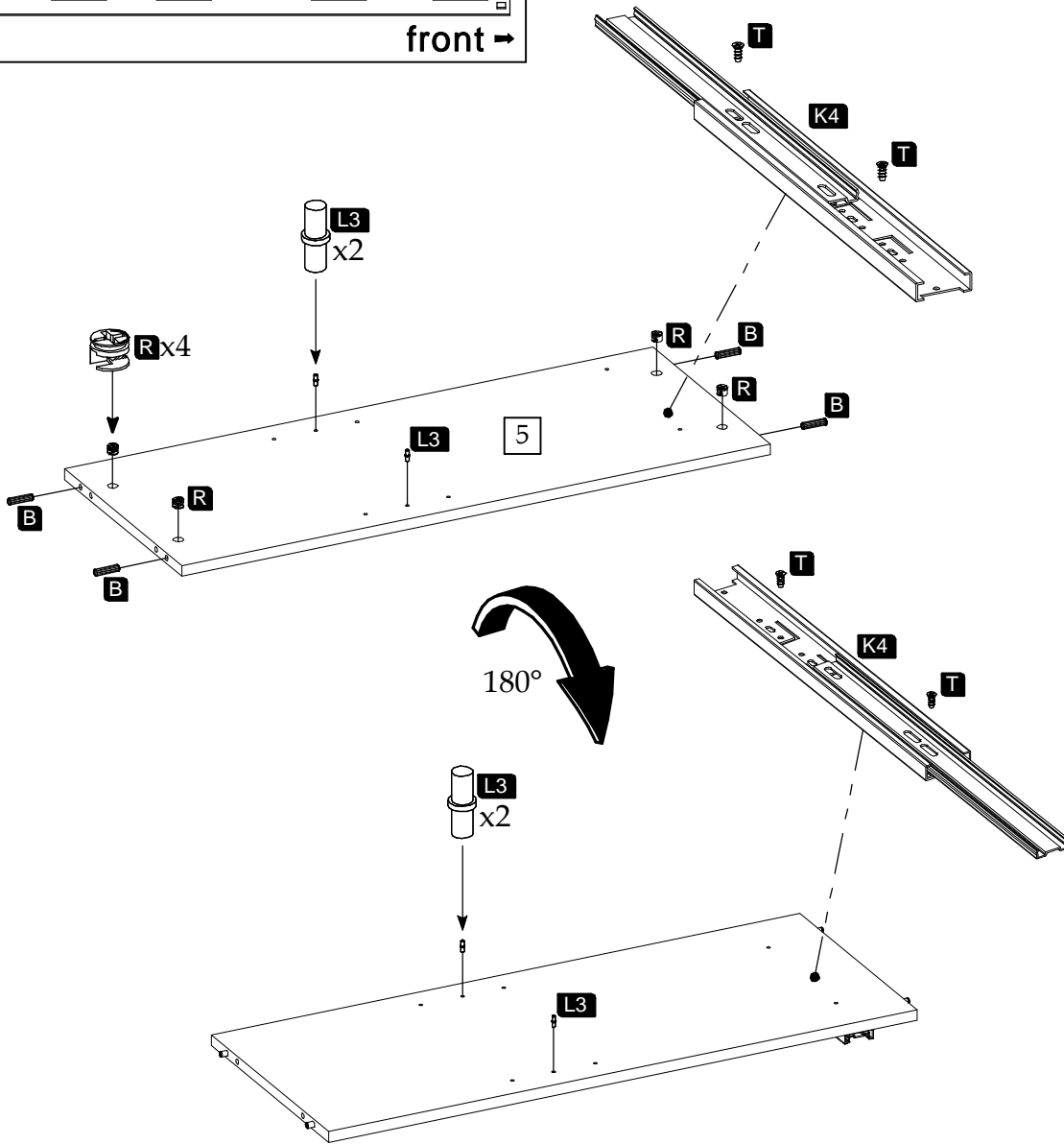
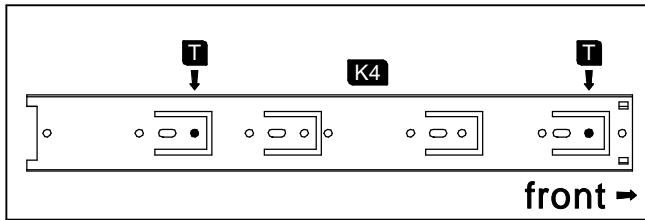

3

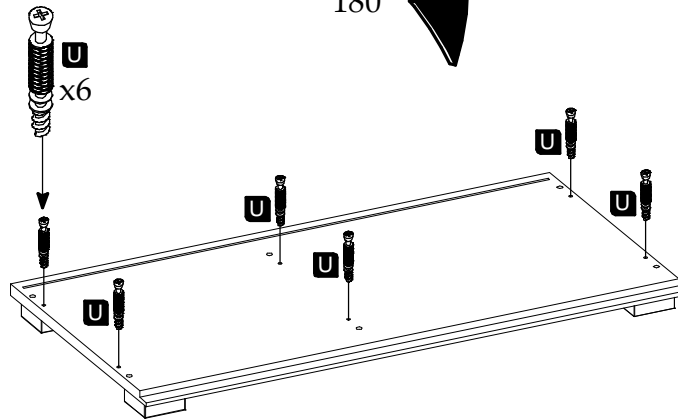
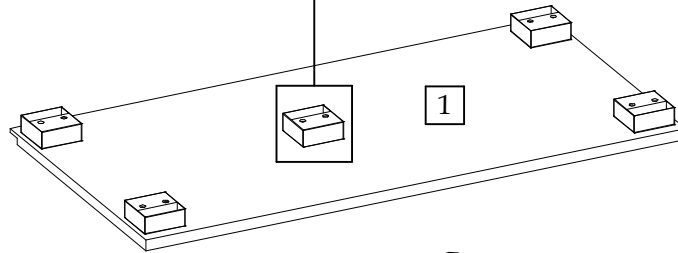
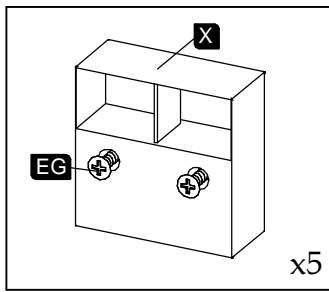

4

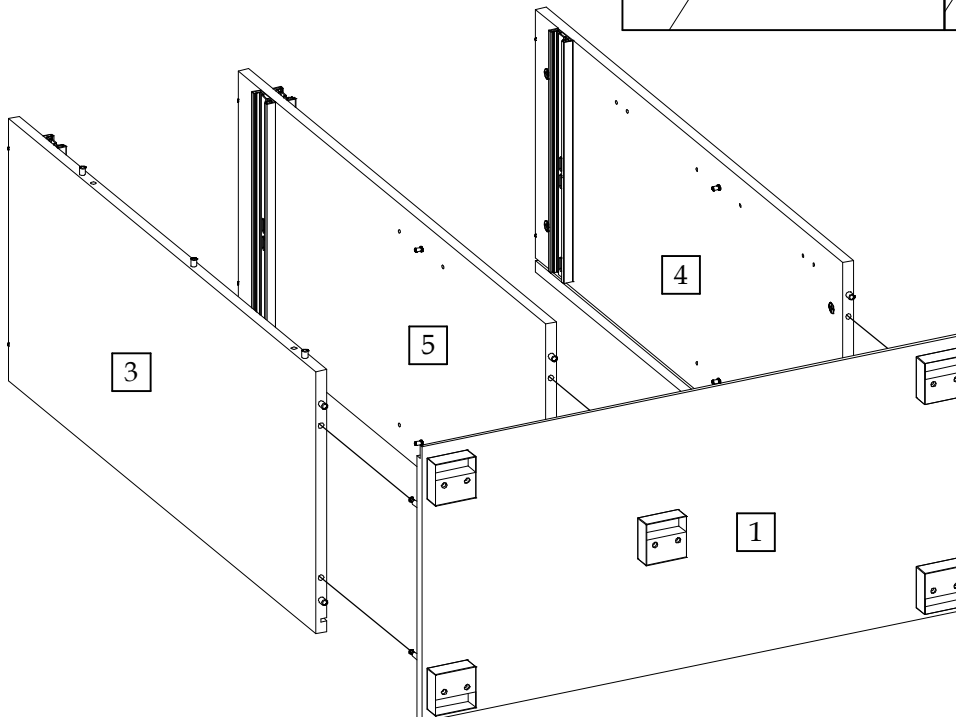
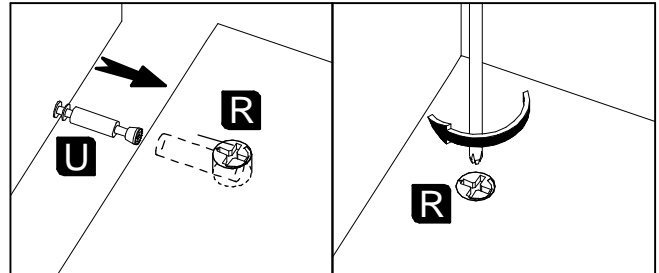

5

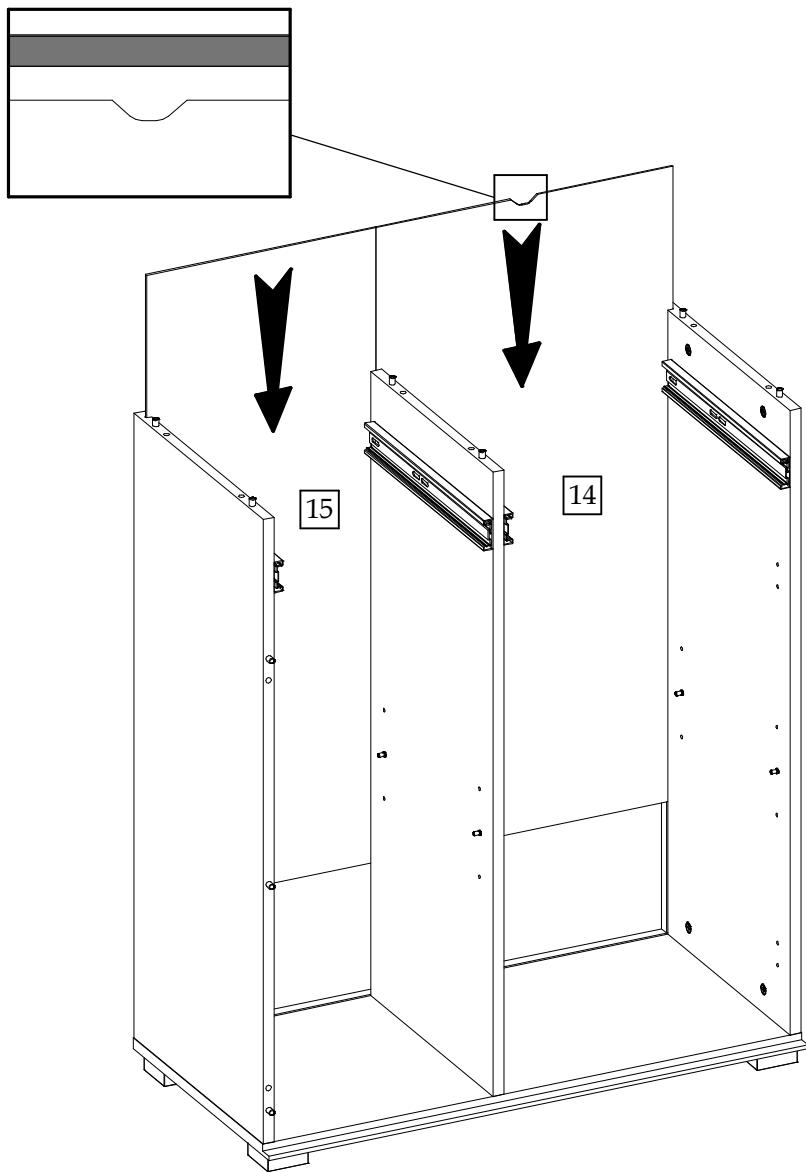

6

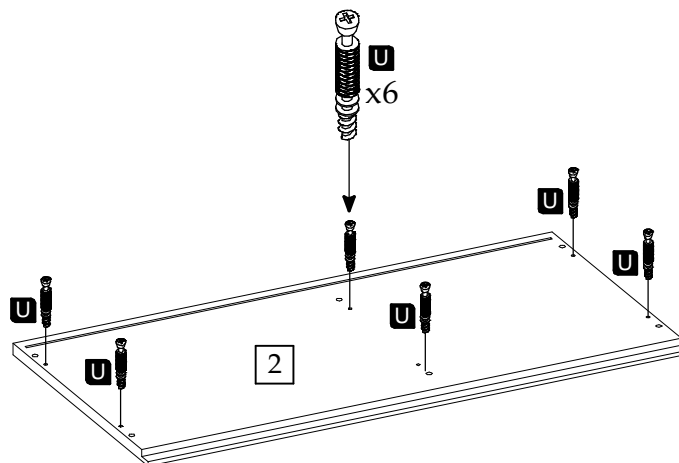

7

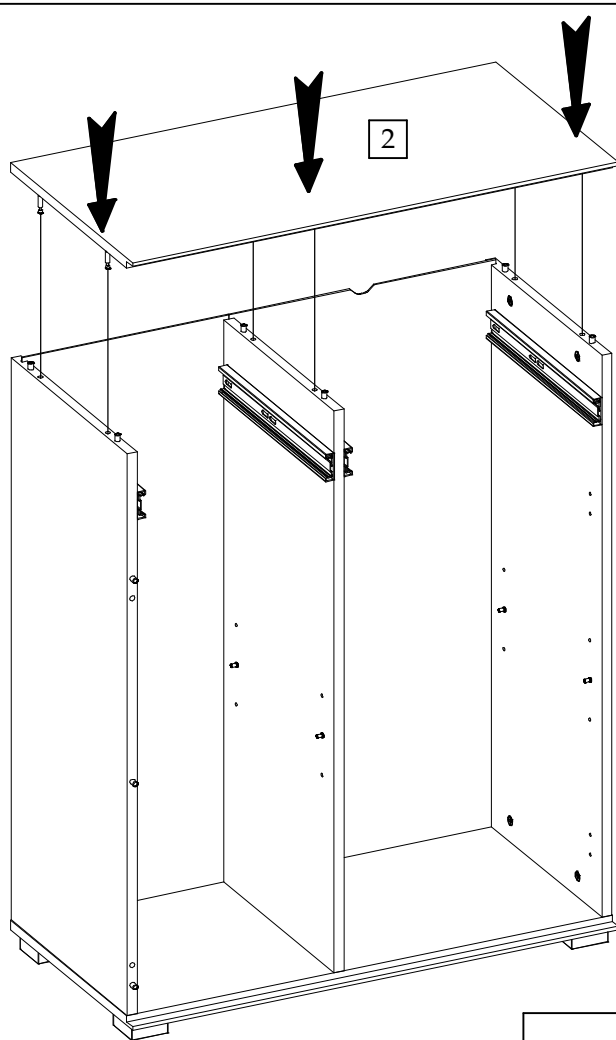

8

