

CONCORD

Typ B

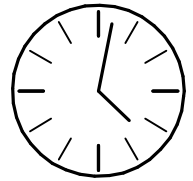

90 min

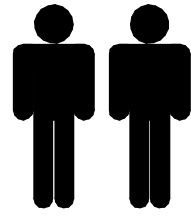
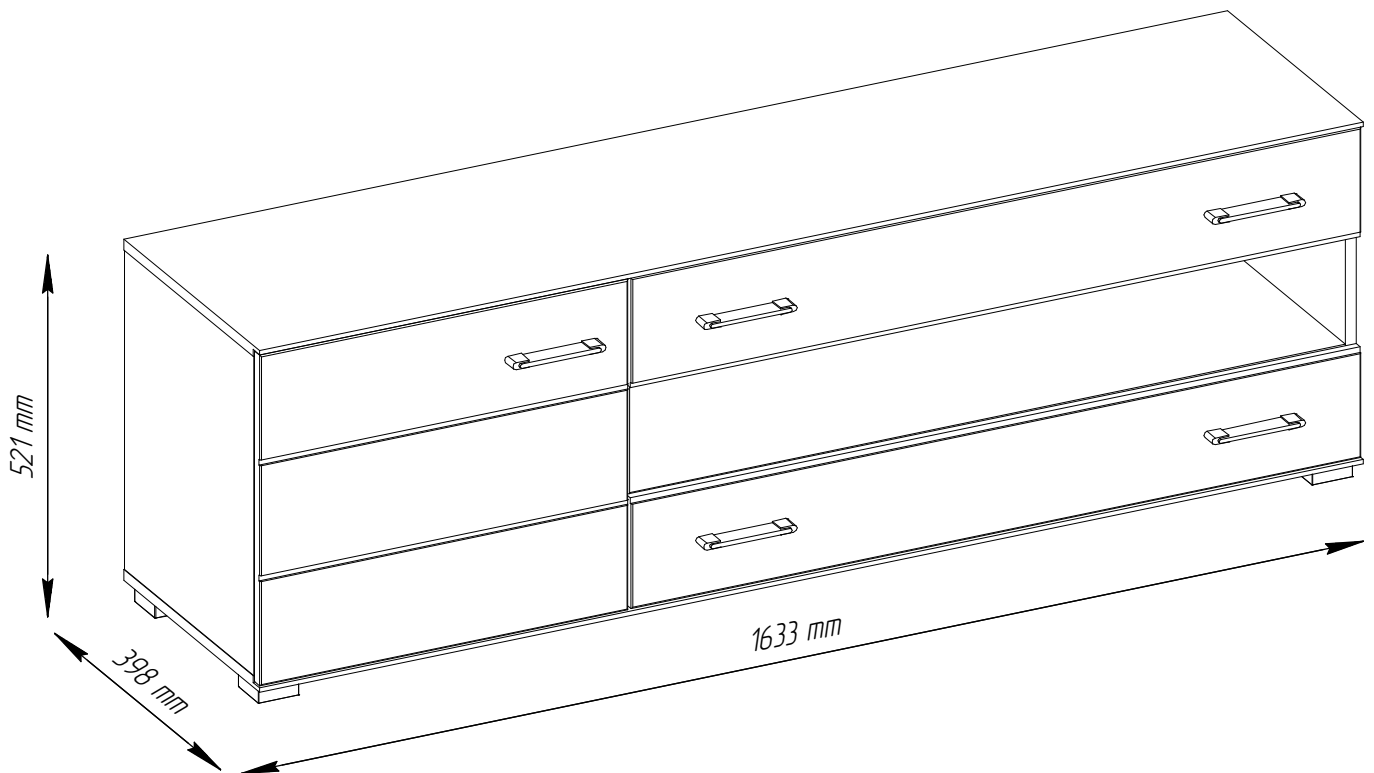

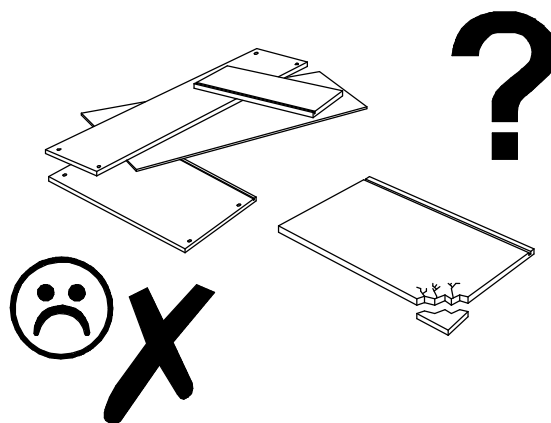
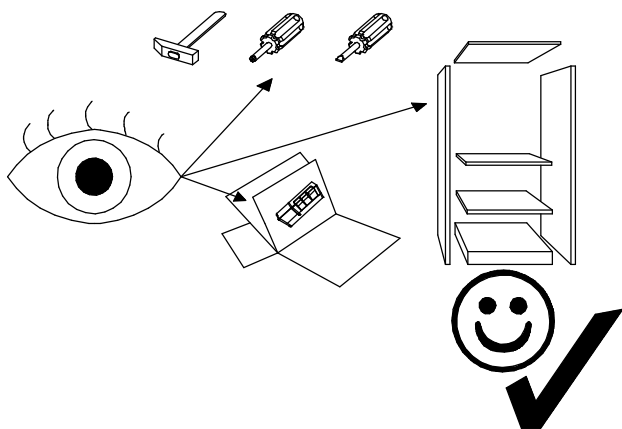
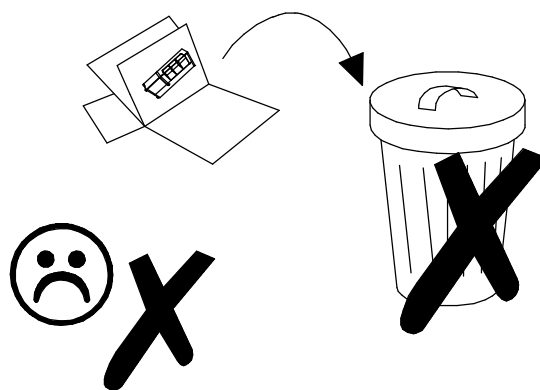
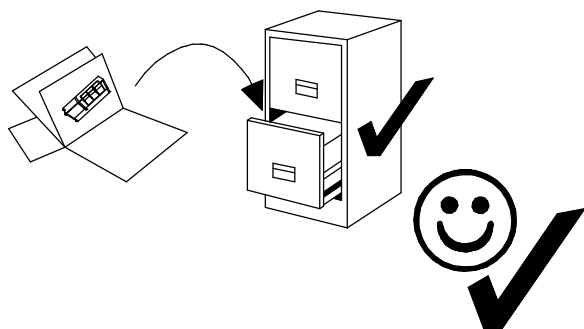
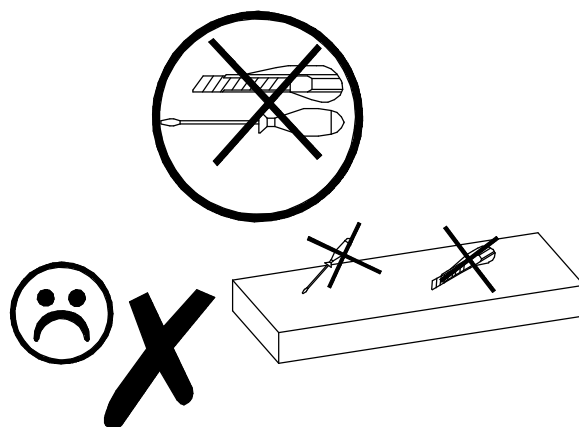
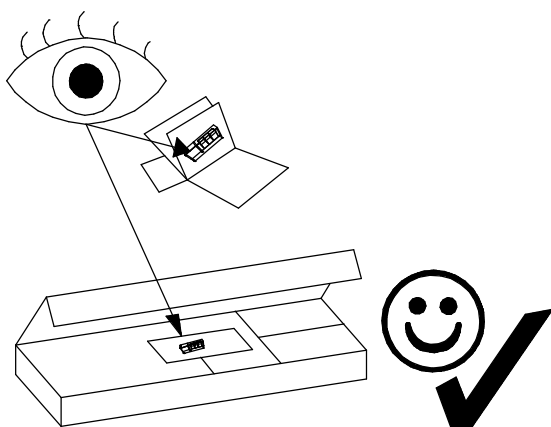

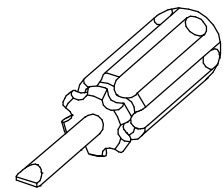
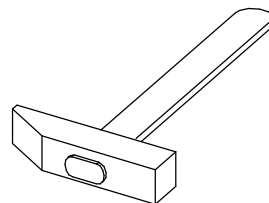
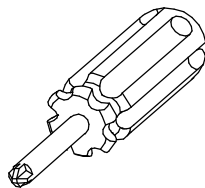
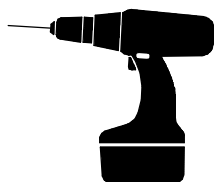
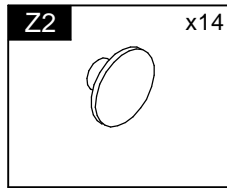
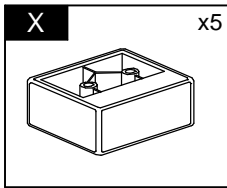
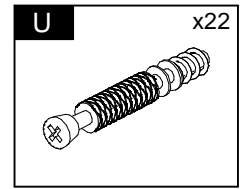
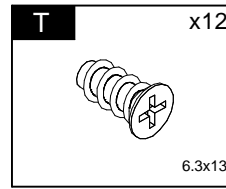
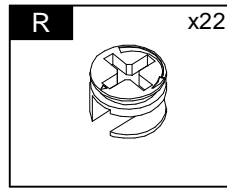
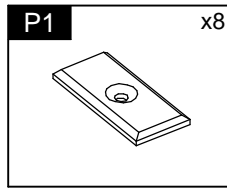
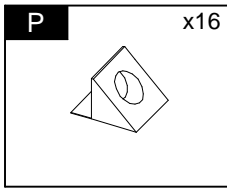
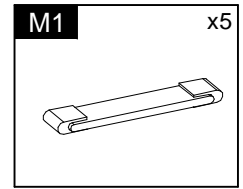
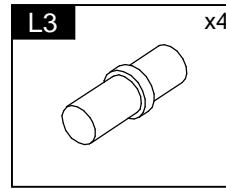
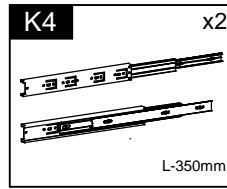
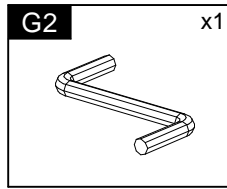
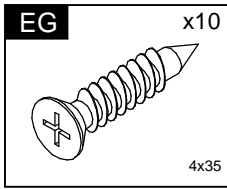
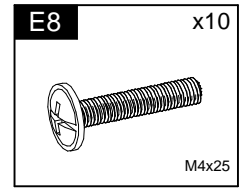
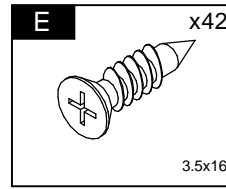
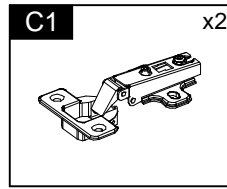
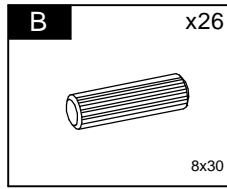
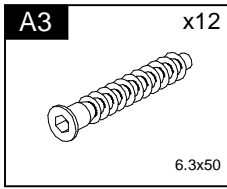
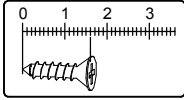

Element symbol	Measurements				Code	Paket
1	1633	398	16	1	1001	1/2
2	1633	398	16	1	1002	1/2
3	464	381	16	1	1003	1/2
4	464	381	16	1	1004	1/2
5	464	361	16	1	1005	1/2
6	523.5	350	16	1	N/A	1/2
7	1059	360.5	16	1	1032	1/2
8	350	110	16	2	1039	1/2
9	350	110	16	2	1041	1/2

10	334	90	16	2	1048	1/2
11	1001.5	110	16	2	1040	1/2
12	1015.5	346	3	2	N/A	1/2
13	539	478	3	1	N/A	2/2
14	1074	152	3	1	N/A	1/2
15	1074	326	3	1	1007	1/2
16	480	545	16	1	1003/3031	2/2
17	1082	160	16	1	1016/3038	1/2
18	1082	160	16	1	1016/3043	1/2

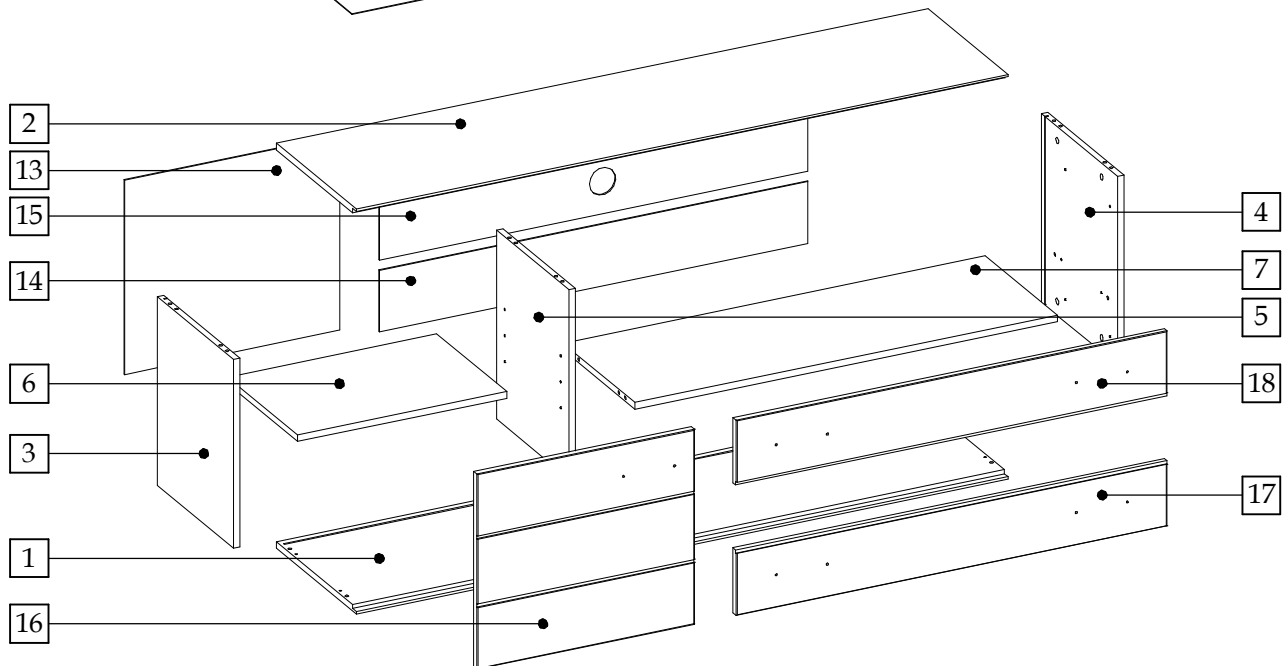
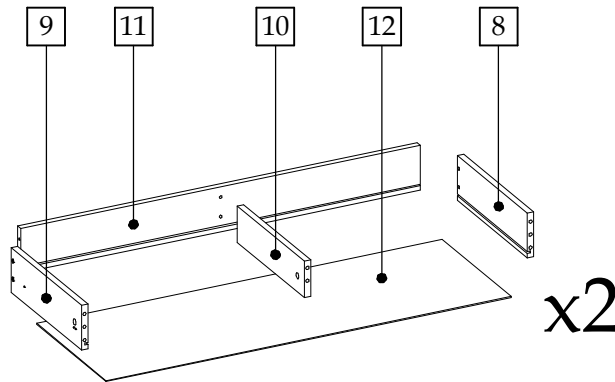

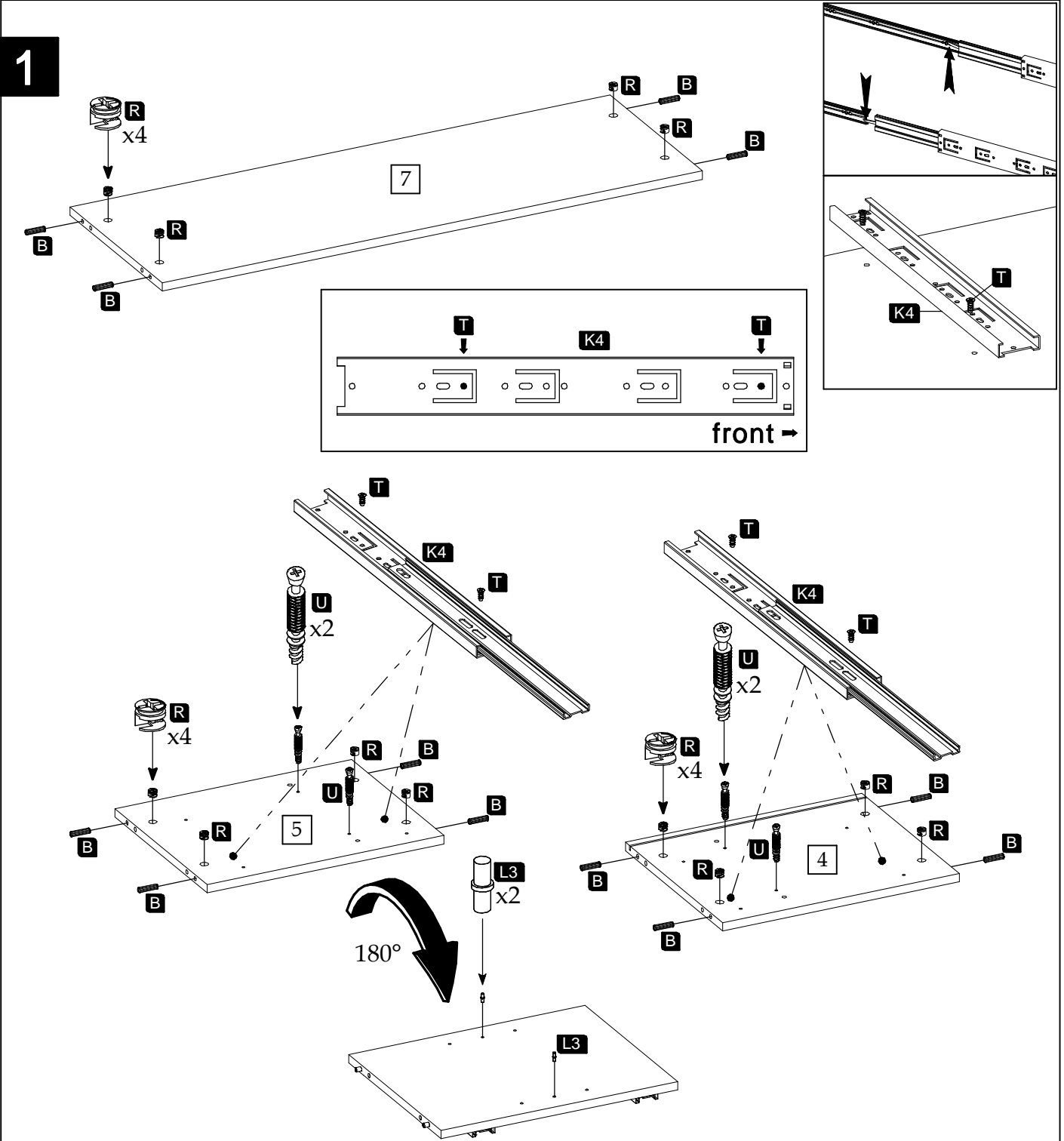
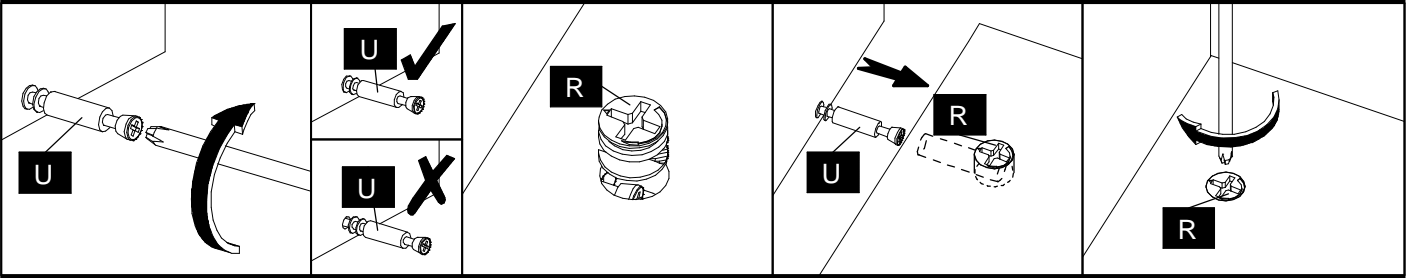

2

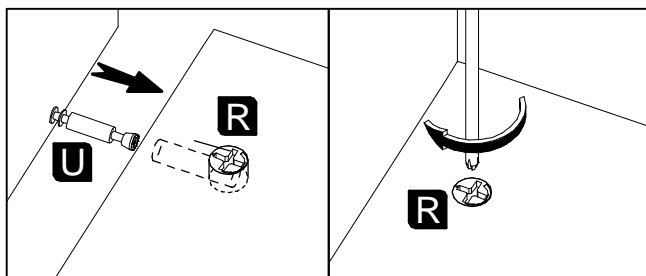
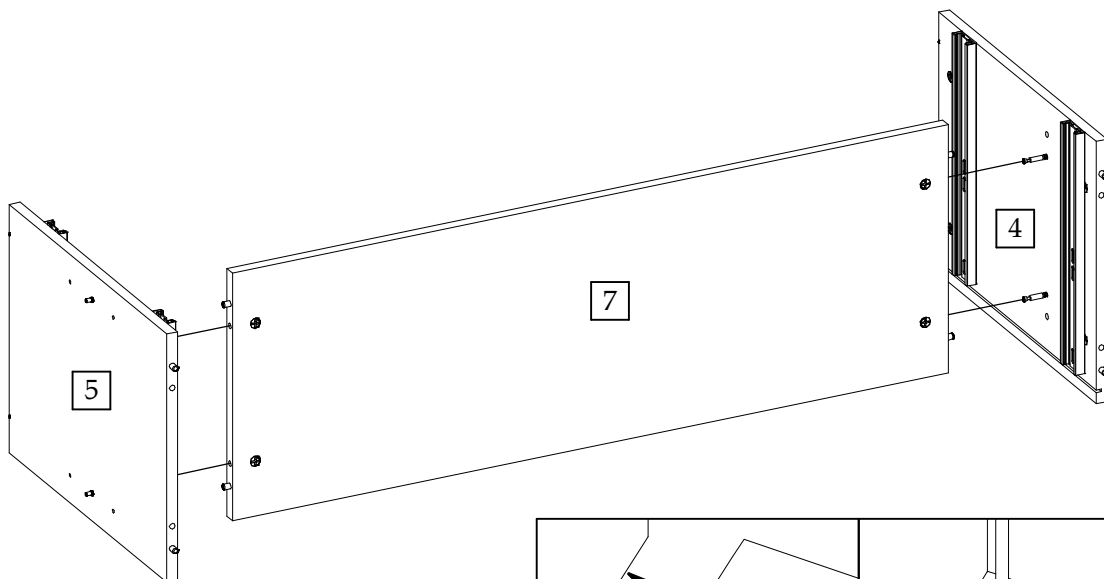

3

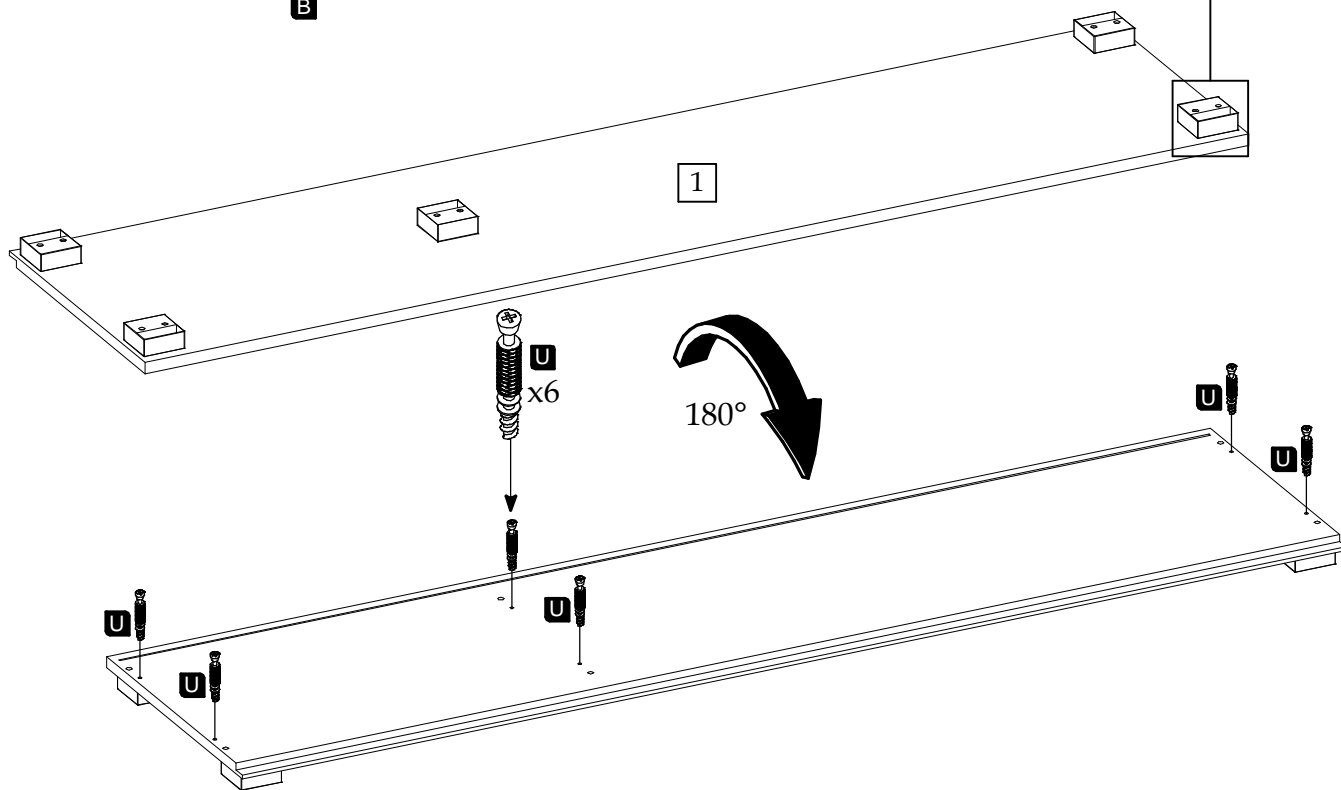
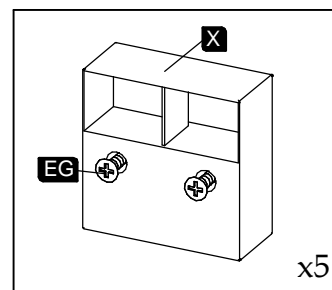
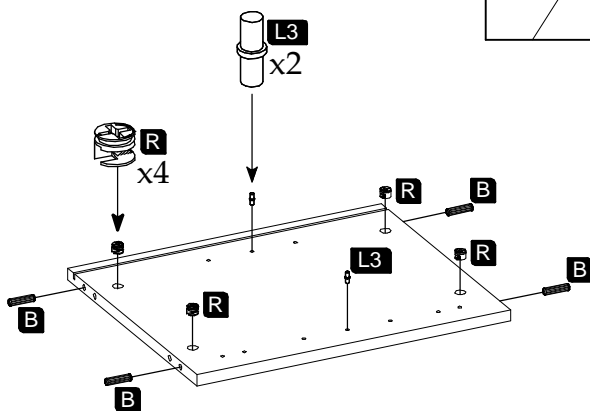

4

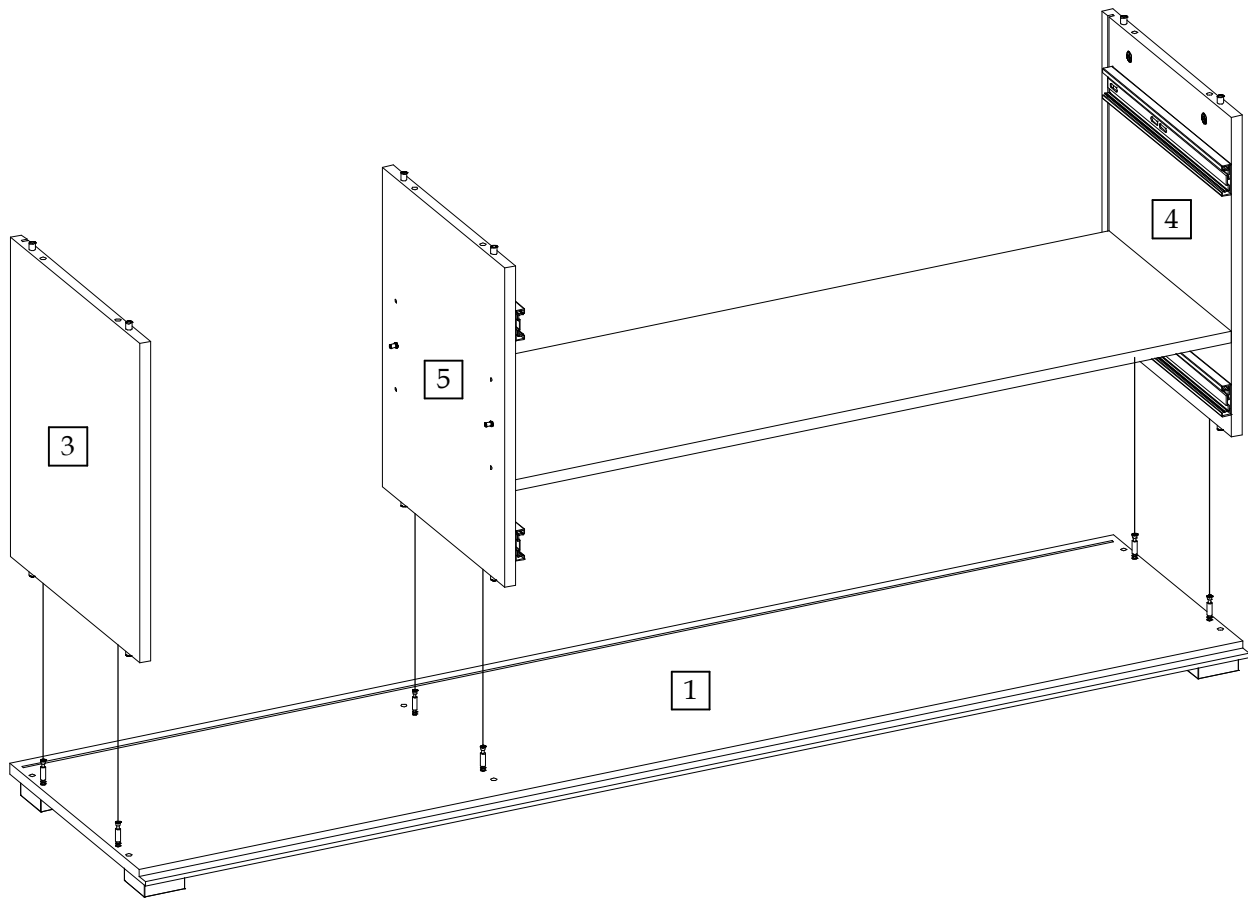

5

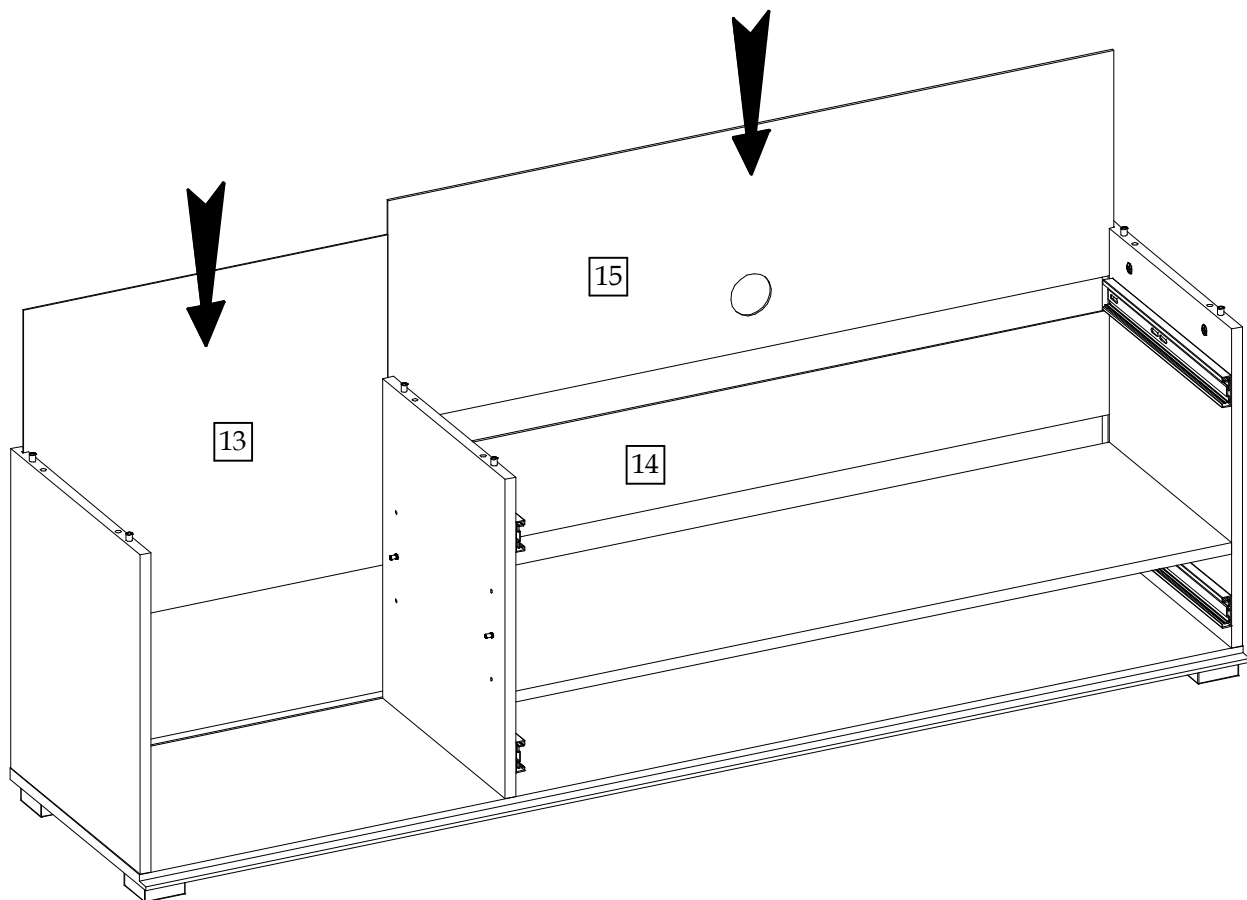

6

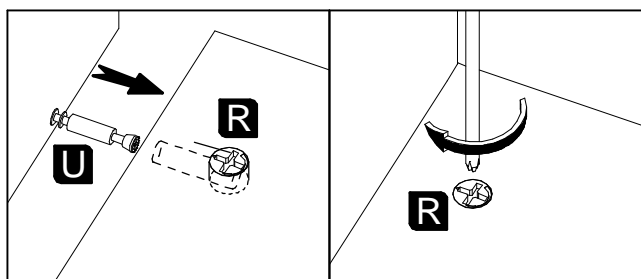
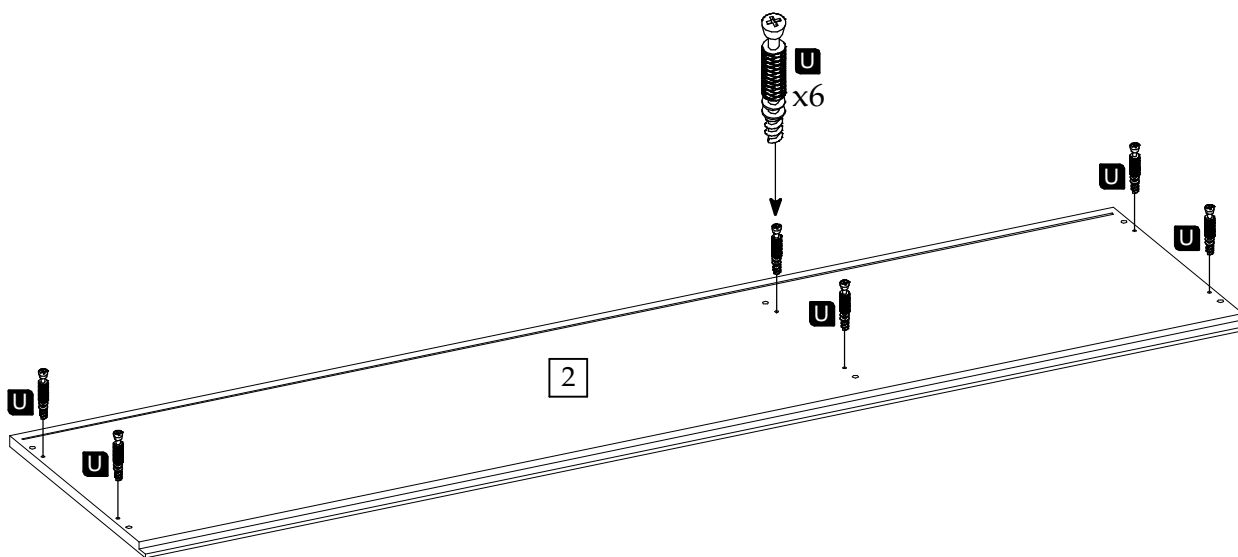

7

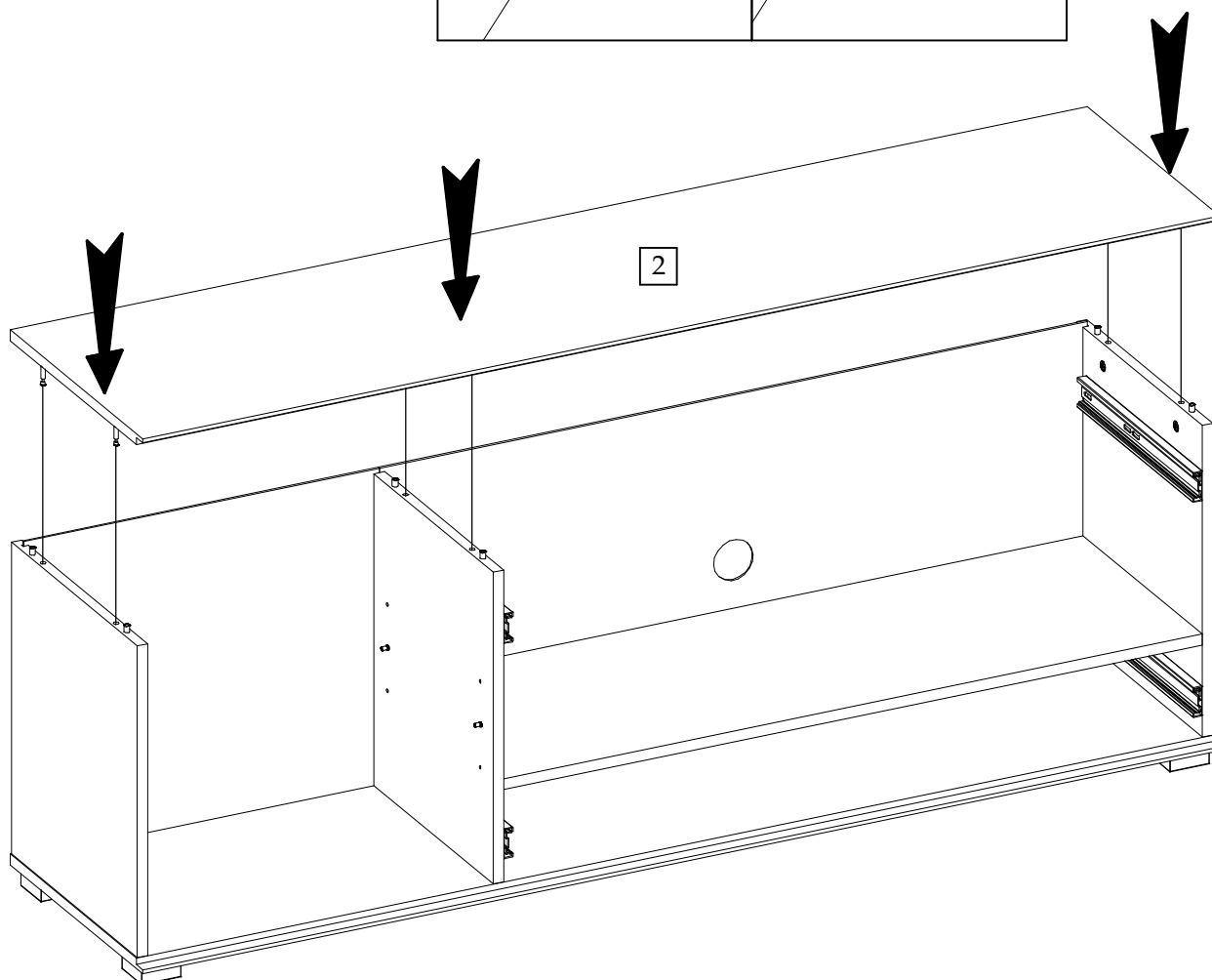

8

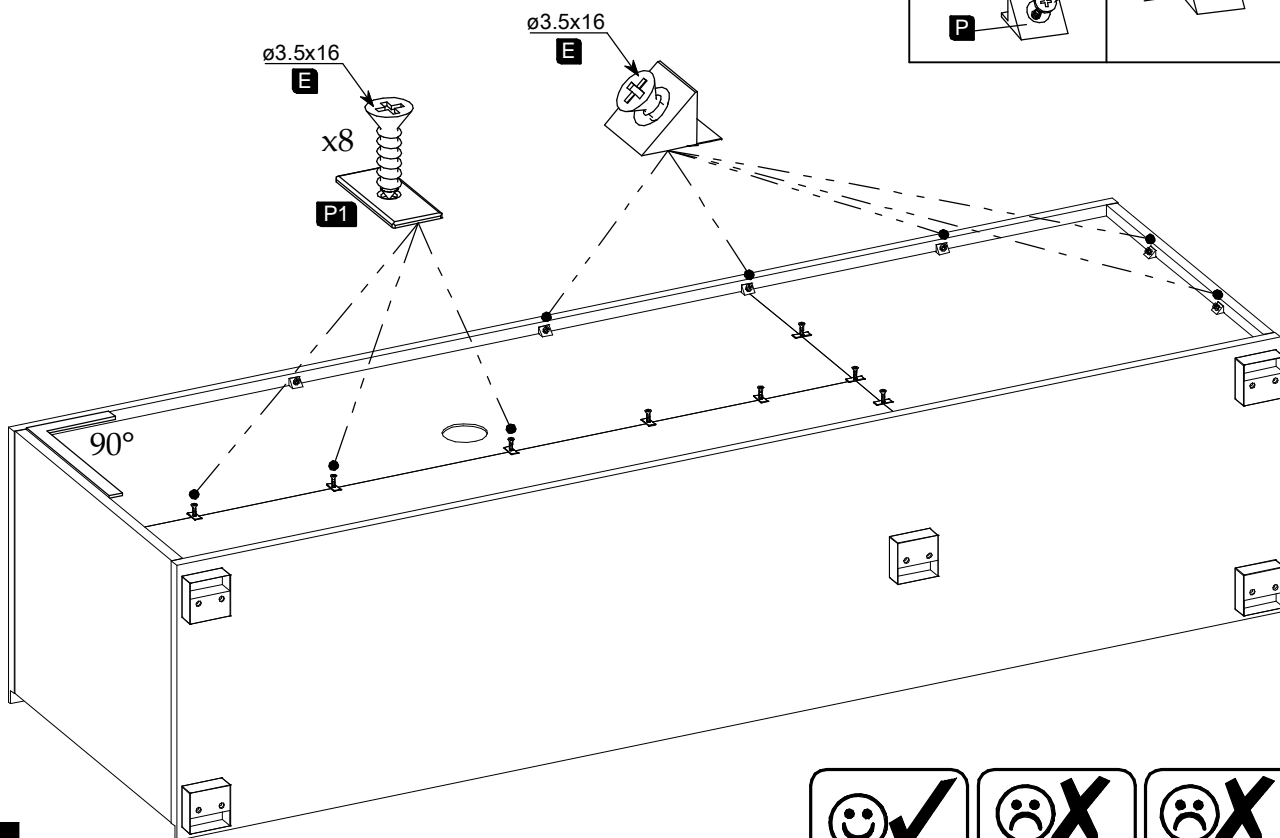
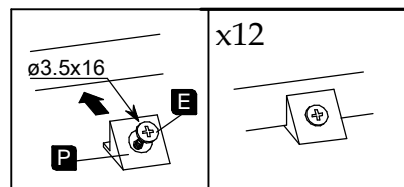

8

