

# DELI

## Typ C2

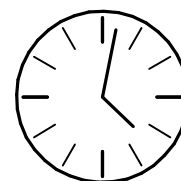

70 min

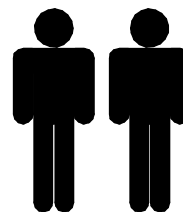
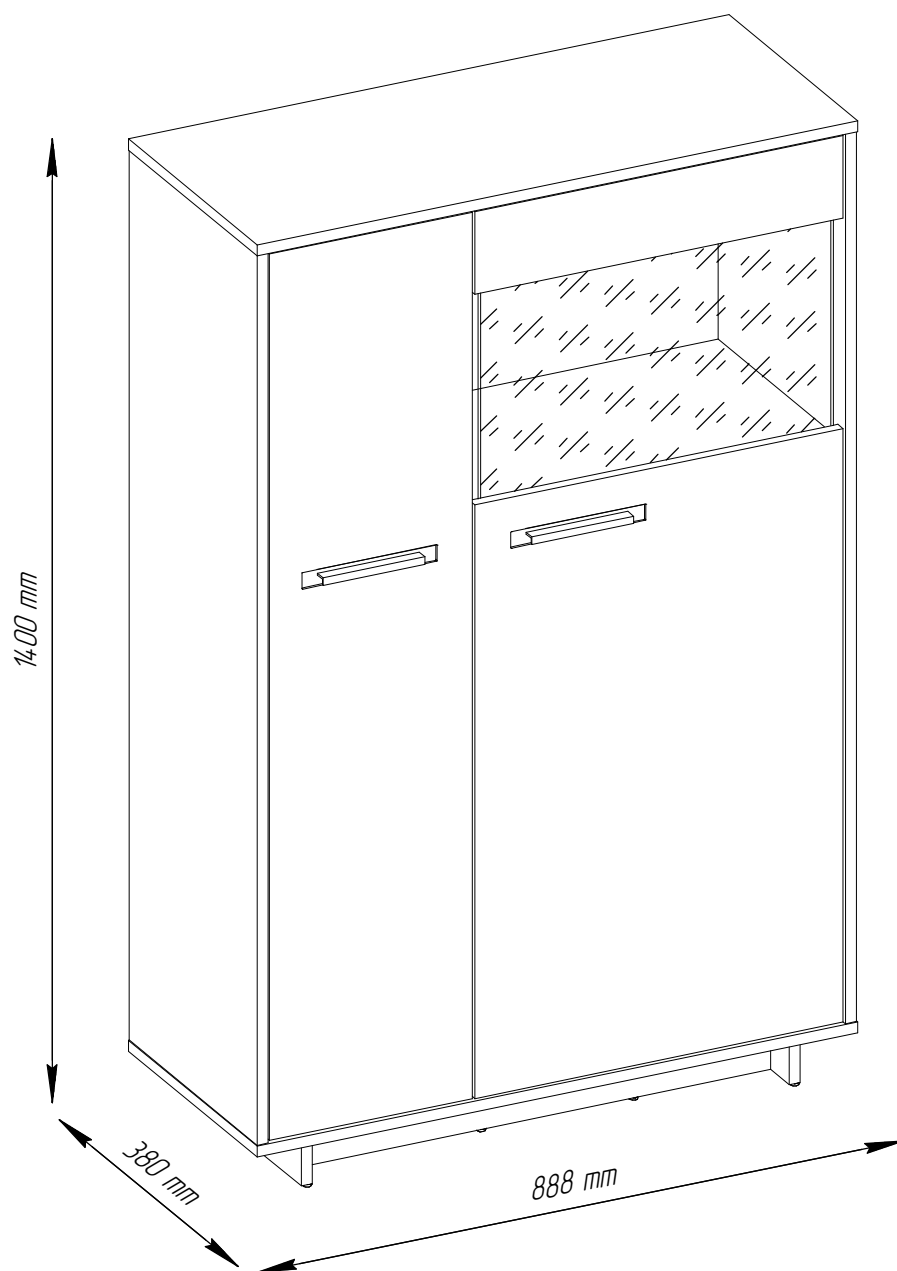

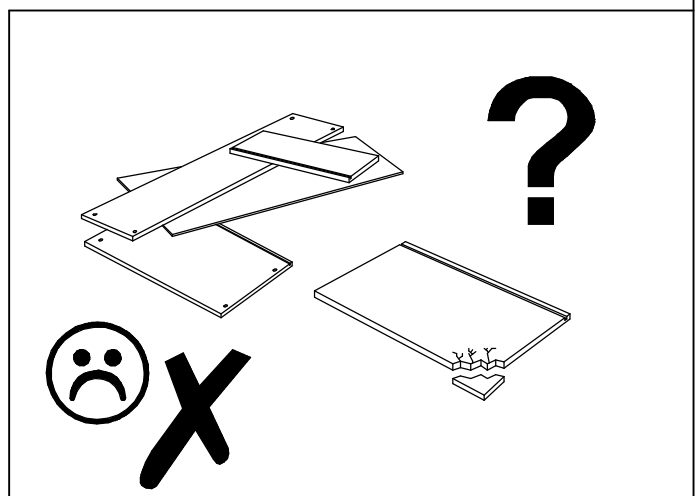
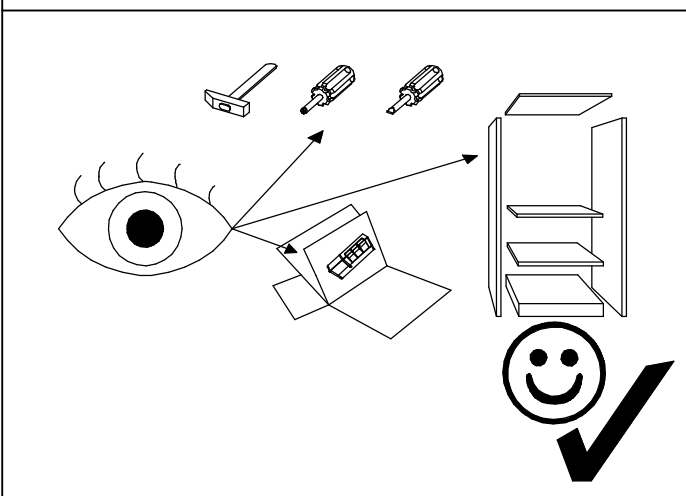
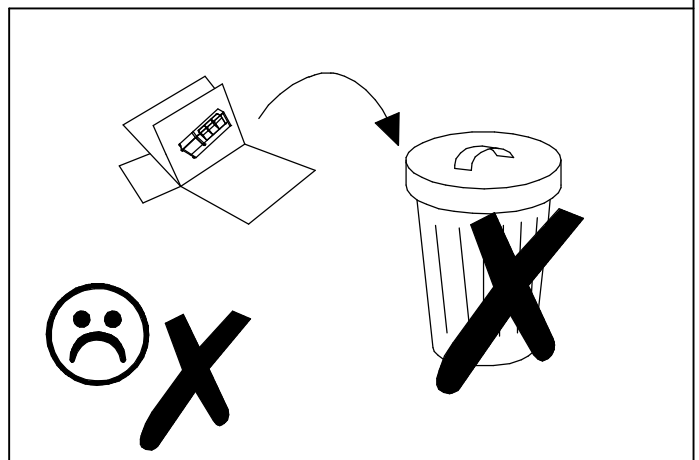
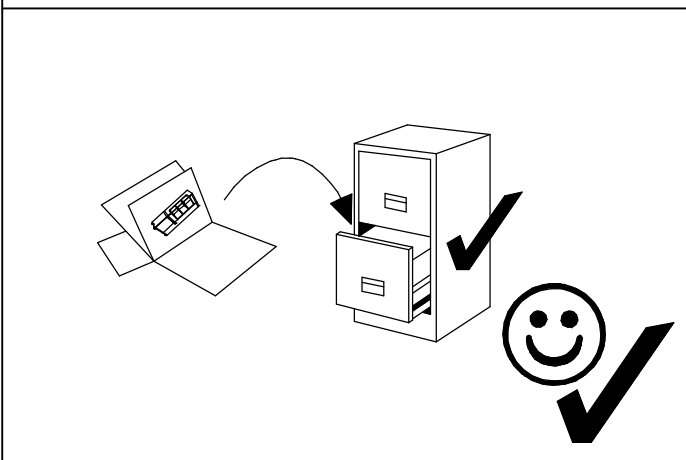
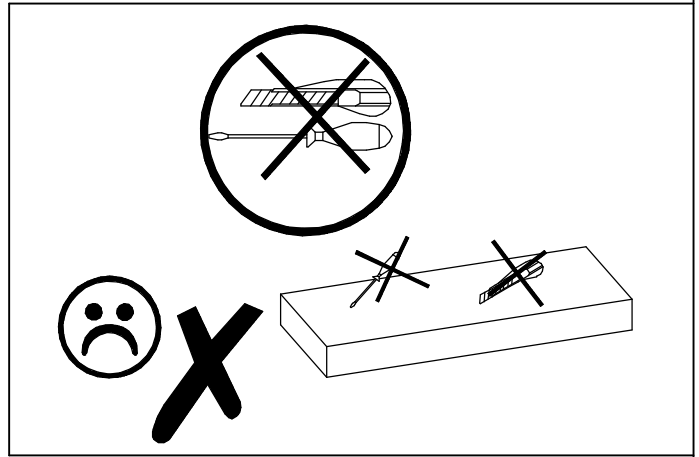
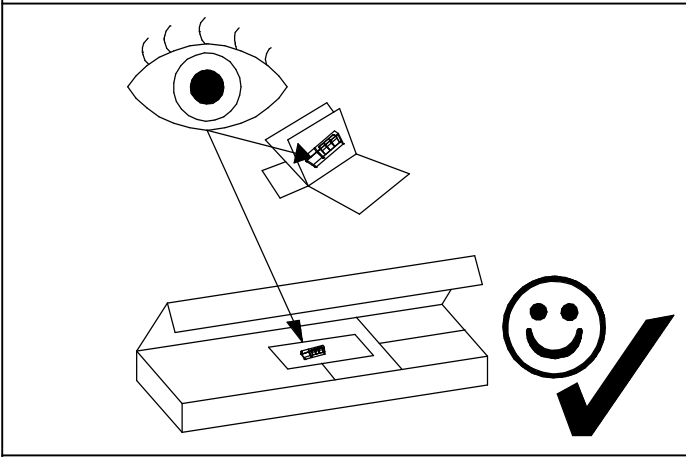

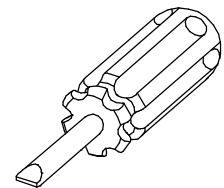
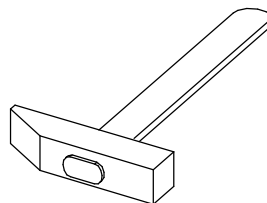
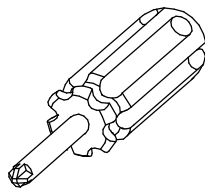
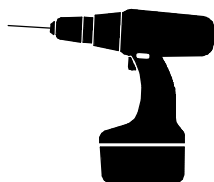
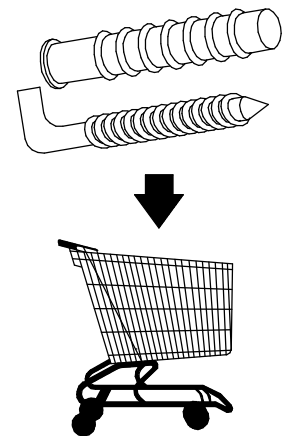
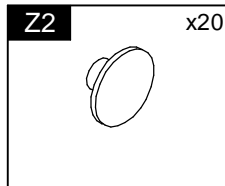
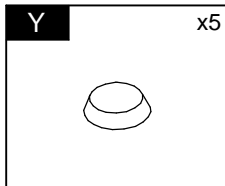
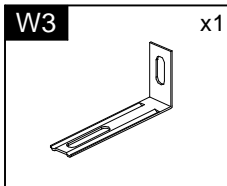
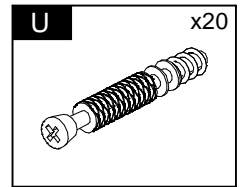
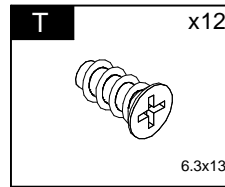
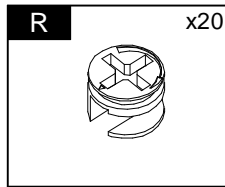
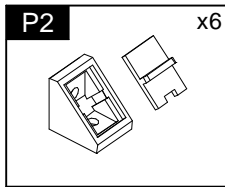
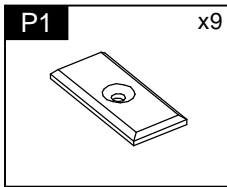
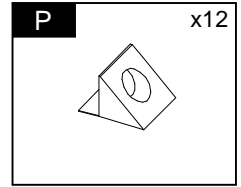
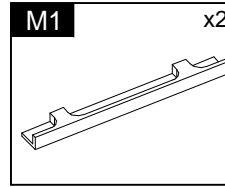
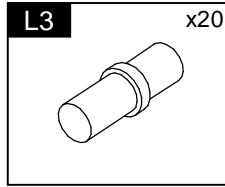
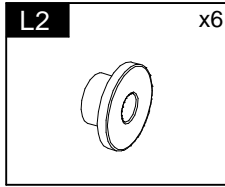
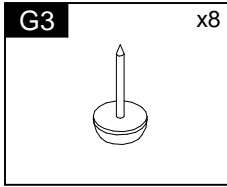
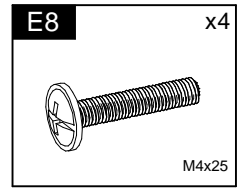
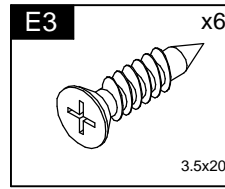
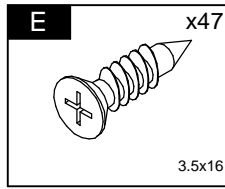
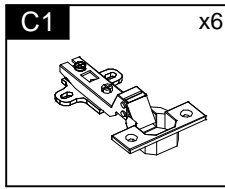
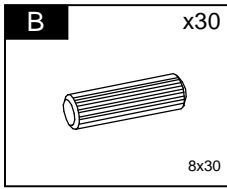
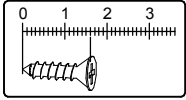
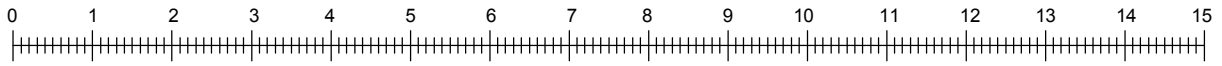

Element symbol	Measurements				Code	Paket
1	341	65	16	1	1001	1/4
2	706	65	16	2	1002	1/4
3	341	65	16	1	1003	1/4
4	888	380	16	1	1005	1/4
5	888	380	16	1	1006	1/4
6	1293	378	16	1	1007	2/4
7	1293	378	16	1	1008	2/4
8	1293	341	16	1	1009	2/4
9	541	331	16	1	1011	1/4
10	541	330	16	2	N/A	1/4
11	296	330	16	3	N/A	1/4
12	457	556	3	1	1010	3/4
13	850	556	3	1	N\A	3/4
14	1307	311	3	1	N\A	2/4
15	862	545	16	1	3005	3/4
16	545	120	16	1	3006	3/4
17	1288	300	16	1	3007	2/4
18	536	370	4	1	GLASS	4/4

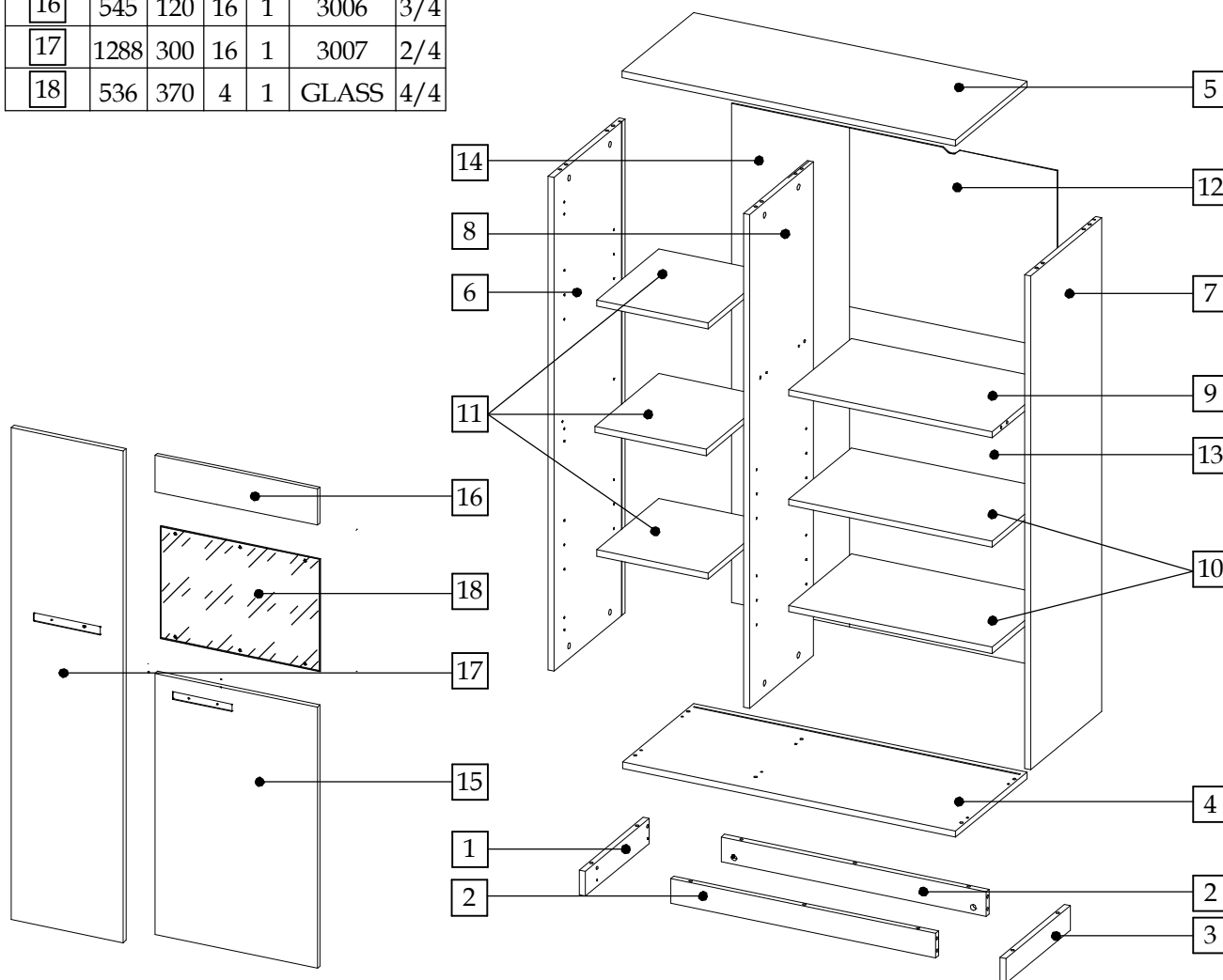
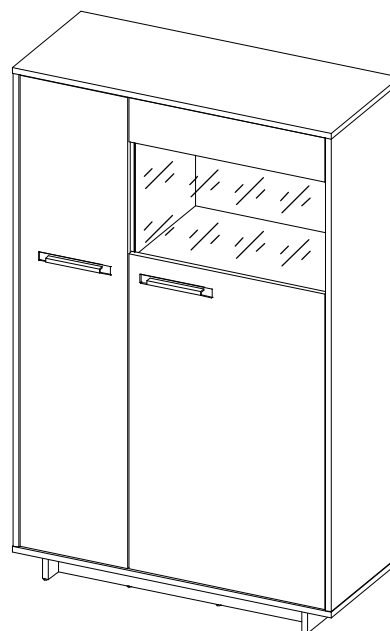

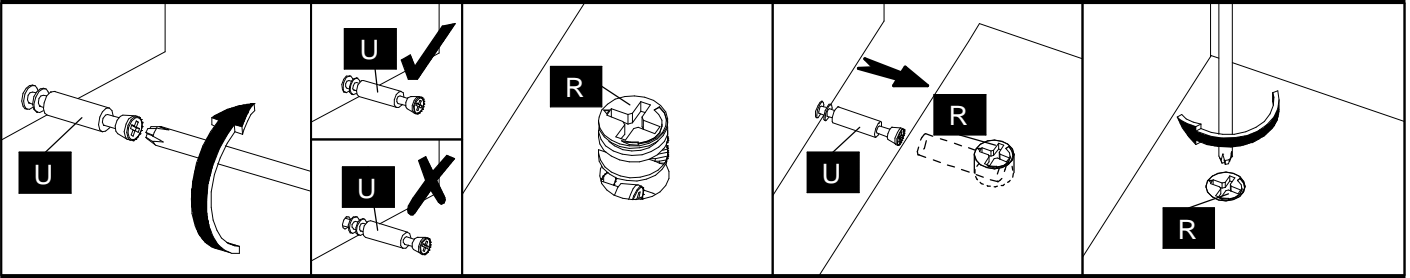

1

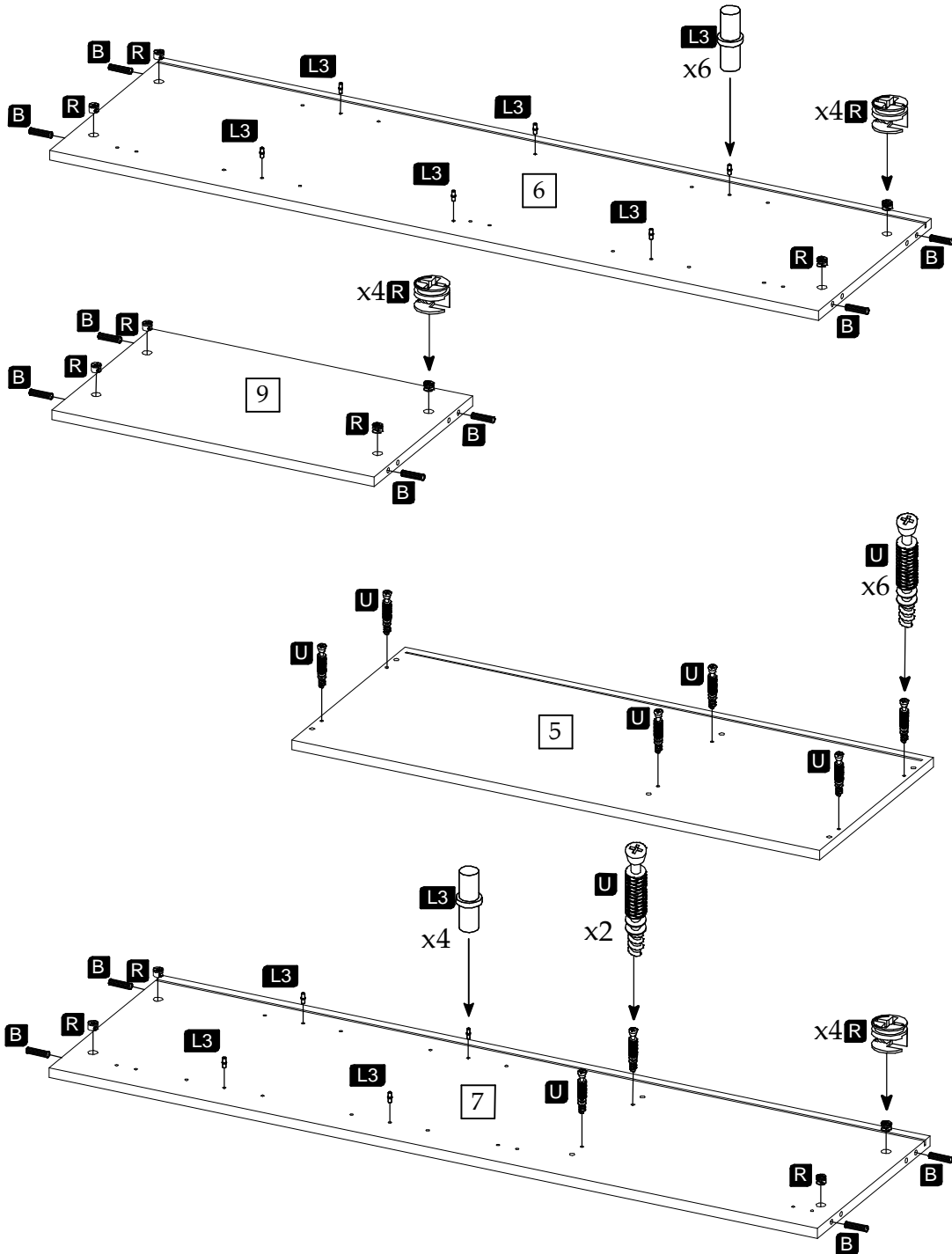

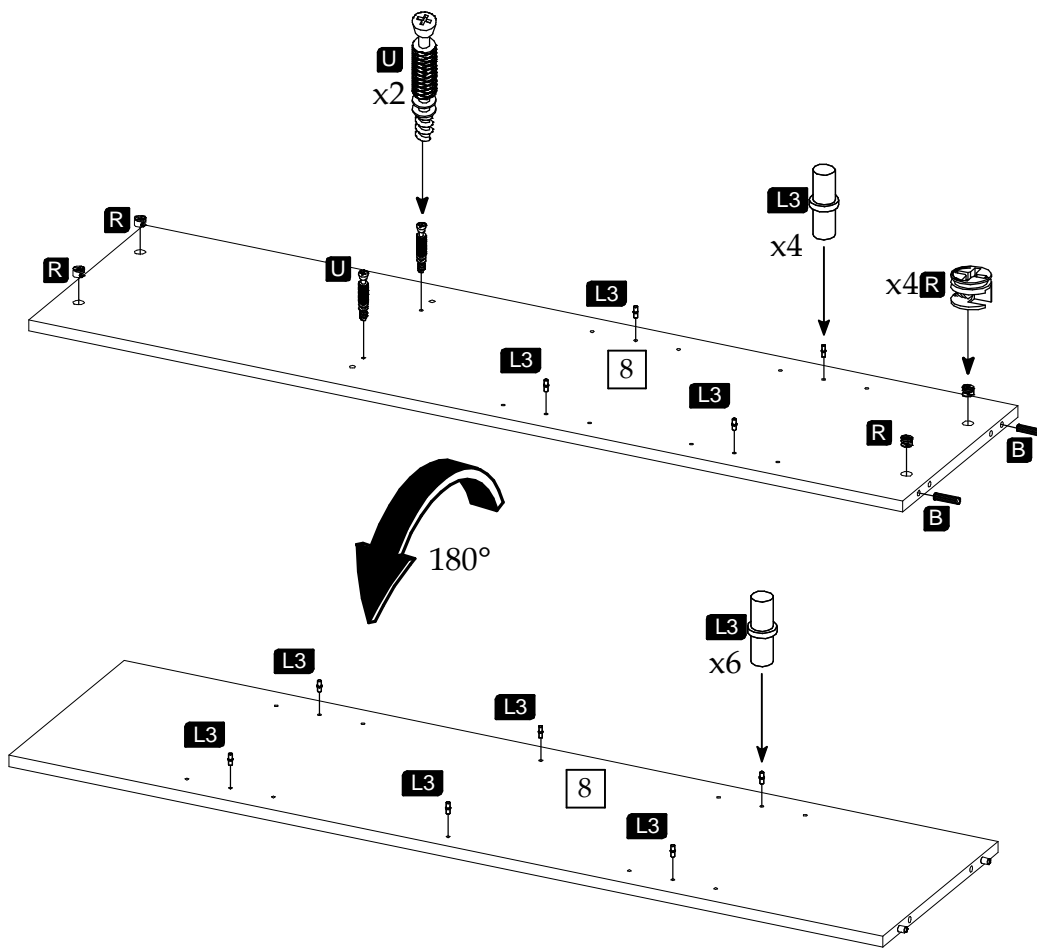

**2**

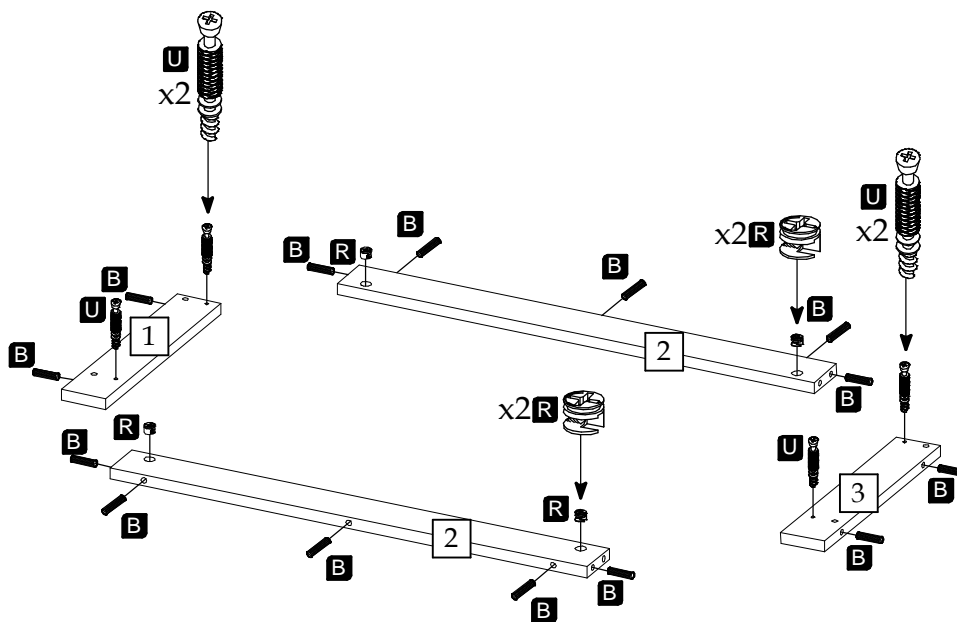

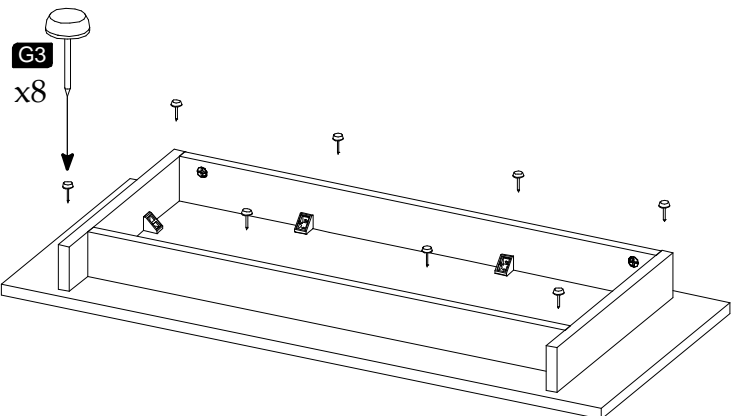
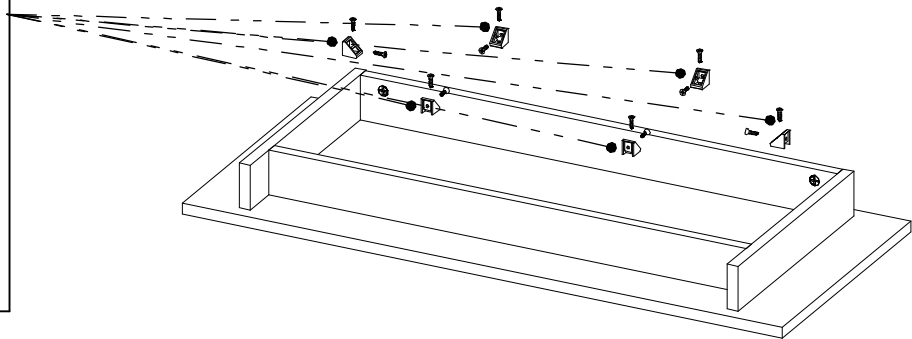
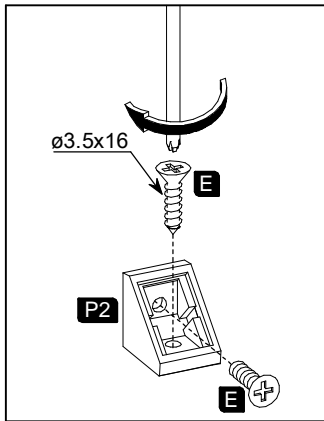
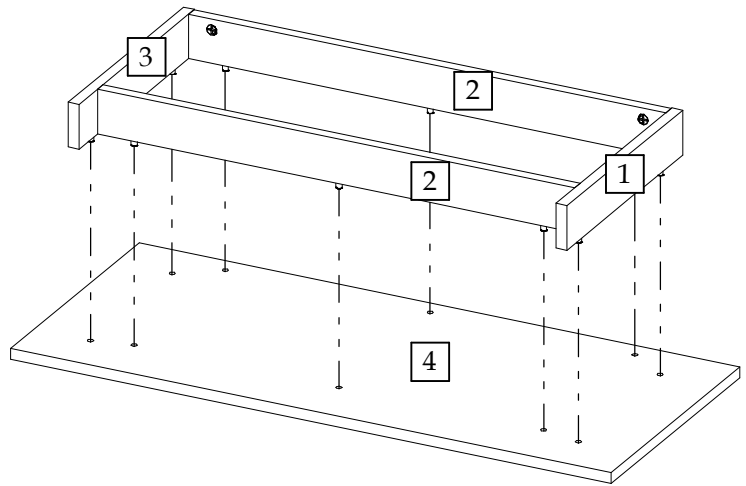
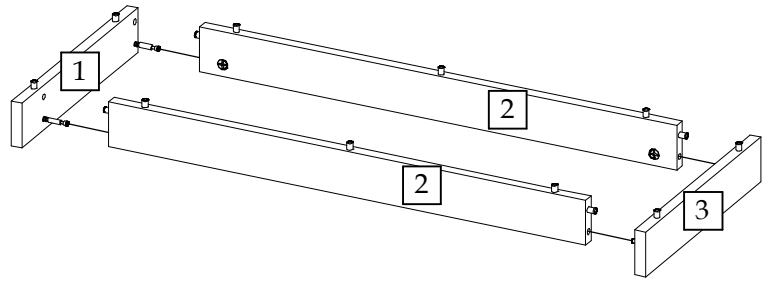
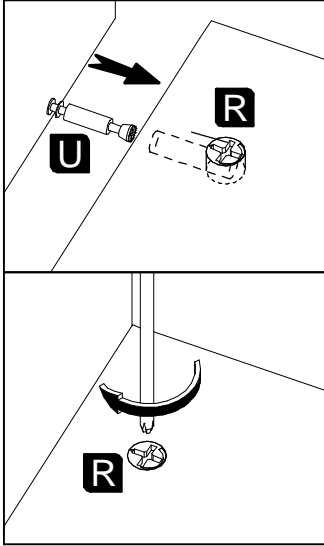

3

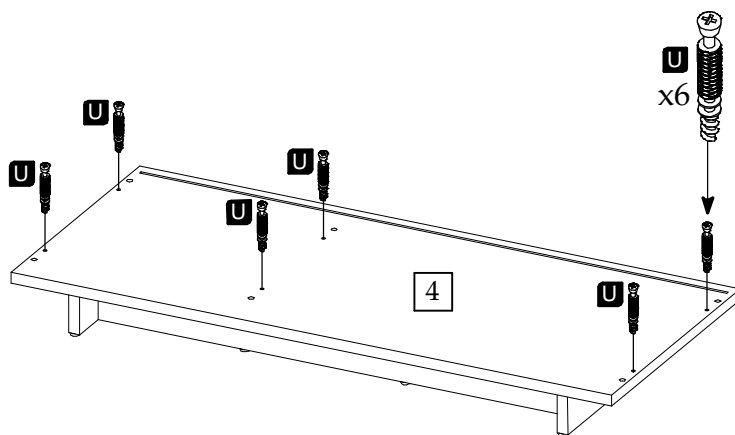

4

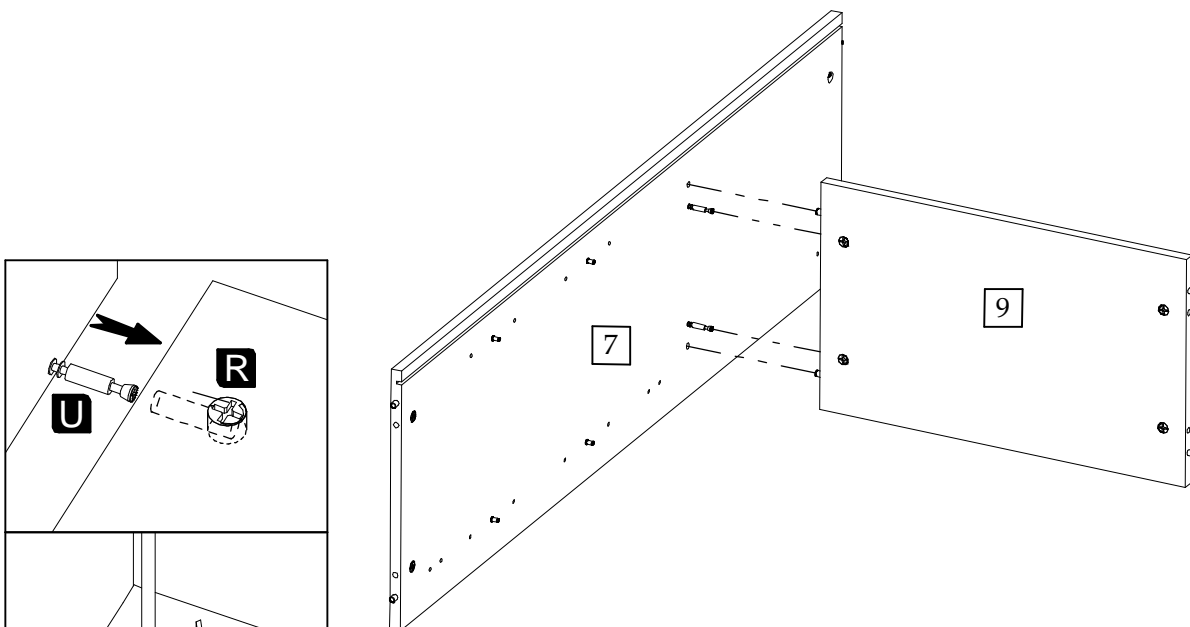

5

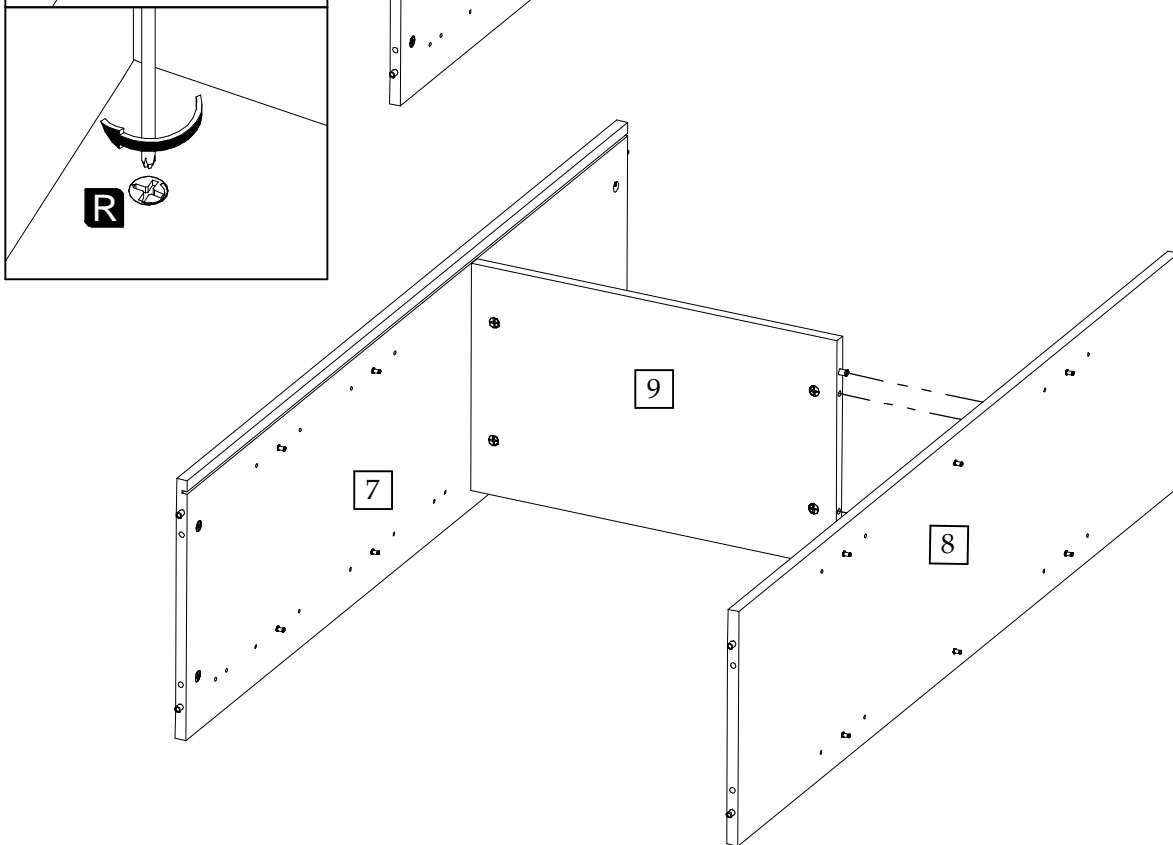



6

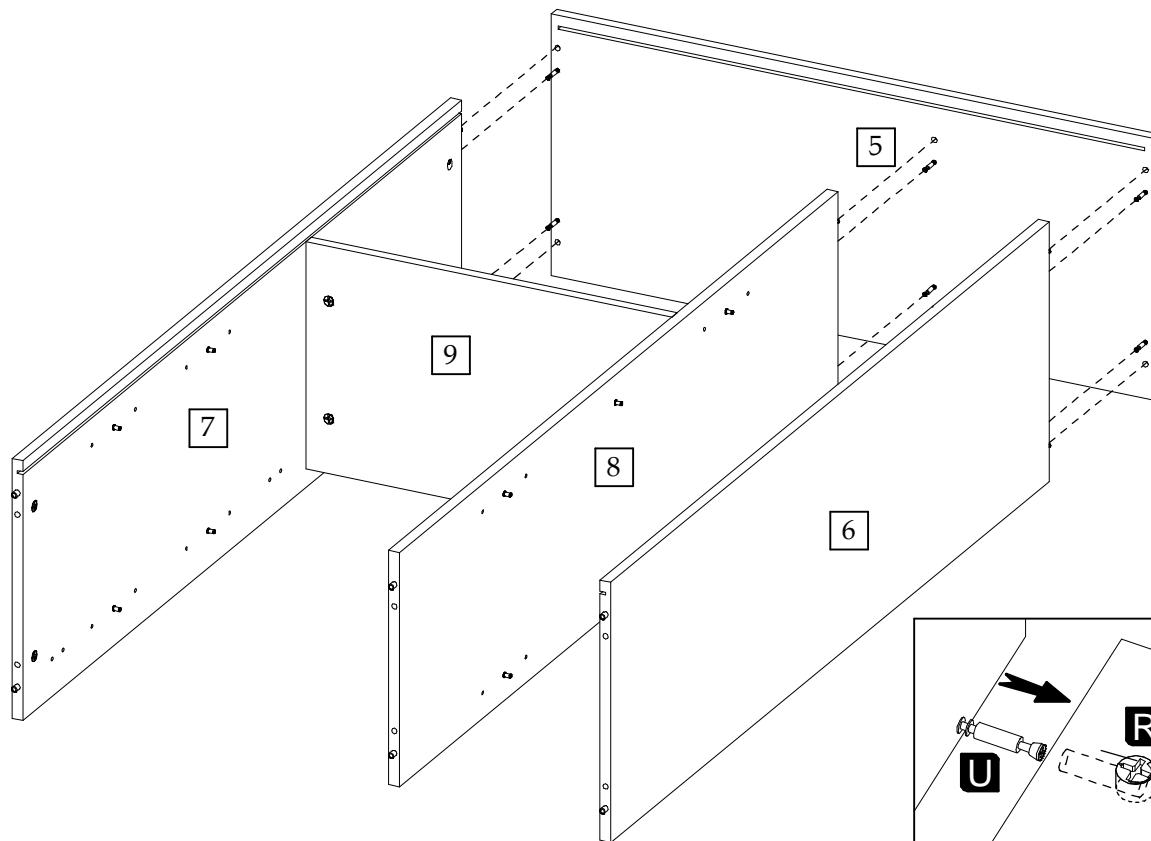

7

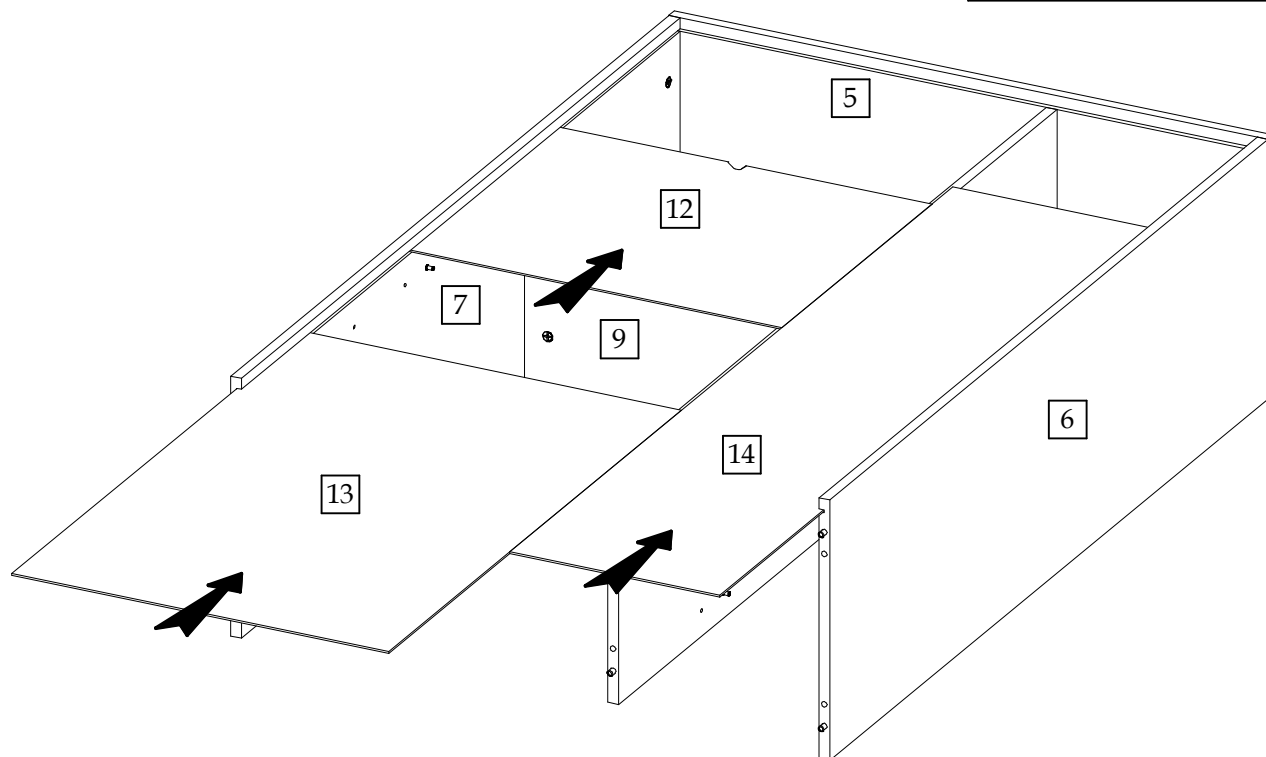
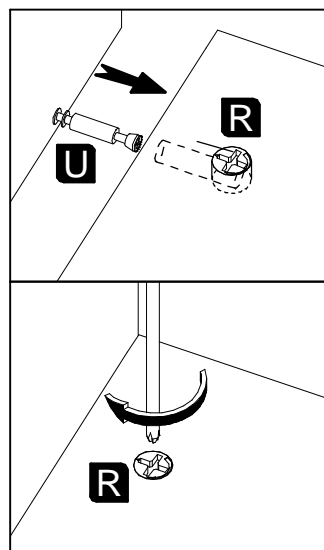

8

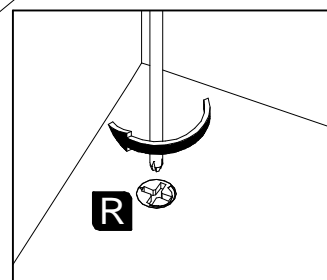
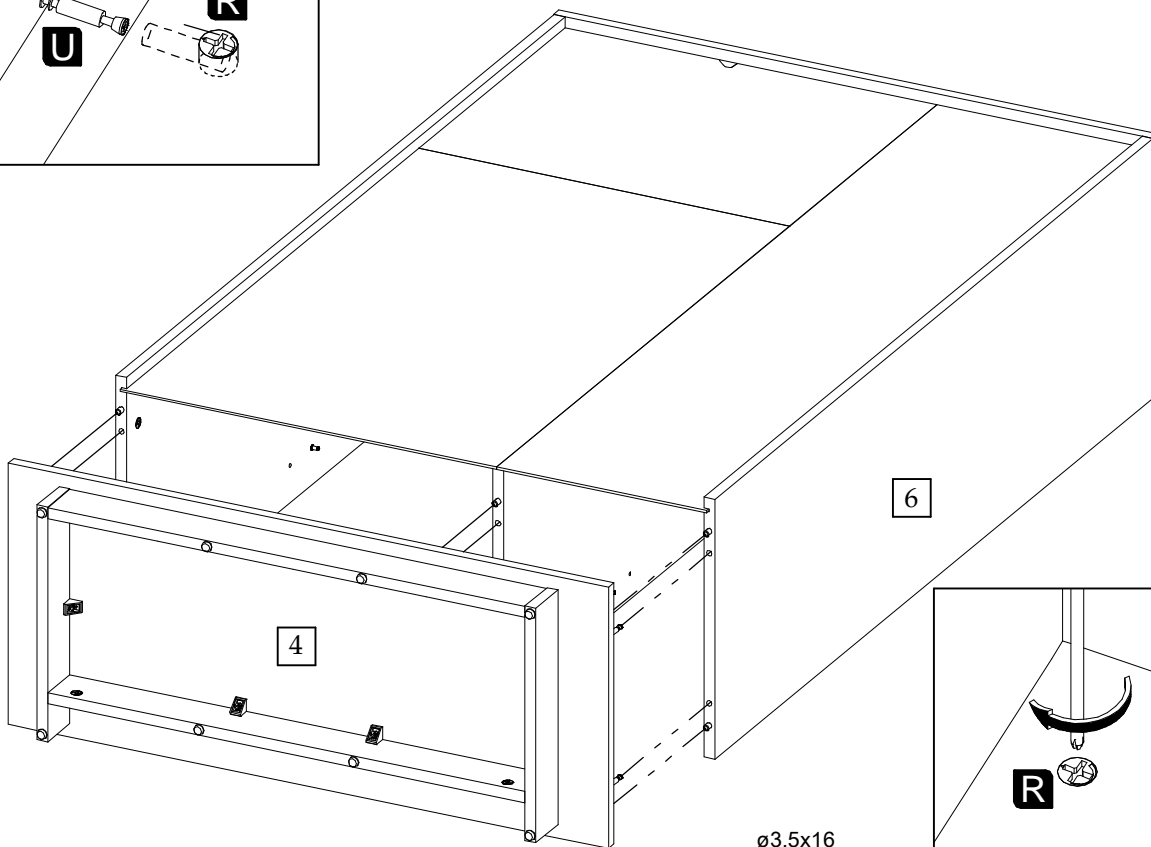
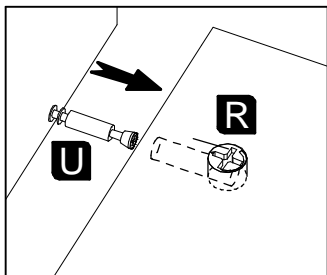

9

