

DERBY 2 C

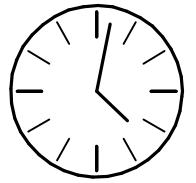

100 min

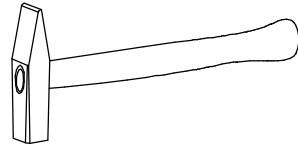

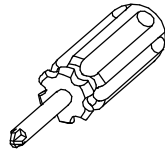
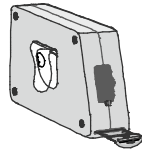
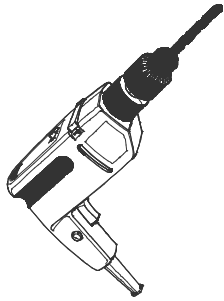
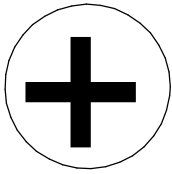
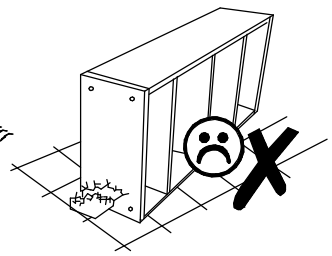
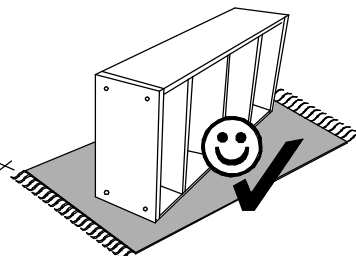
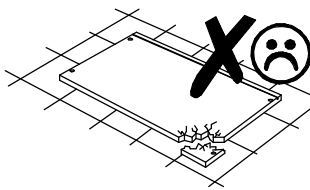
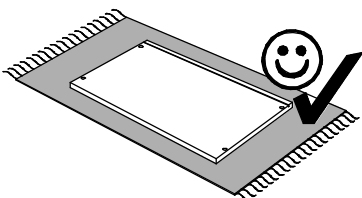
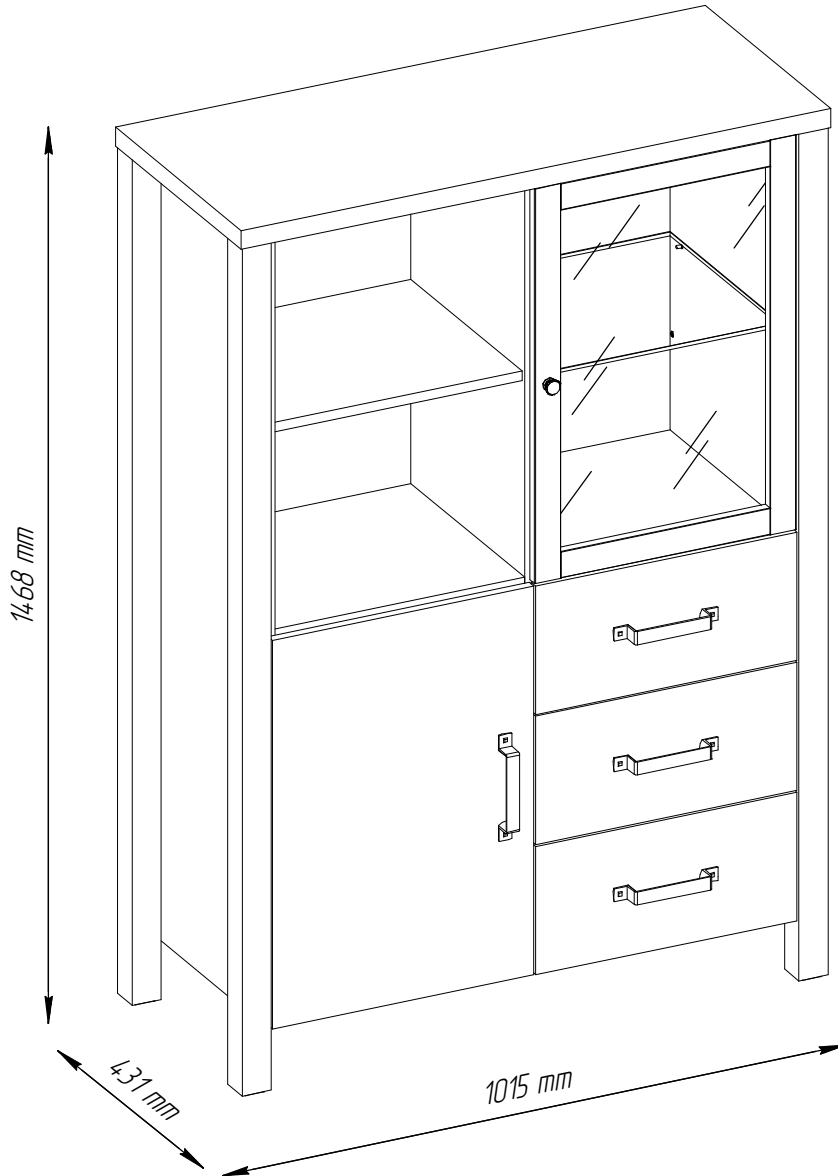
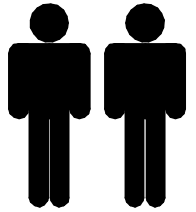
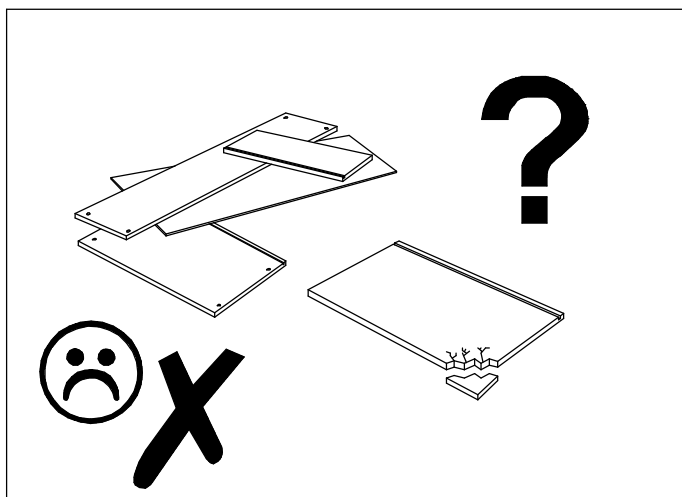
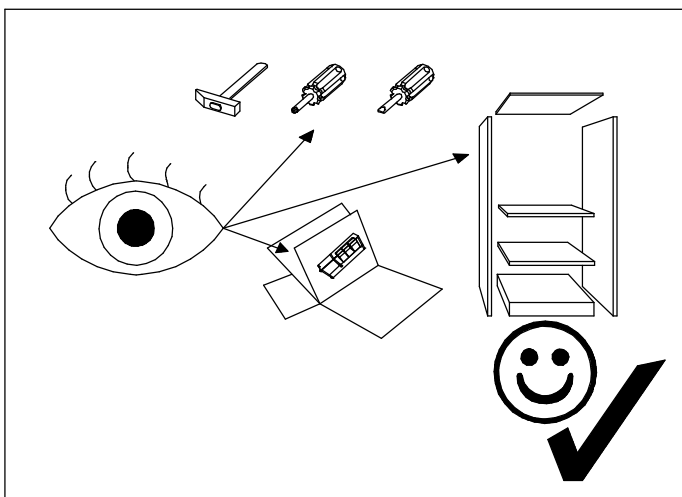
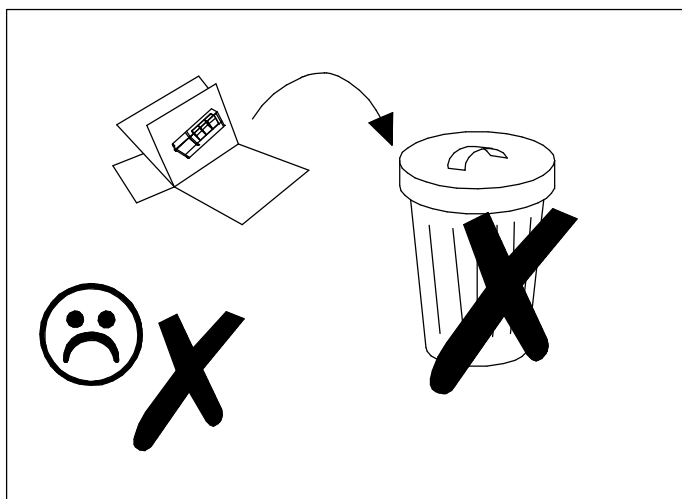
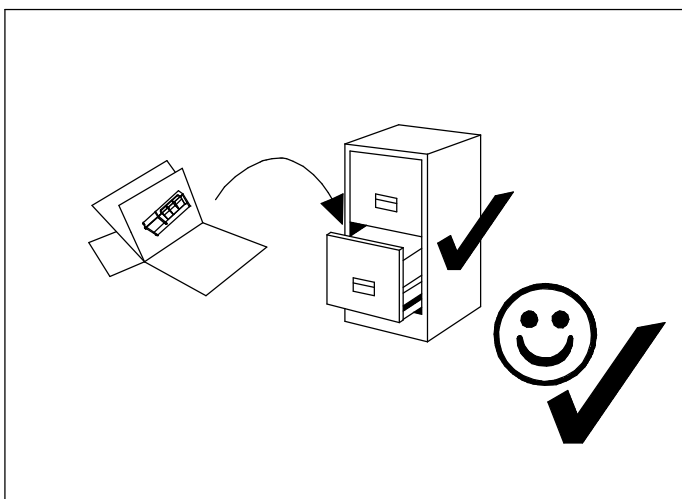
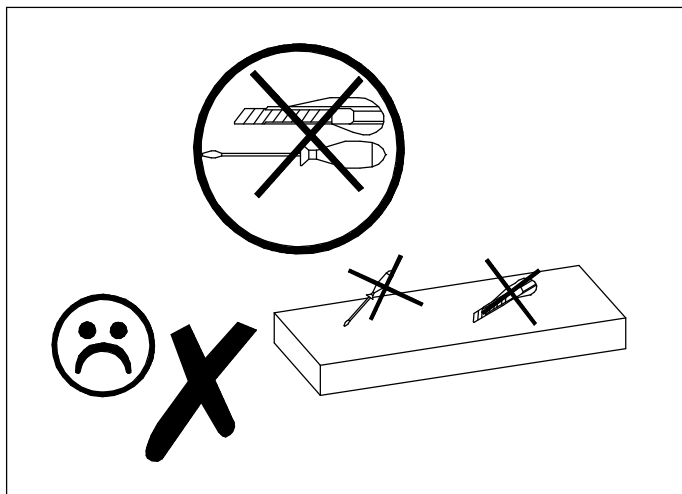
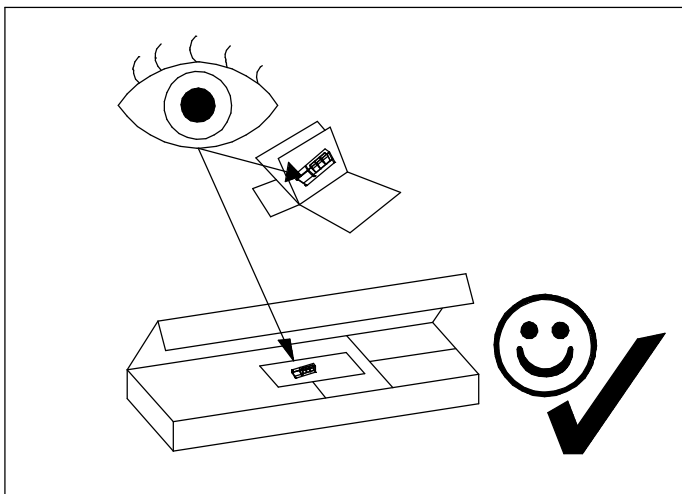

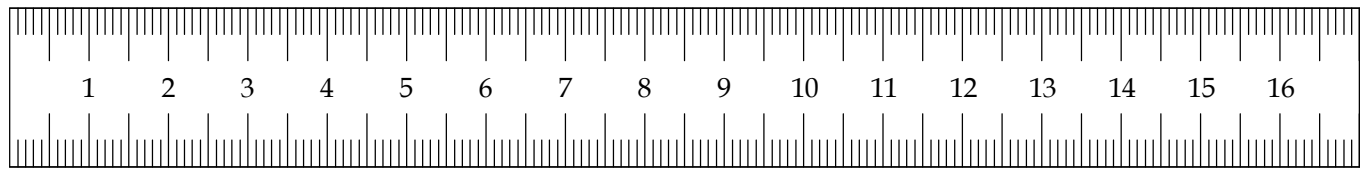
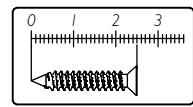
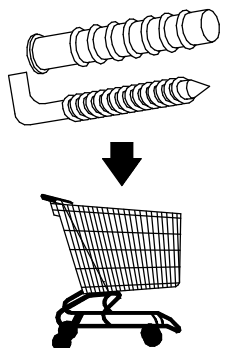
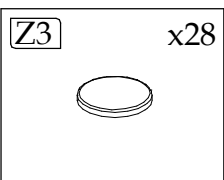
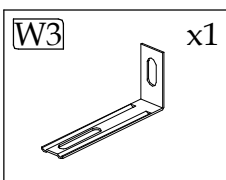
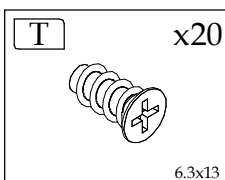
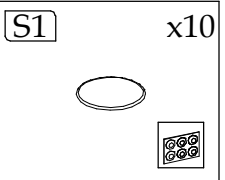
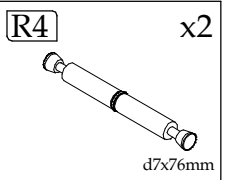
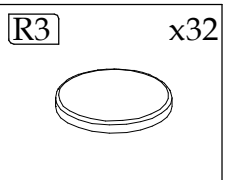
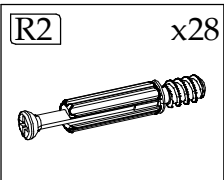
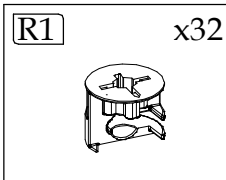
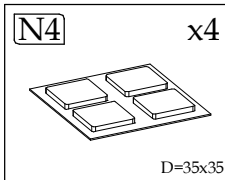
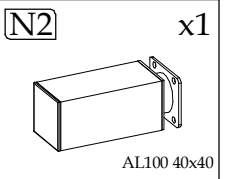
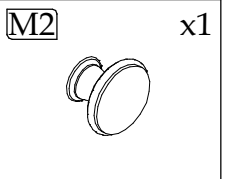
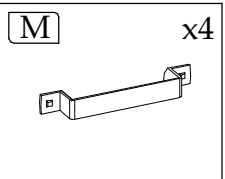
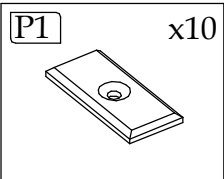
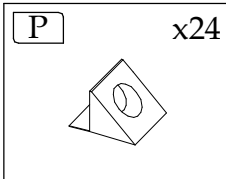
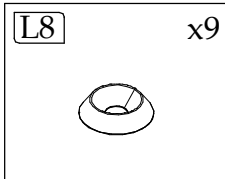
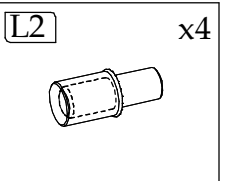
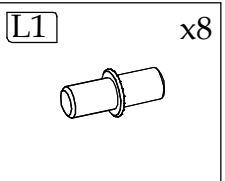
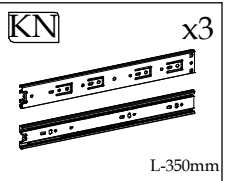
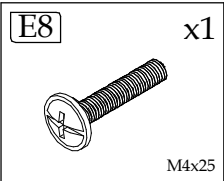
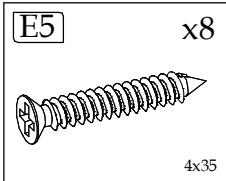
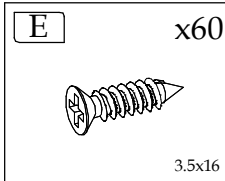
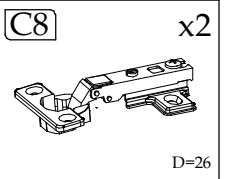
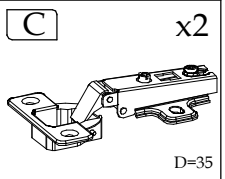
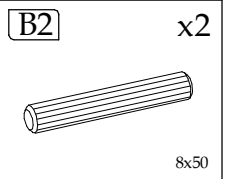
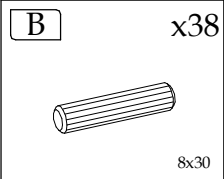
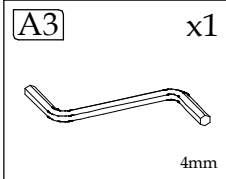
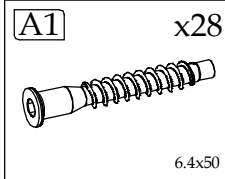

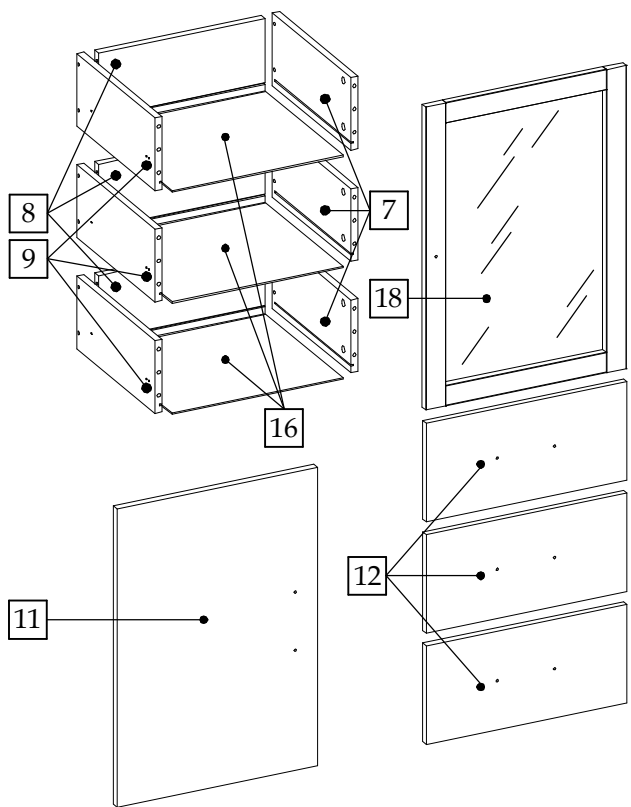

Element symbol	Measurements				Code	Pack
1	1015	431	32	1	1002	1/5
2	1334	410	16	1	1005	1/5
3	1334	410	16	1	1006	1/5
4	1317	390	16	1	1053	1/5
5	877	409	16	1	1007	1/5
6	430	390	16	2	1010-1016	1/5
7	350	160	16	3	1018-1023-1028	1/5
8	373	159	16	3	1019-1024-1029	1/5
9	350	160	16	3	1020-1025-1030	1/5
10	430	382	16	2	N/A	1-2/5
11	450	657	16	1	1012	2/5
12	450	217	16	3	1017-1022-1027	2/5
13	445	695	3	1	1090_v	2/5
14	445	695	3	1	1091_v	2/5
15	445	651	3	2	N/A	2/5
16	383	344	3	3	N/A	1/5
17	1433	50	50	4	1433x50_u	3/5
18	668	450	16	1	Glass door	4/5
19	429	380	6	1	Glass shelf	5/5

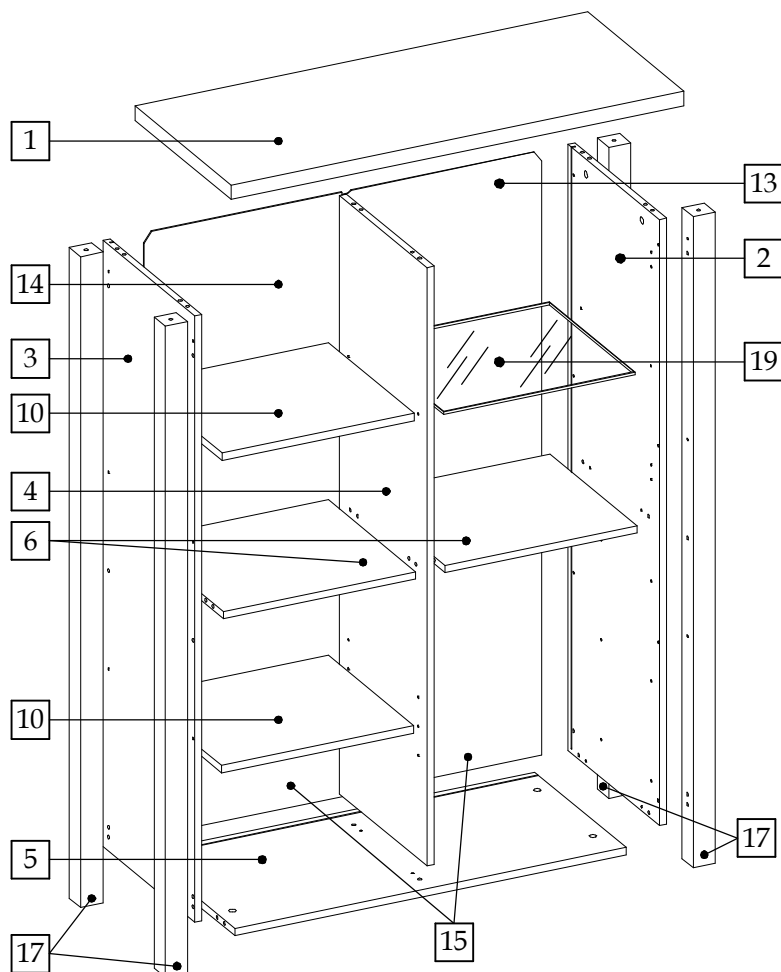

2

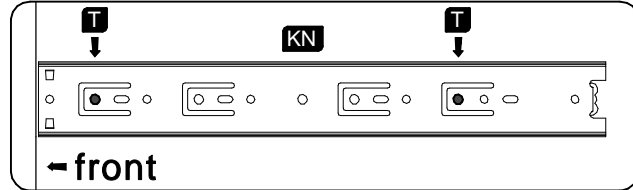
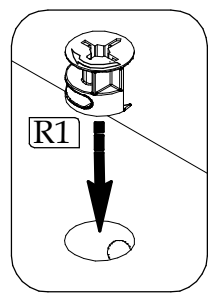
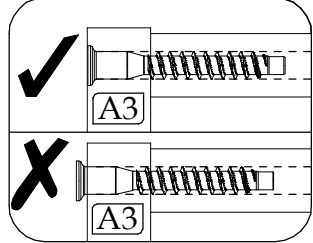
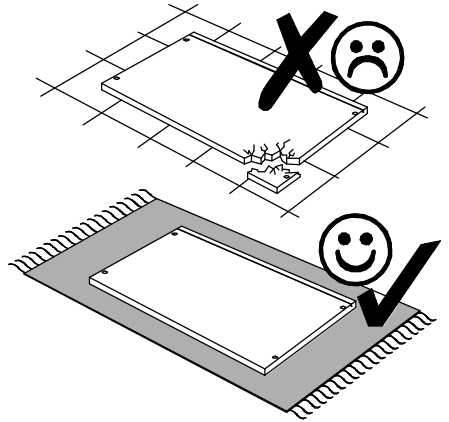
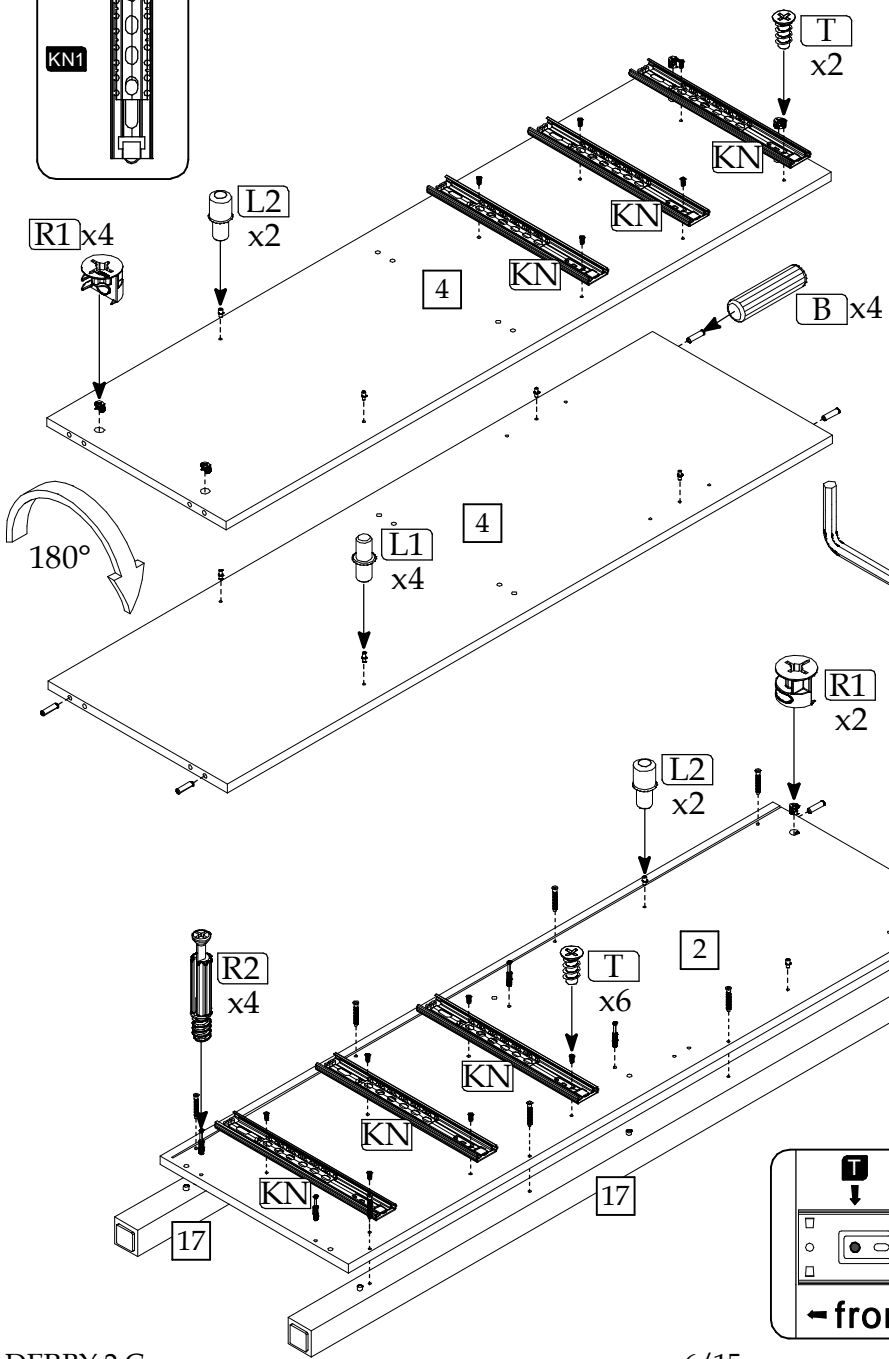
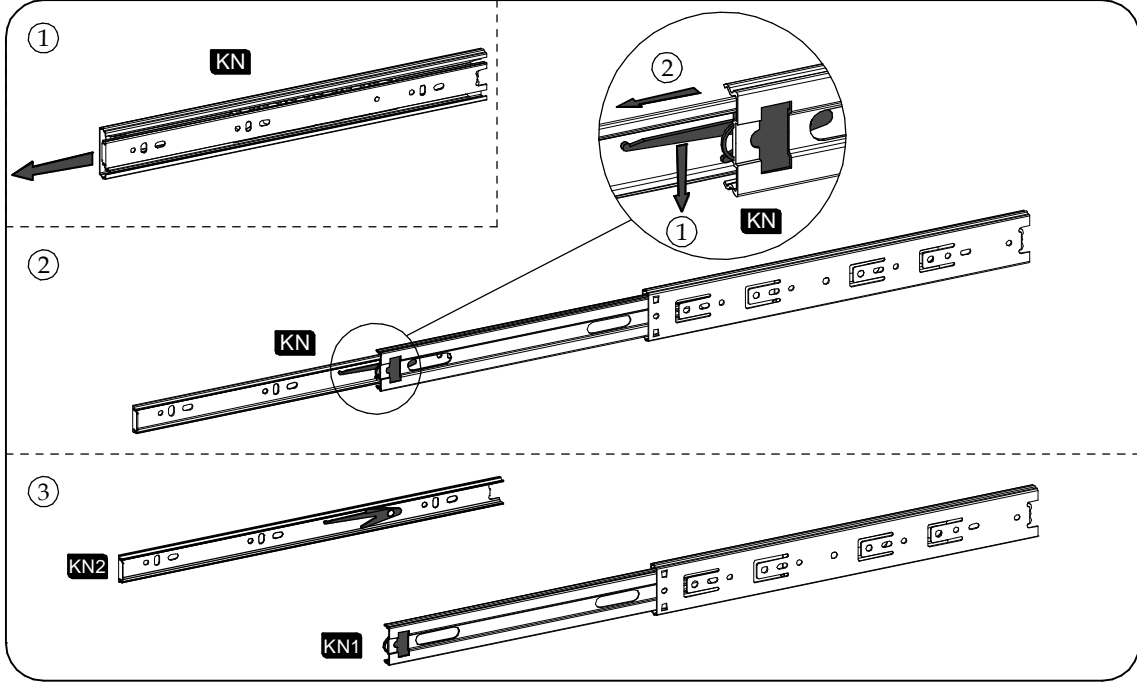
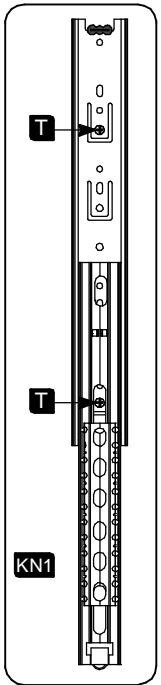

▶ 3

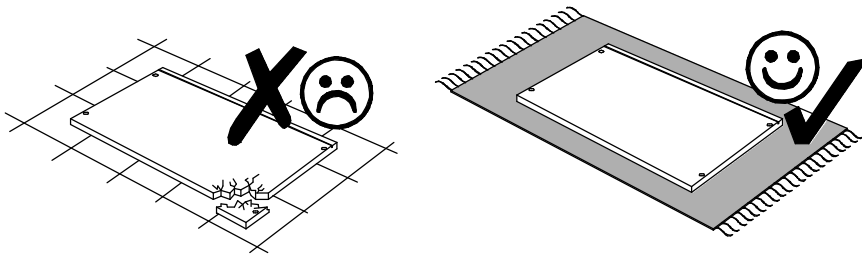
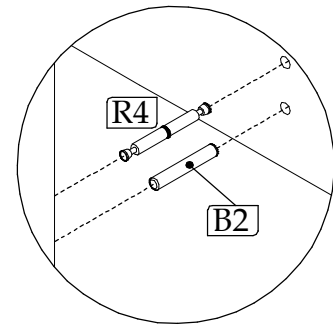
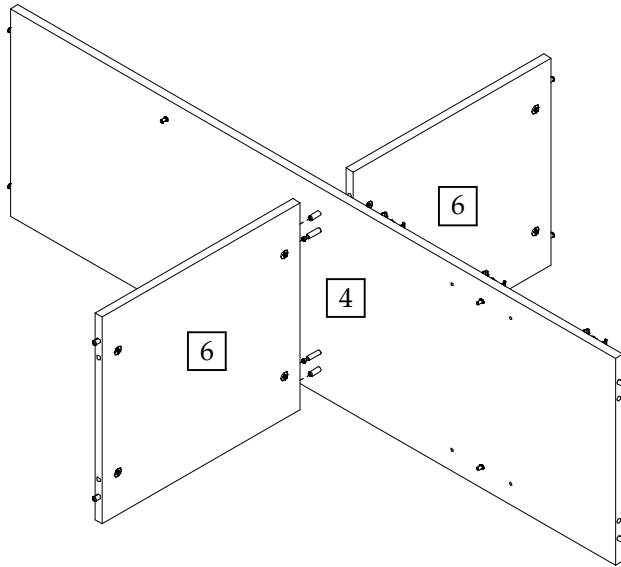

▶ 4

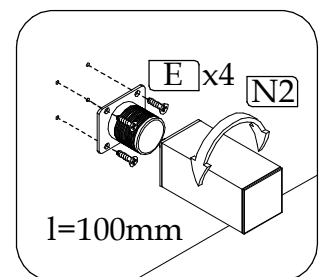
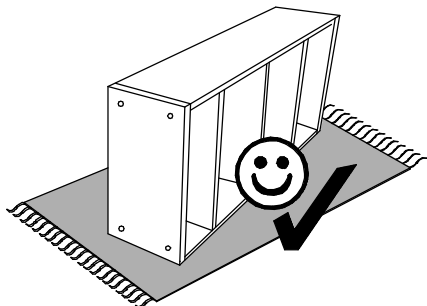
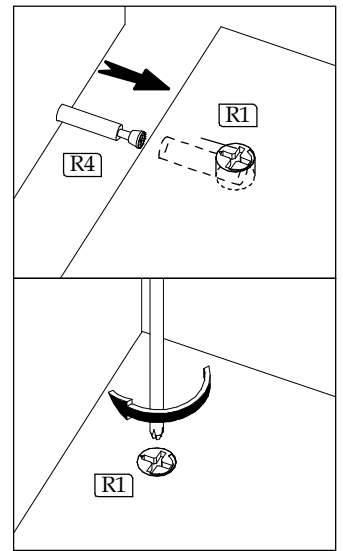
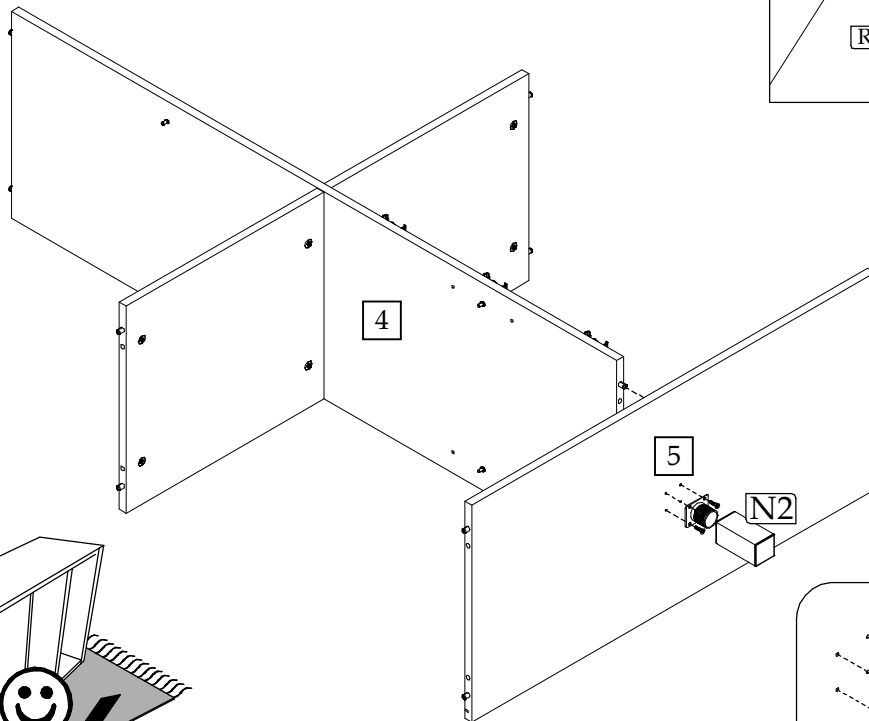

► 5

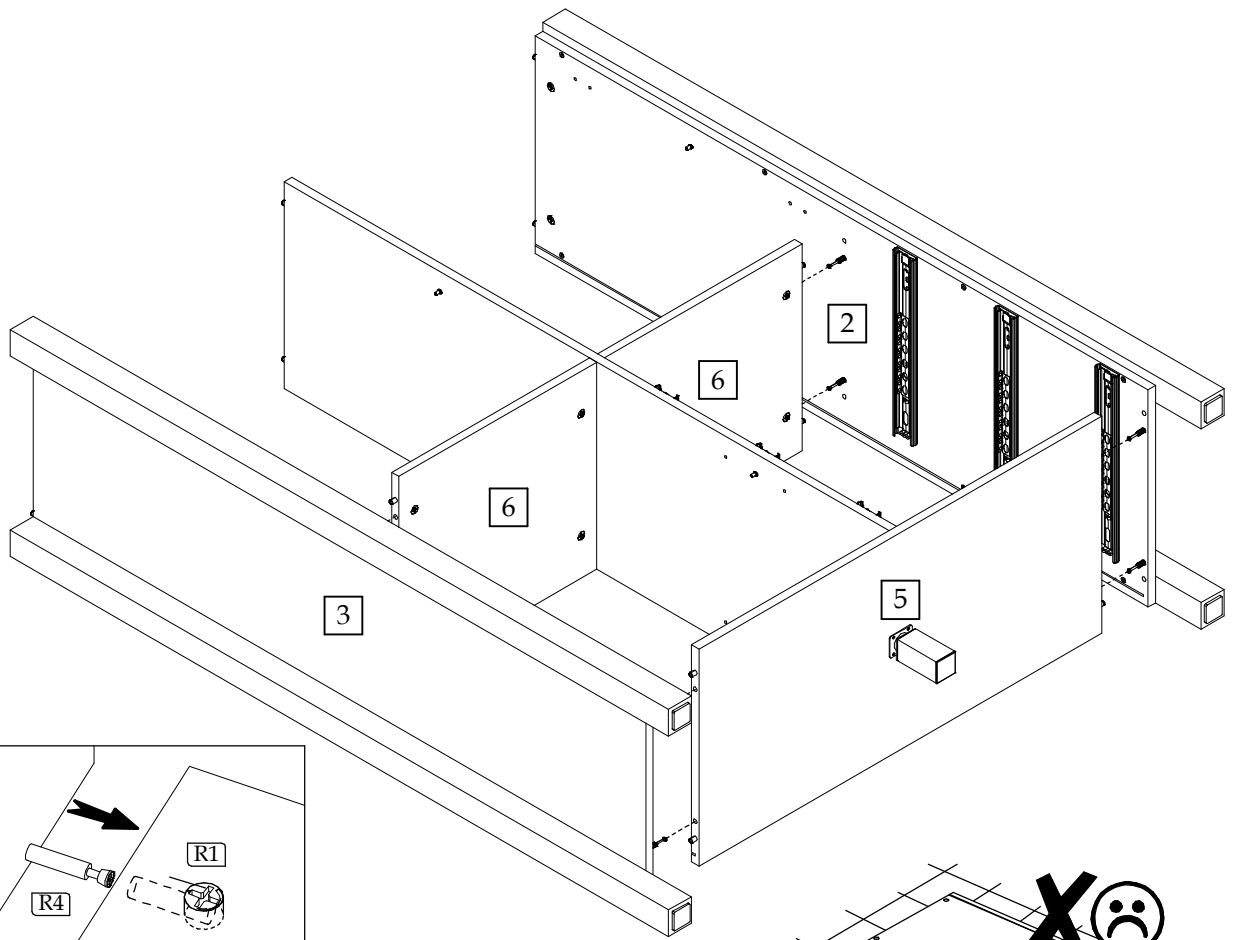

► 6

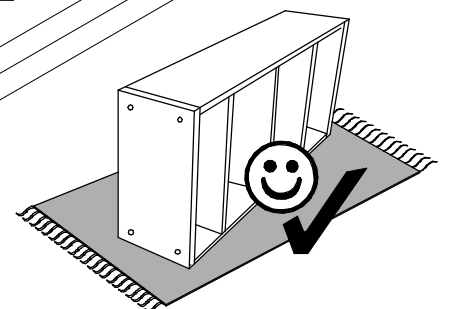
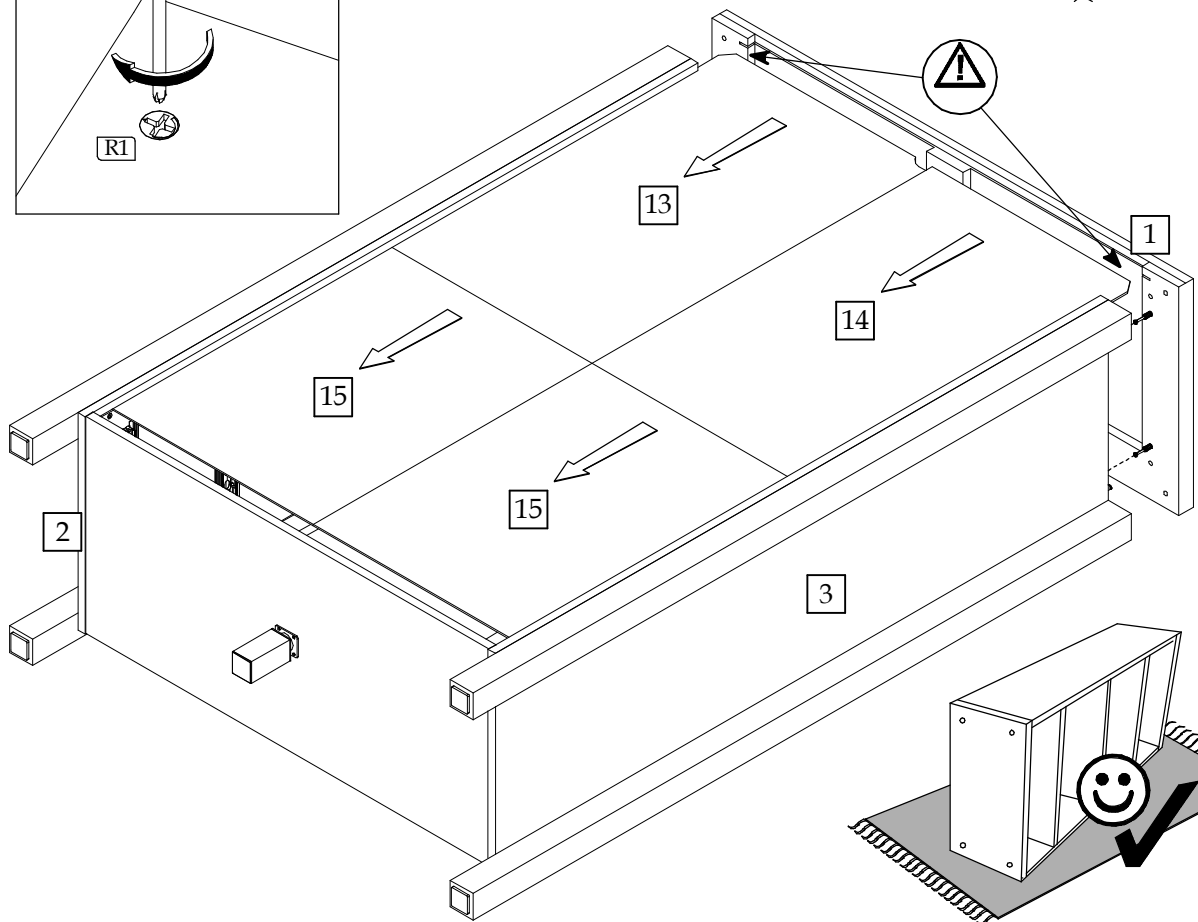
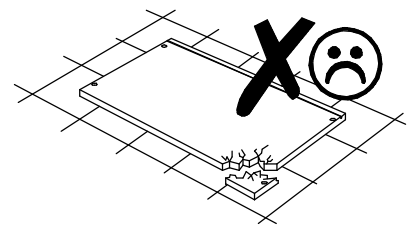
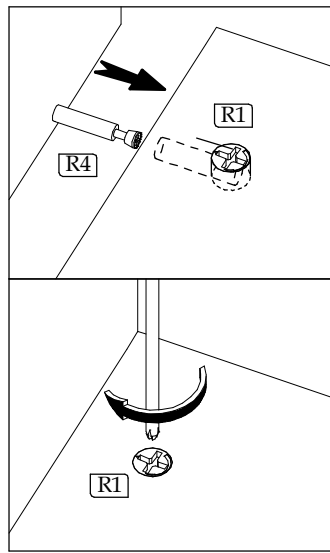

▶ 7

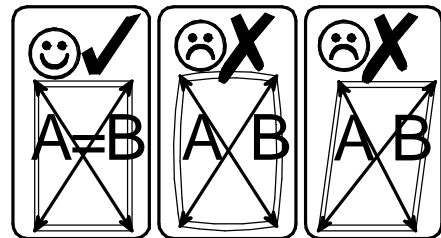
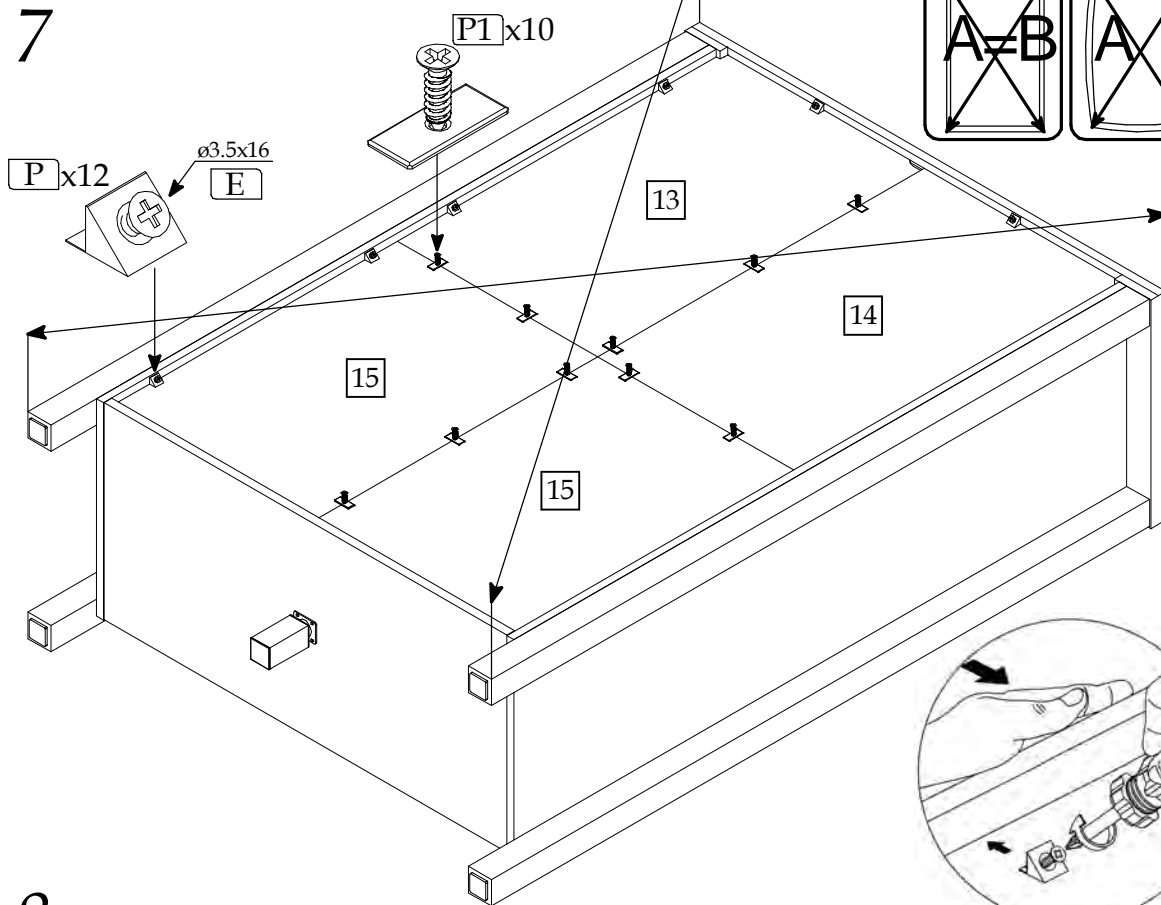

▶ 8

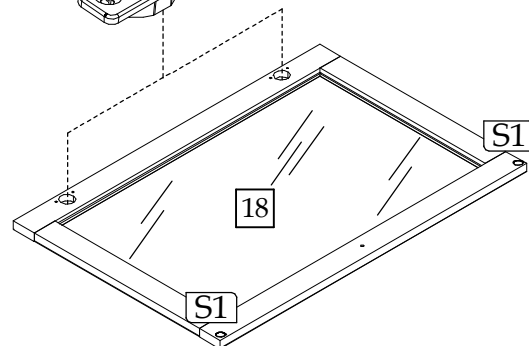
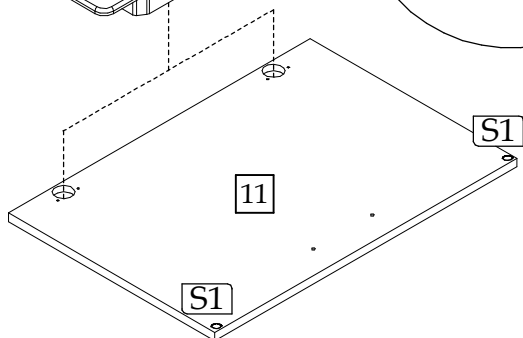
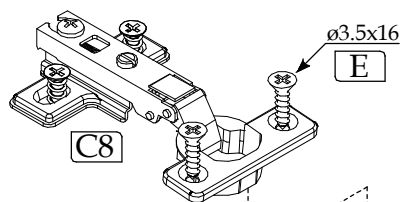
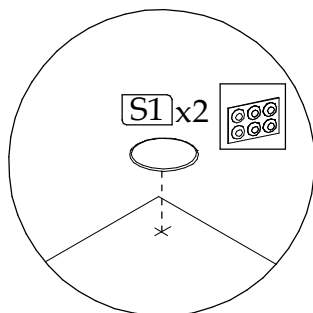
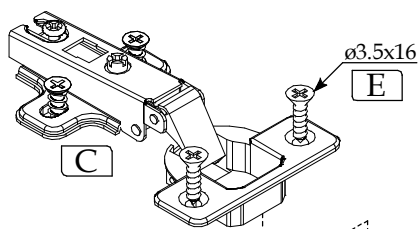
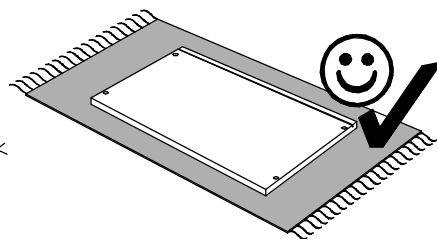
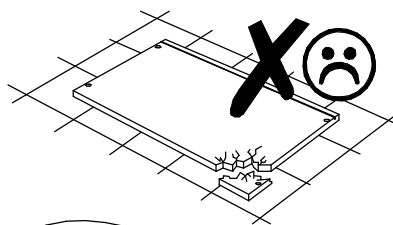

▶ 10

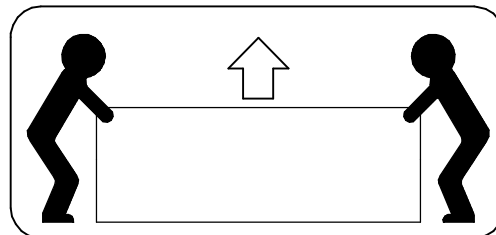
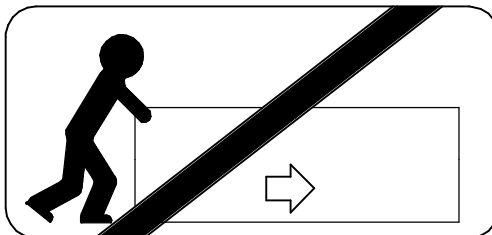
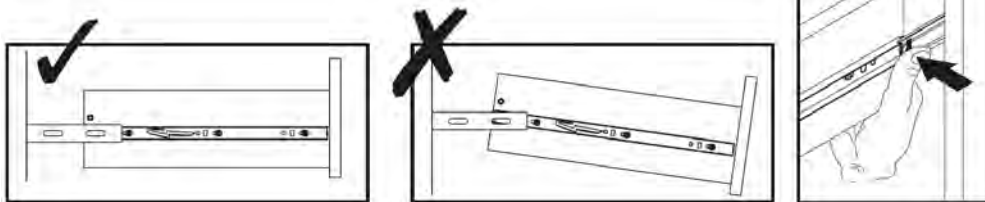
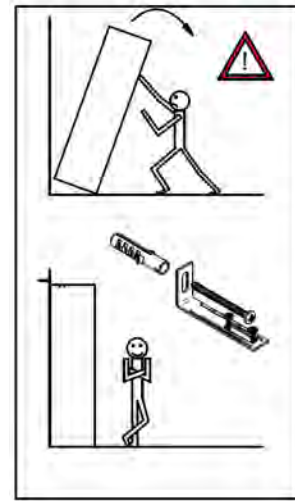
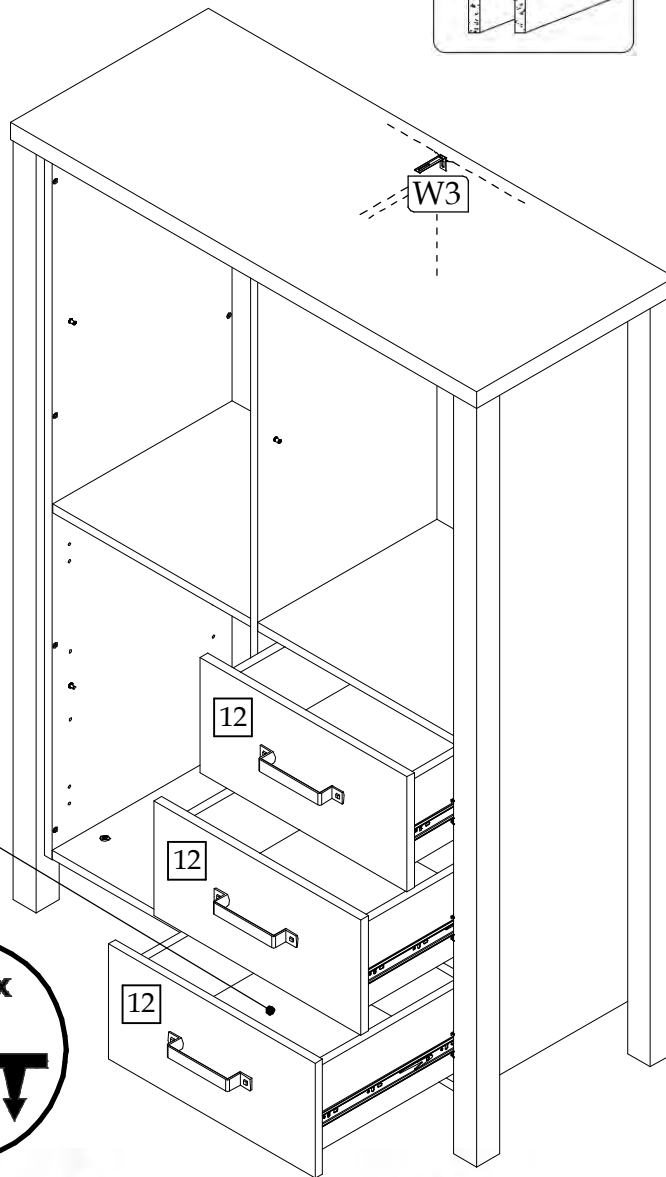
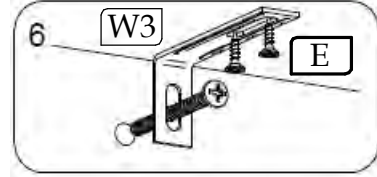
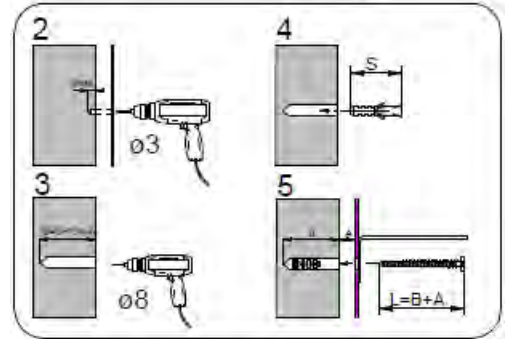
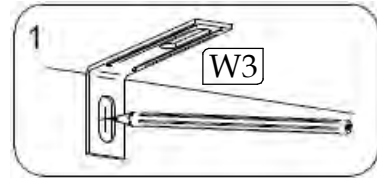
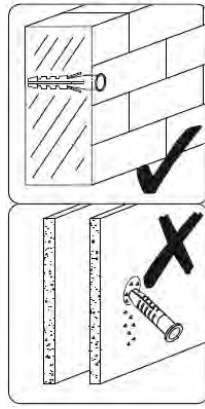
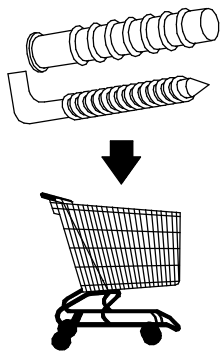

► 11

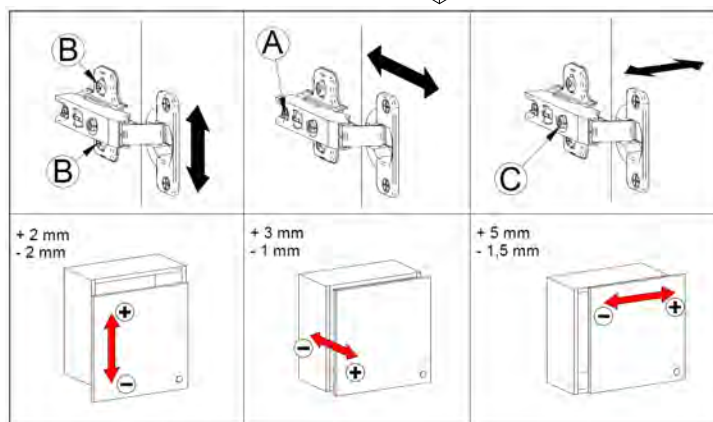
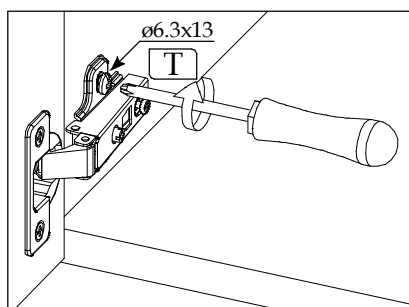
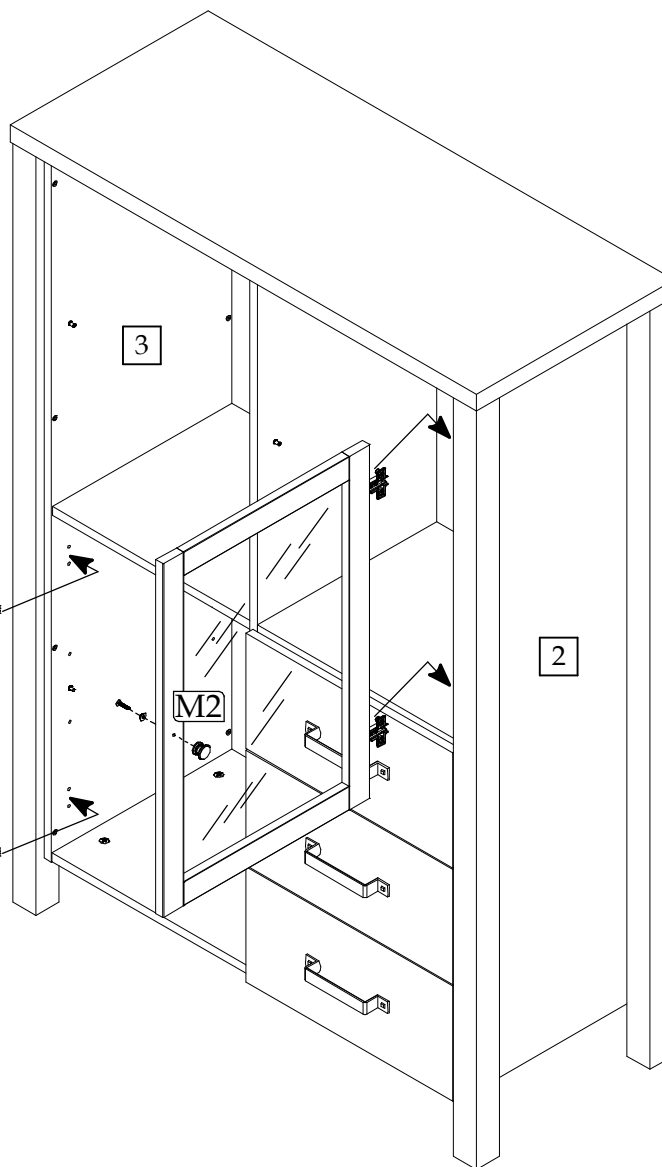
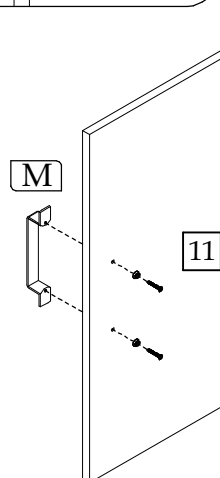
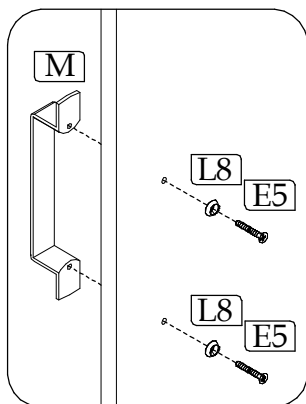
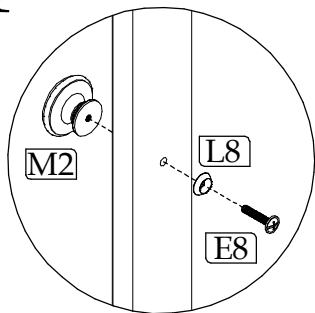

► 12

