

# Eridan

## Type A

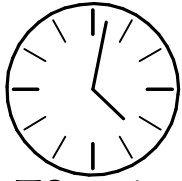

70 min

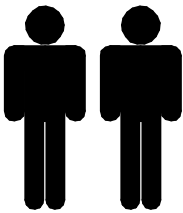

2005 mm

408 mm

477 mm

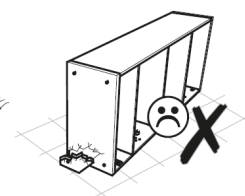
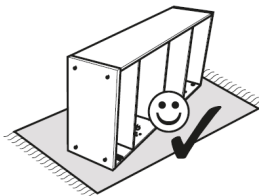
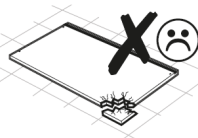
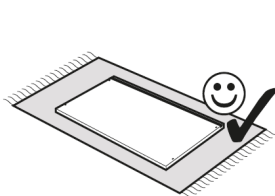
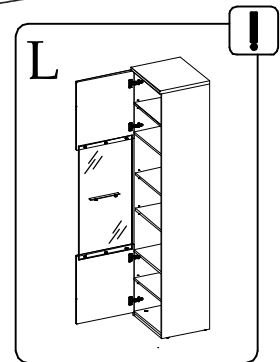
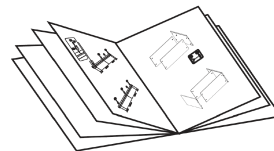
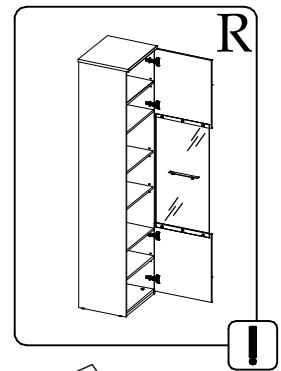
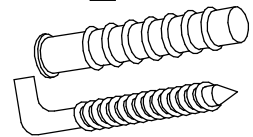
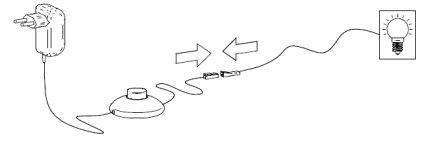

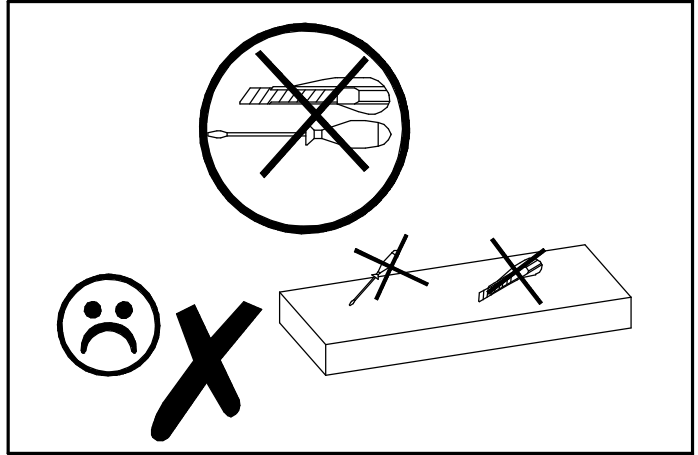
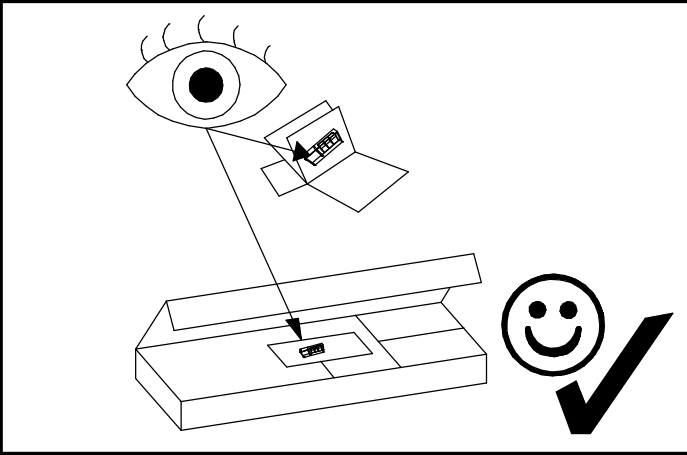

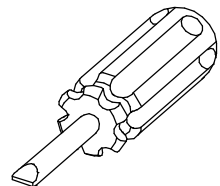
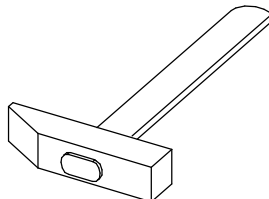
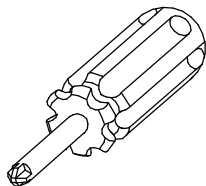
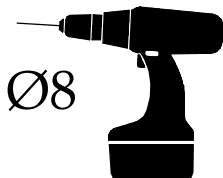
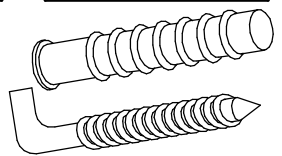
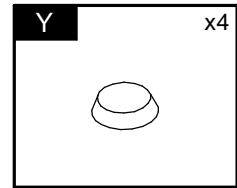
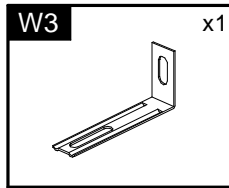
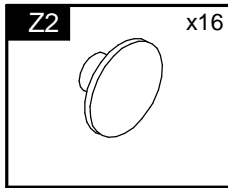
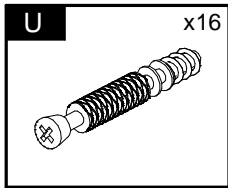
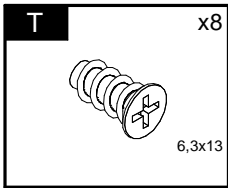
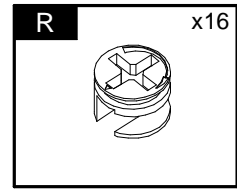
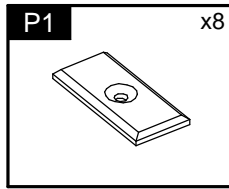
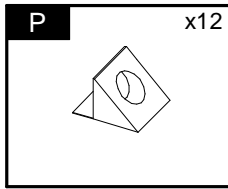
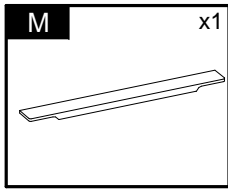
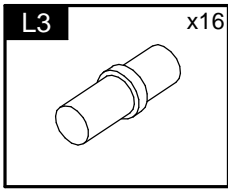
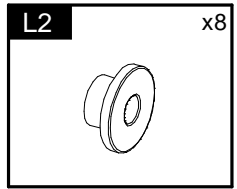
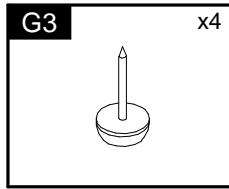
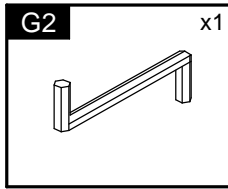
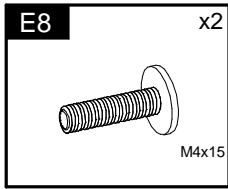
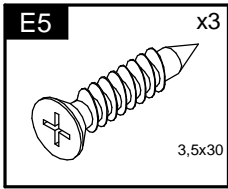
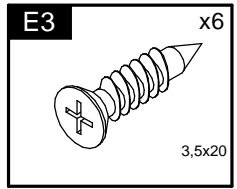
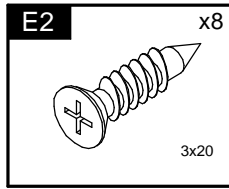
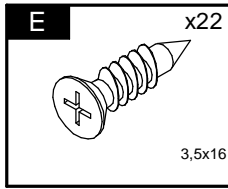
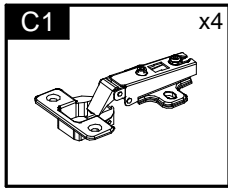
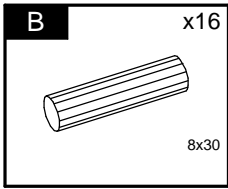
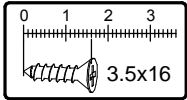

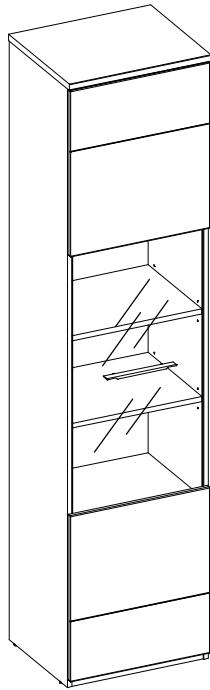

Element symbol	Measurements				Code	Pack
1	477	408	22	1	1002	2/3
2	443	70	22	1	1003	2/3
3	1978	391	16	1	1005	1/3
4	1978	391	16	1	1006	1/3
5	443	390	16	1	1007/2007	1/3
6	443	370	16	1	1032	1/3
7	443	370	16	1	1040	1/3
8	443	356	16	1	N/A	1/3
9	443	356	16	1	N/A	1/3
10	443	356	16	1	N/A	1/3
11	443	356	16	1	N/A	1/3
12	509.5	457	3	1	N/A	2/3
13	228.5	951	3	2	N/A	1/3
14	493.5	457	3	1	N/A	2/3
15	550	472	16	1	1008/3001	2/3
16	550	472	16	1	1008/3002	2/3
17	915	438	4	1	N/A	3/3

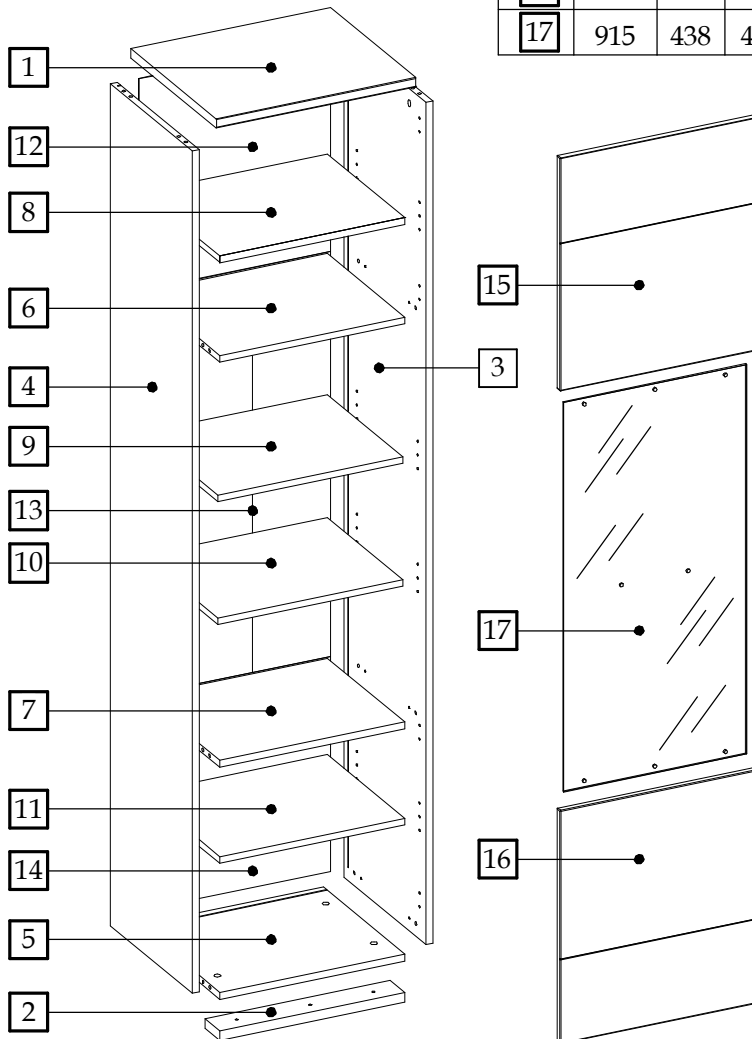

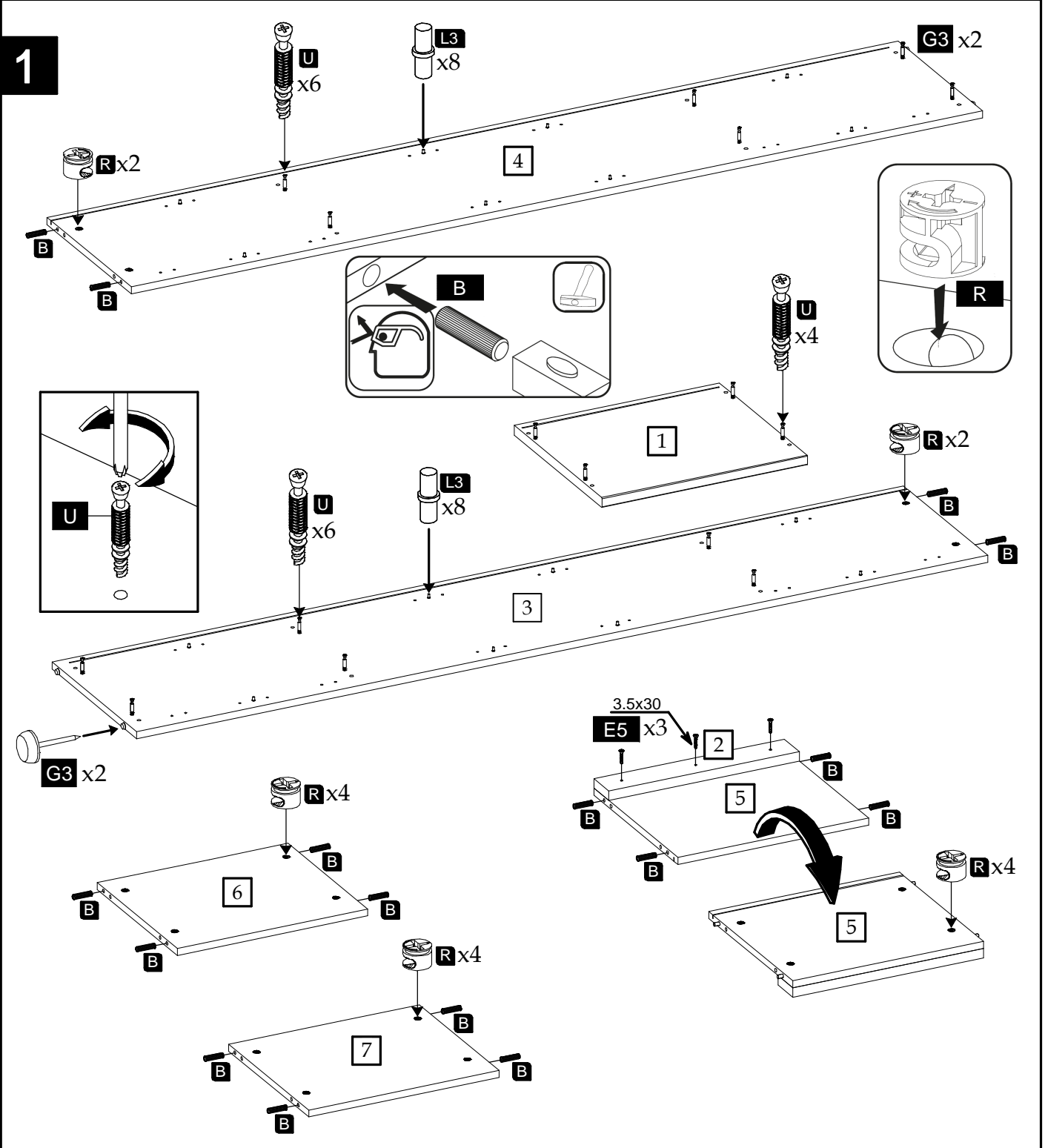

2

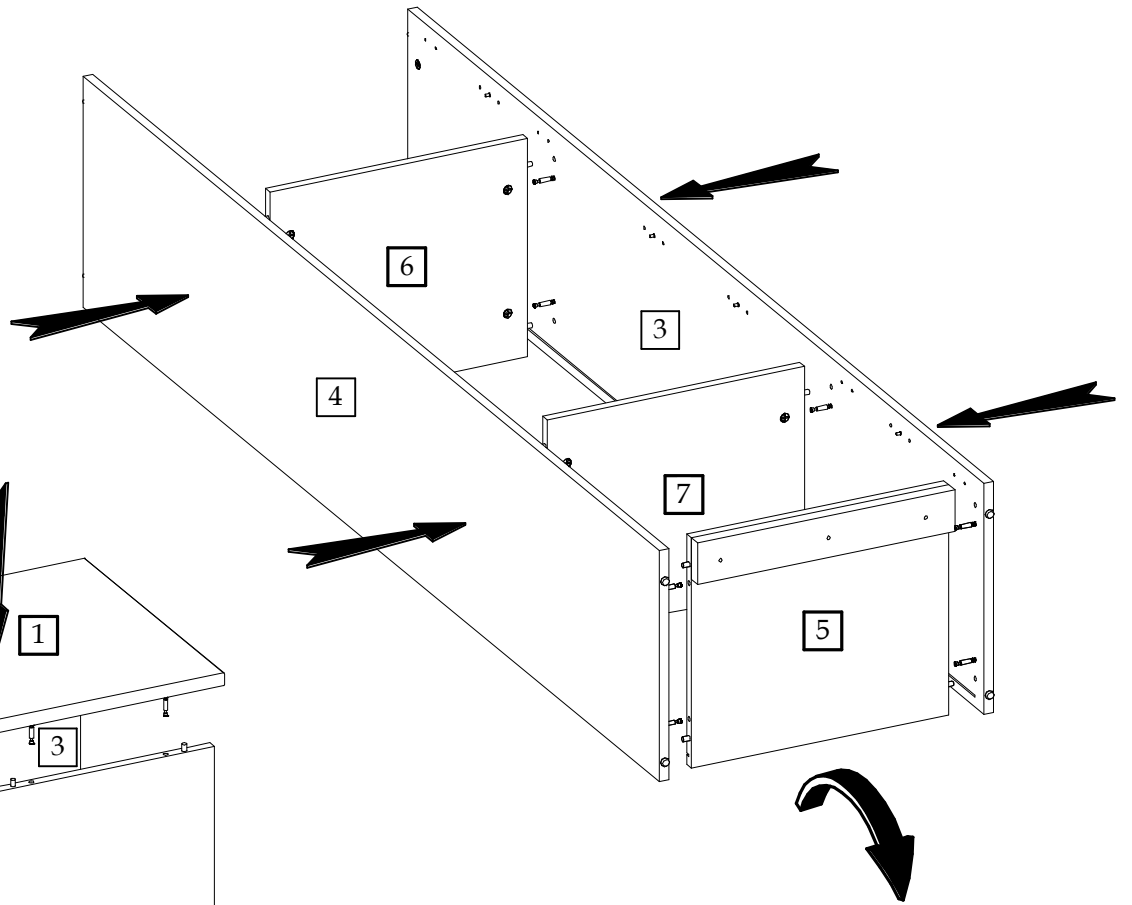

3

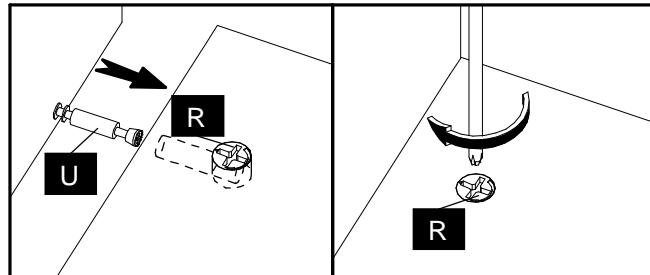
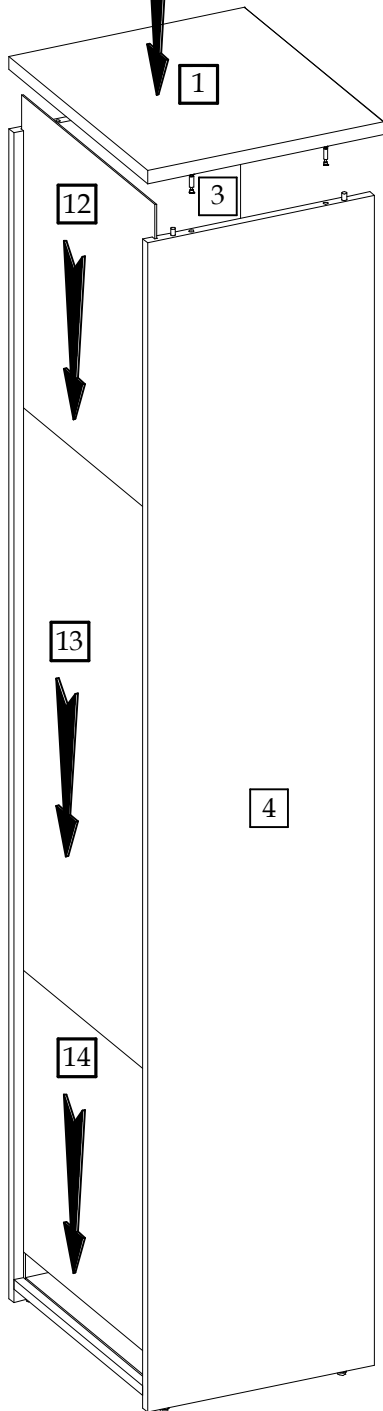

4

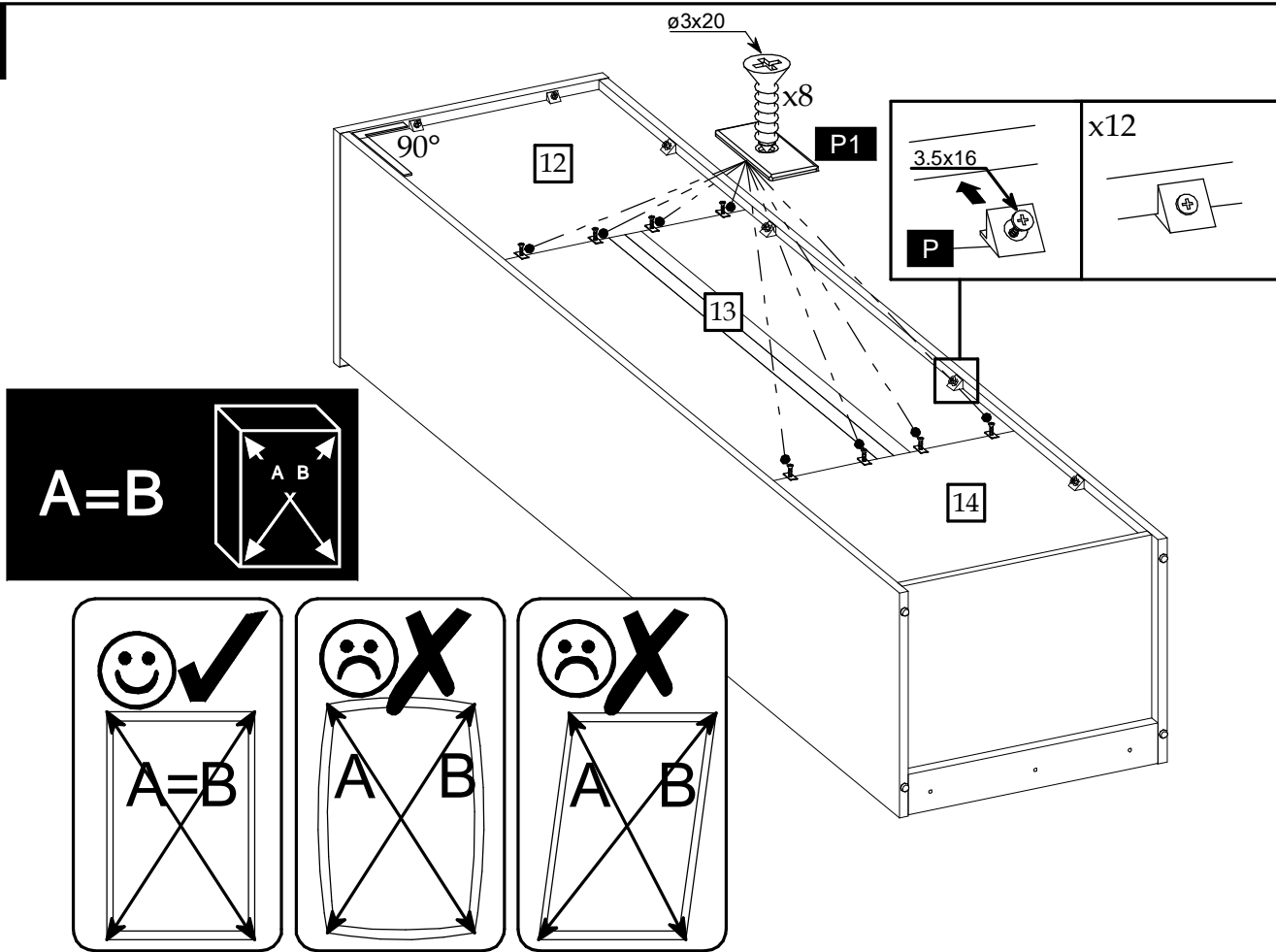

5

