

Eridan

Type I

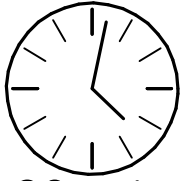

90 min

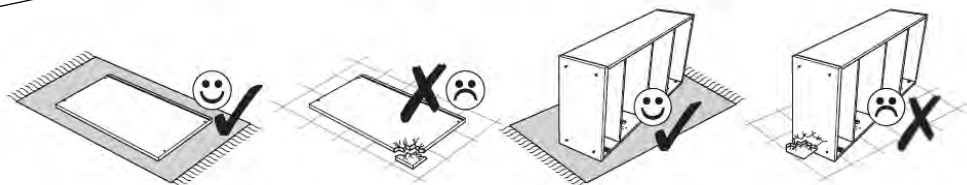
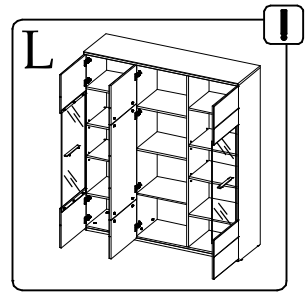
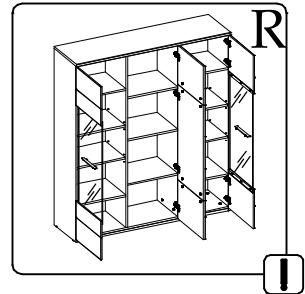
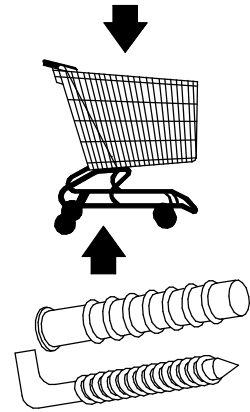
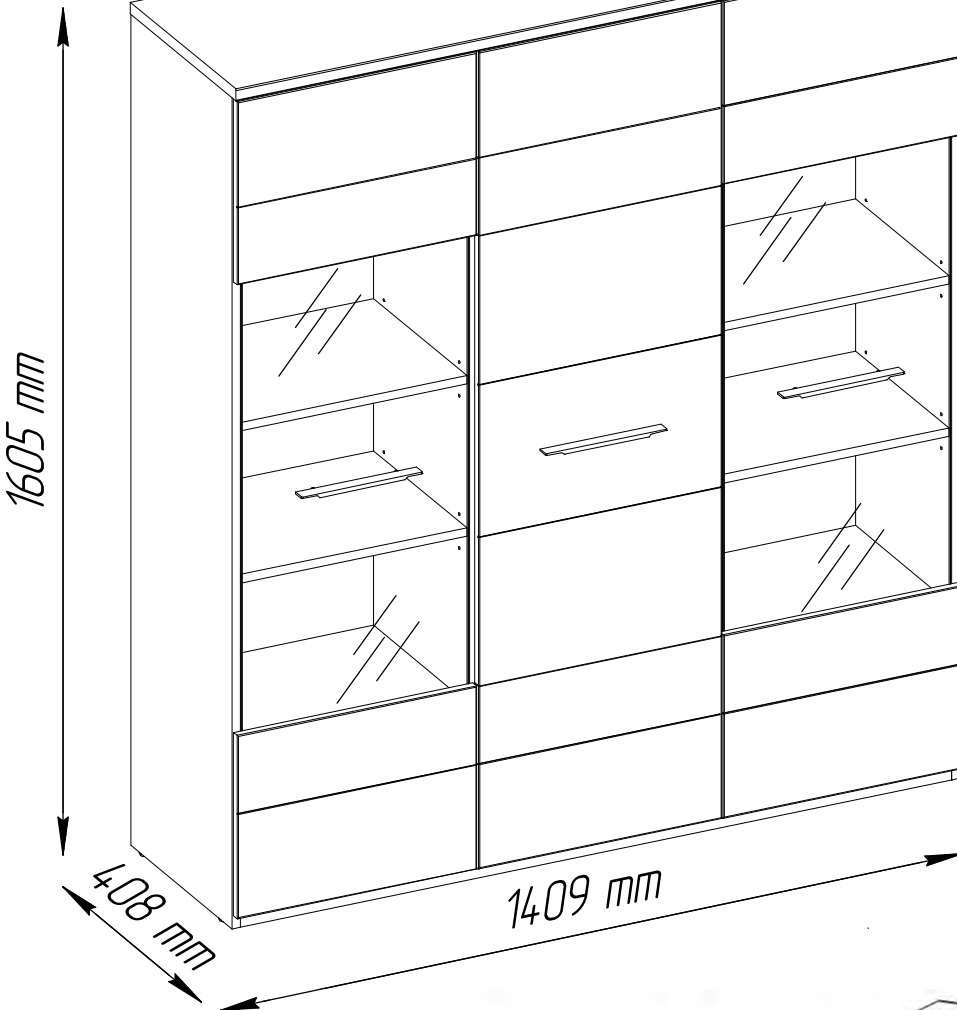
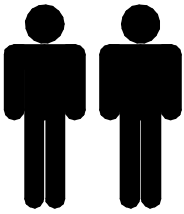

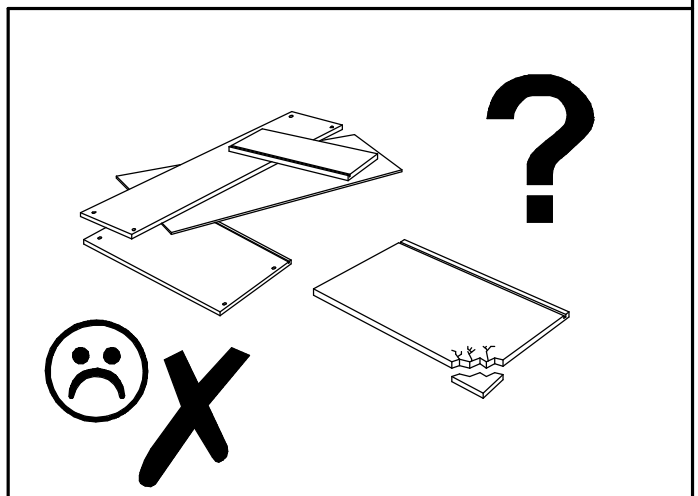
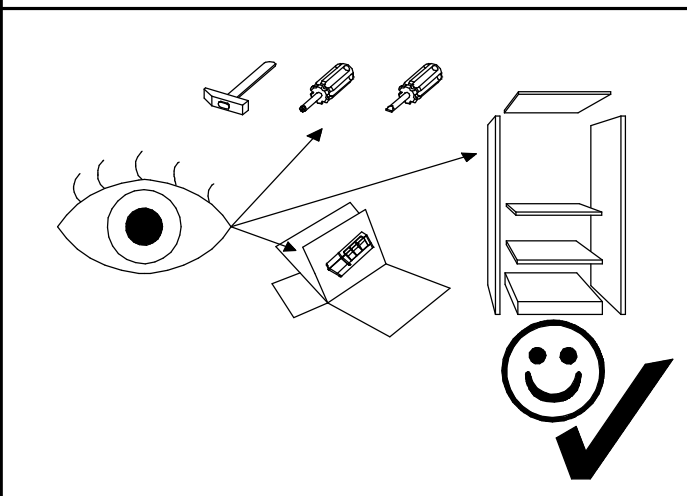
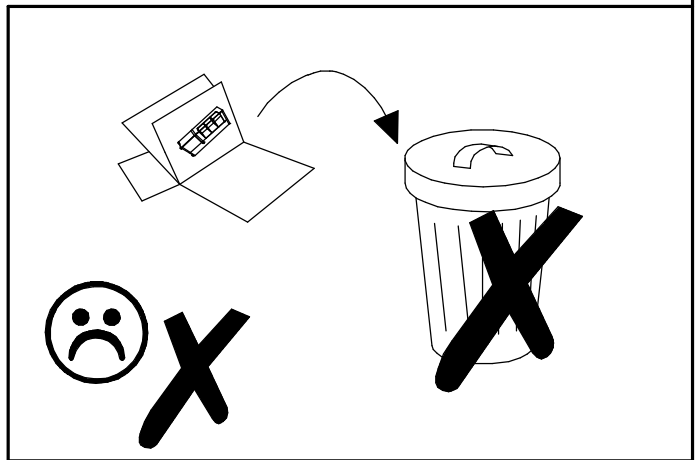
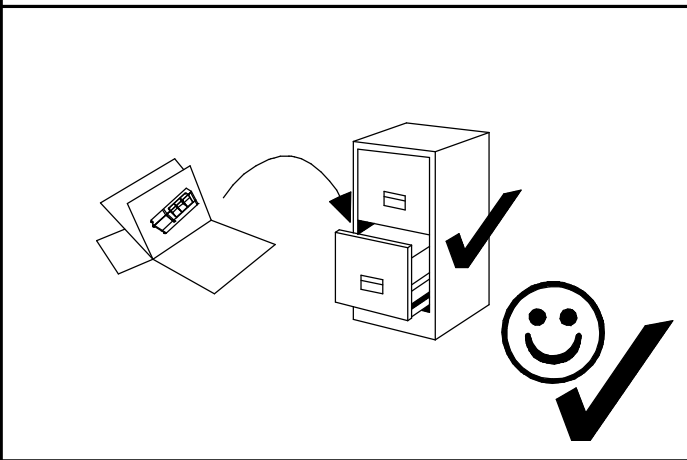
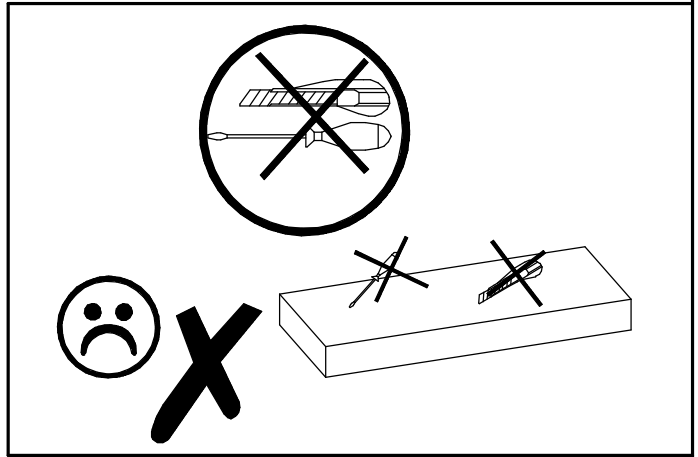
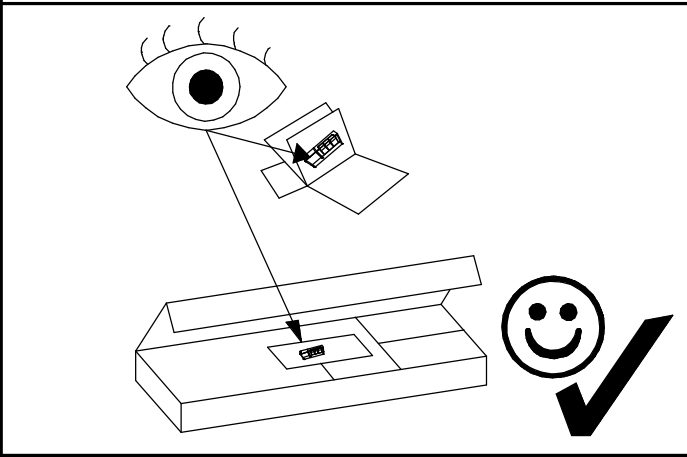

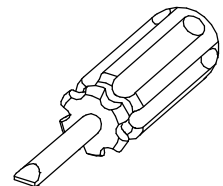
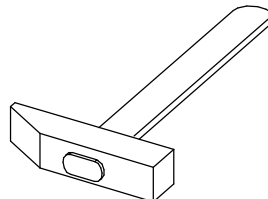
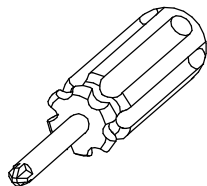
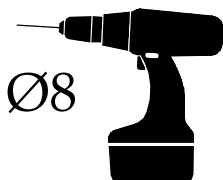
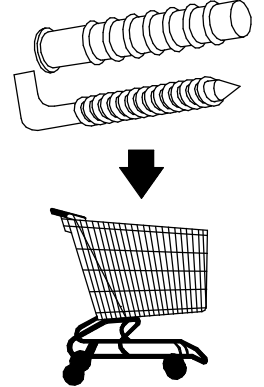
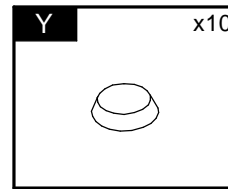
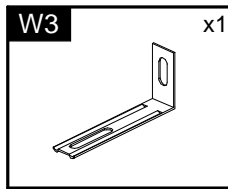
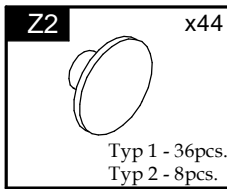
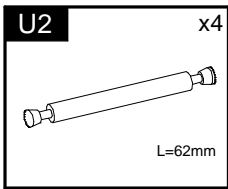
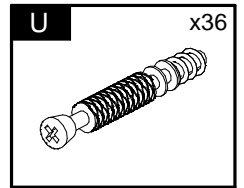
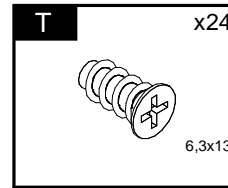
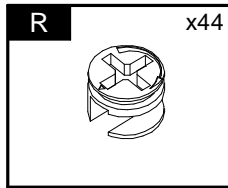
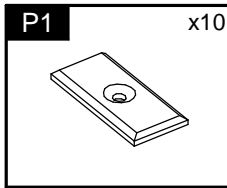
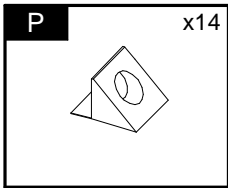
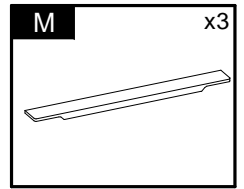
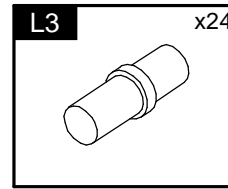
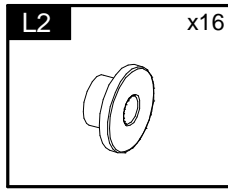
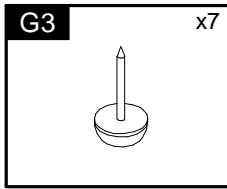
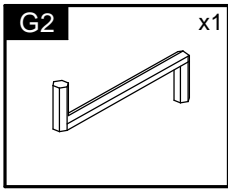
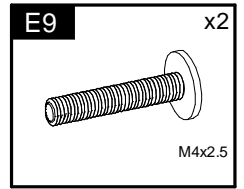
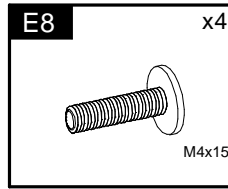
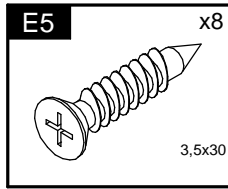
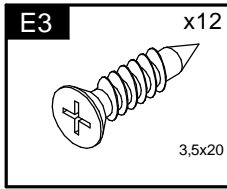
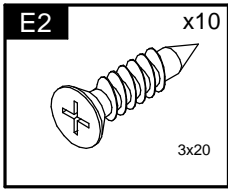
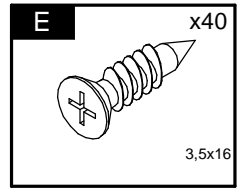
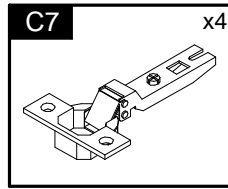
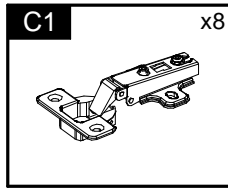
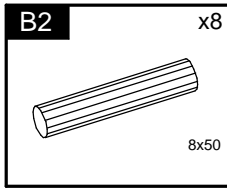
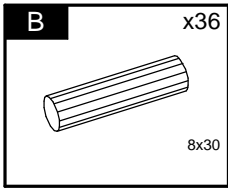
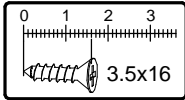
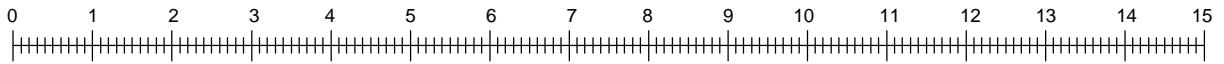

Element symbol	Measurements					Code	Pack
1	1409	408	22	1		1002	1/4
2	1375	70	22	1		1003	1/4
3	319	70	22	1		1004	1/4
4	1578	391	16	1		1005	2/4
5	1578	391	16	1		1006	2/4
6	1375	390	16	1		1007/2007	2/4
7	1540	369.5	16	1		1070/2070	1/4
8	1540	369.5	16	1		1061/2061	2/4
9	443	370	16	1		1045	1/4
10	443	370	16	1		1010	1/4
11	443	370	16	1		1064	1/4
12	443	370	16	1		1065	1/4
13	457	369	16	1		1012	1/4
14	443	356	16	1		N/A	1/4

Element symbol	Measurements					Code	Pack
15	443	356	16	1		N/A	1/4
16	443	356	16	1		N/A	1/4
17	443	356	16	1		N/A	1/4
18	457	368	16	1		N/A	1/4
19	457	368	16	1		N/A	1/4
20	1554	458	3	2		N/A	2/4
21	1554	473	3	1		1050_v	2/4
22	350	465	16	2		1016/3001	3/4
23	350	465	16	2		1016/3002	3/4
24	350	472	16	1		1017/3003	3/4
25	857	472	16	1		1010/3004	3/4
26	350	472	16	1		1017/3005	3/4
27	915	438	4	2		N/A	4/4

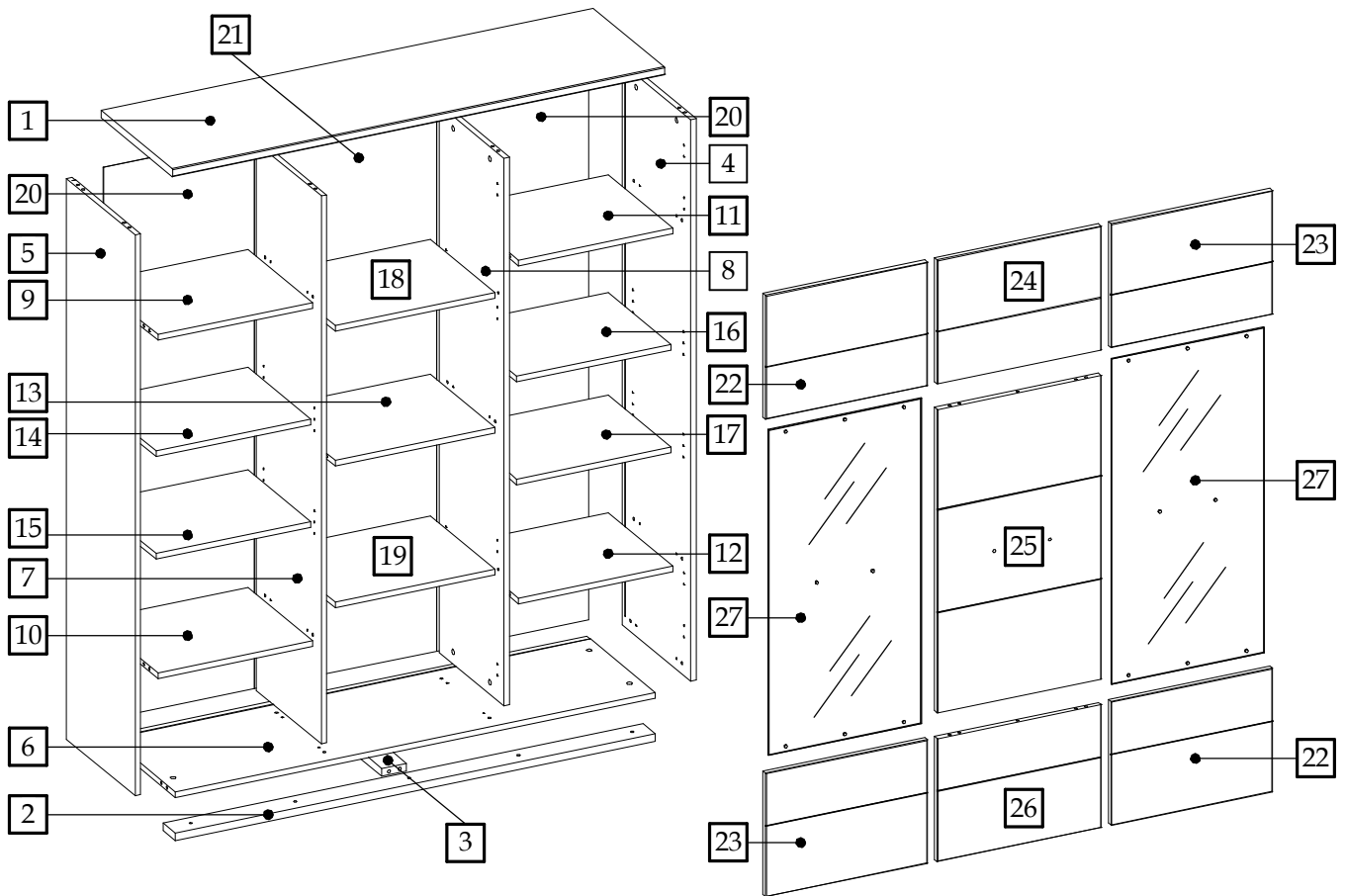

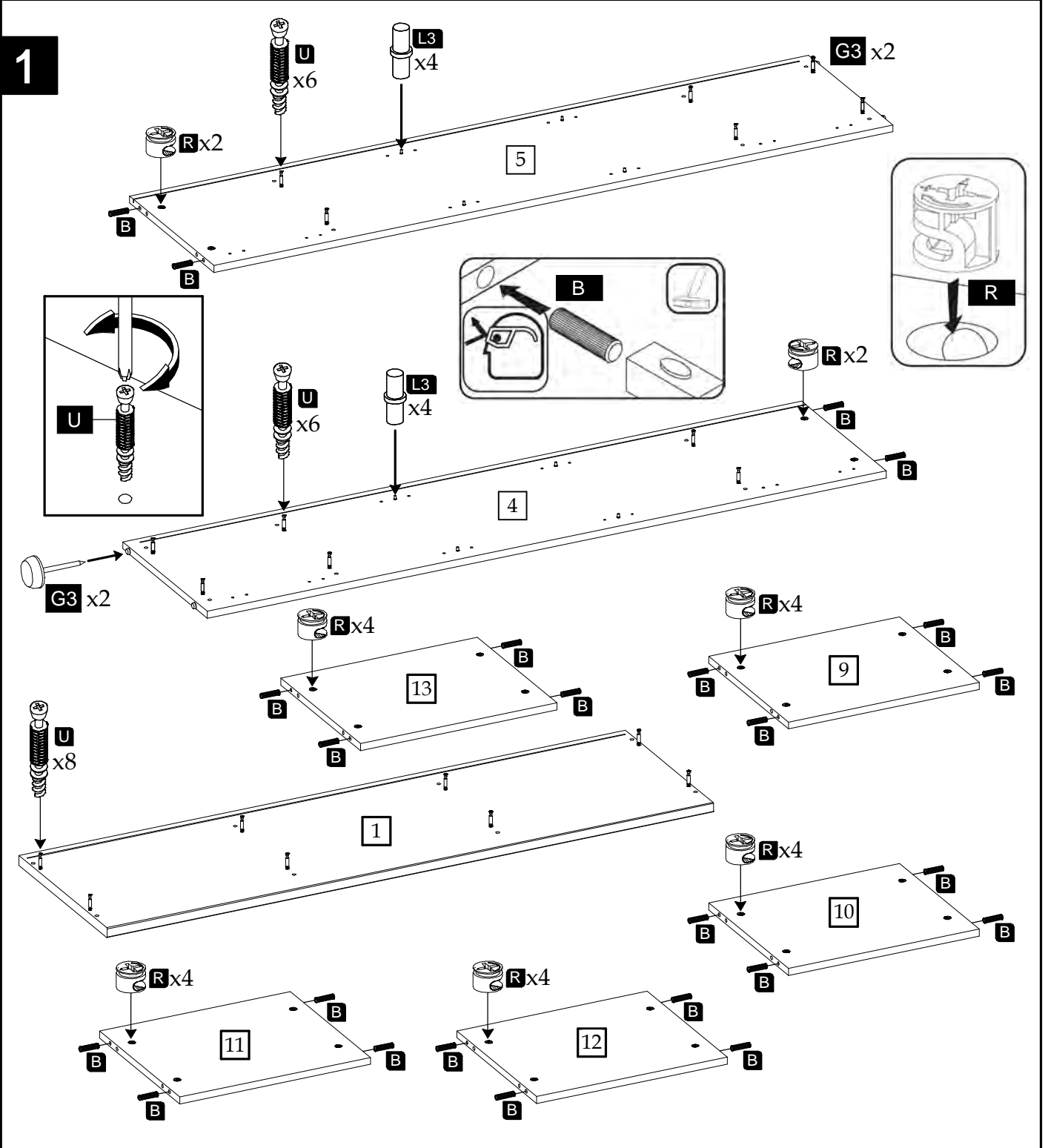
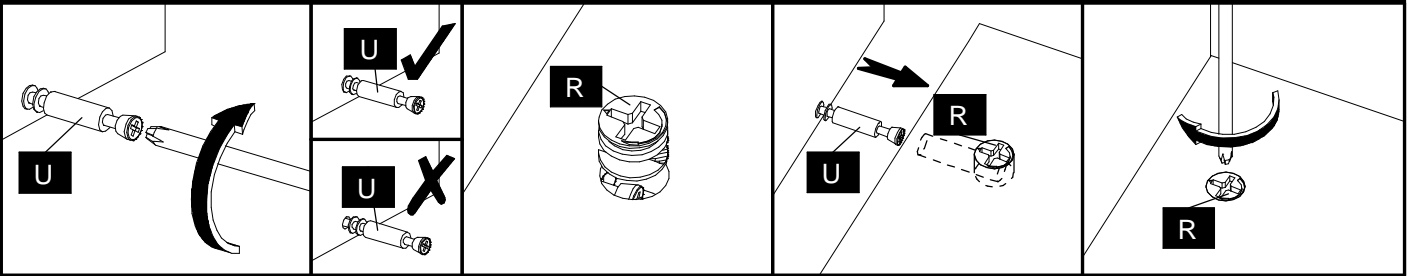

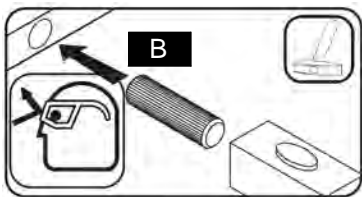
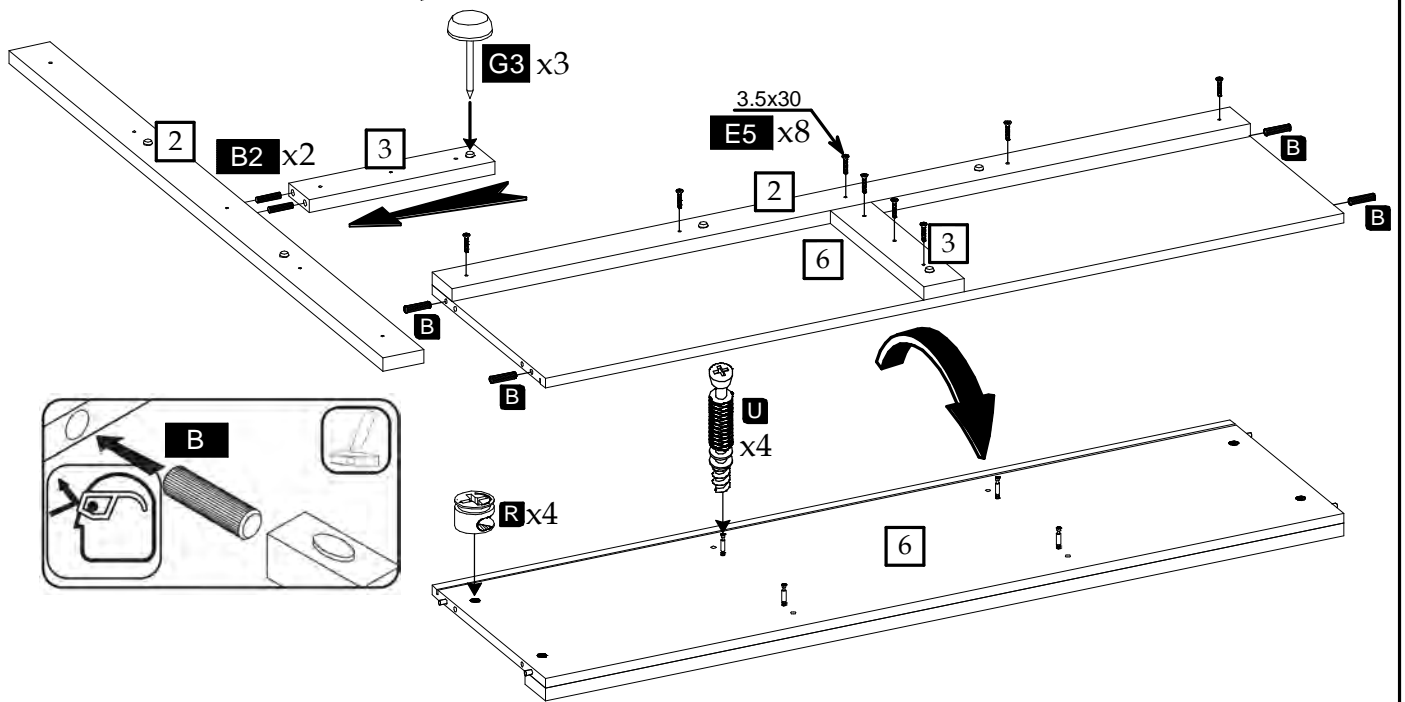
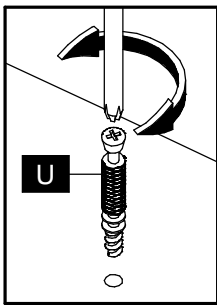
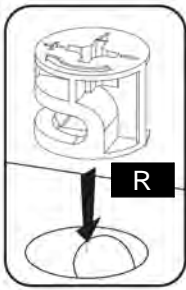
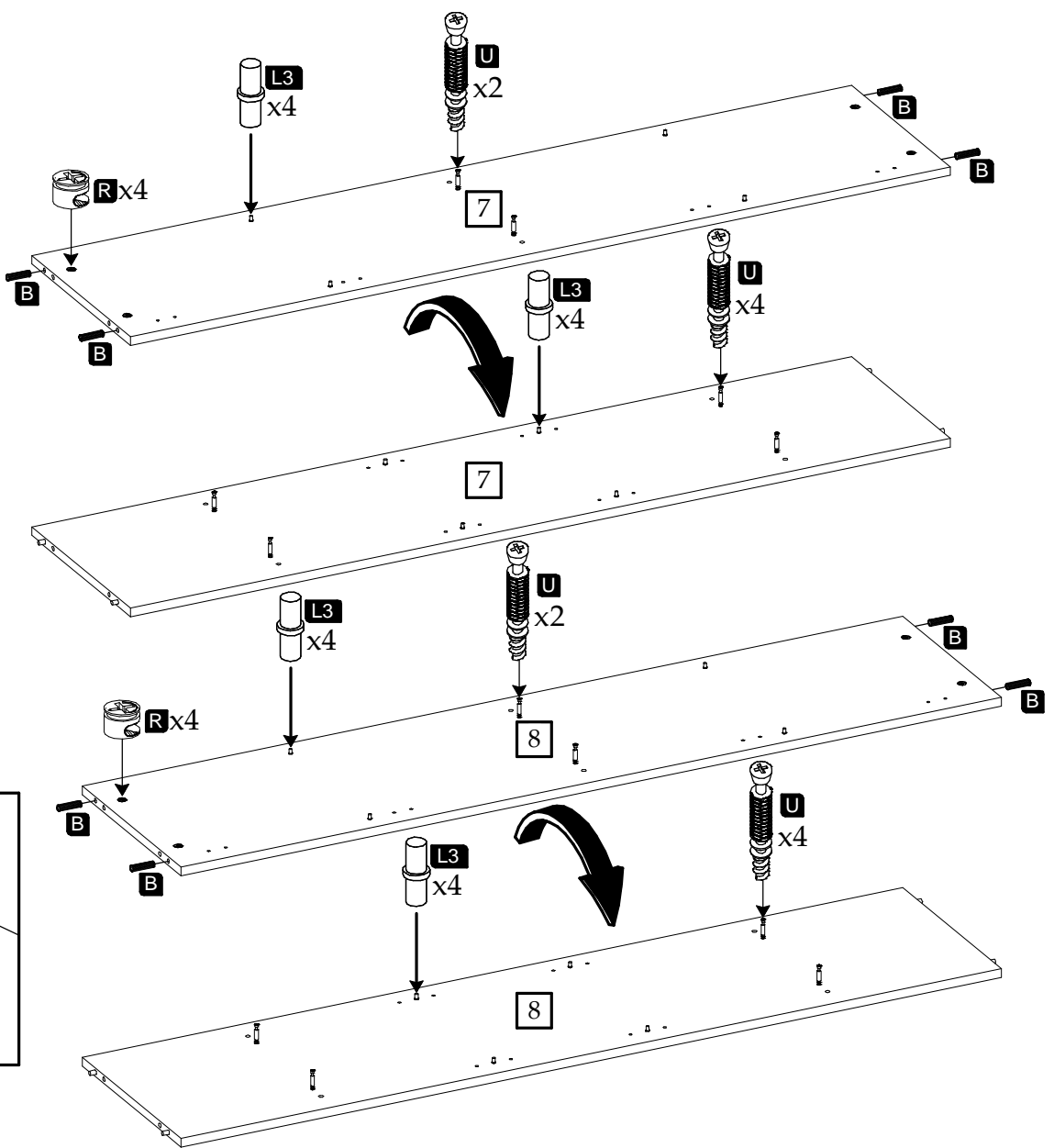

3

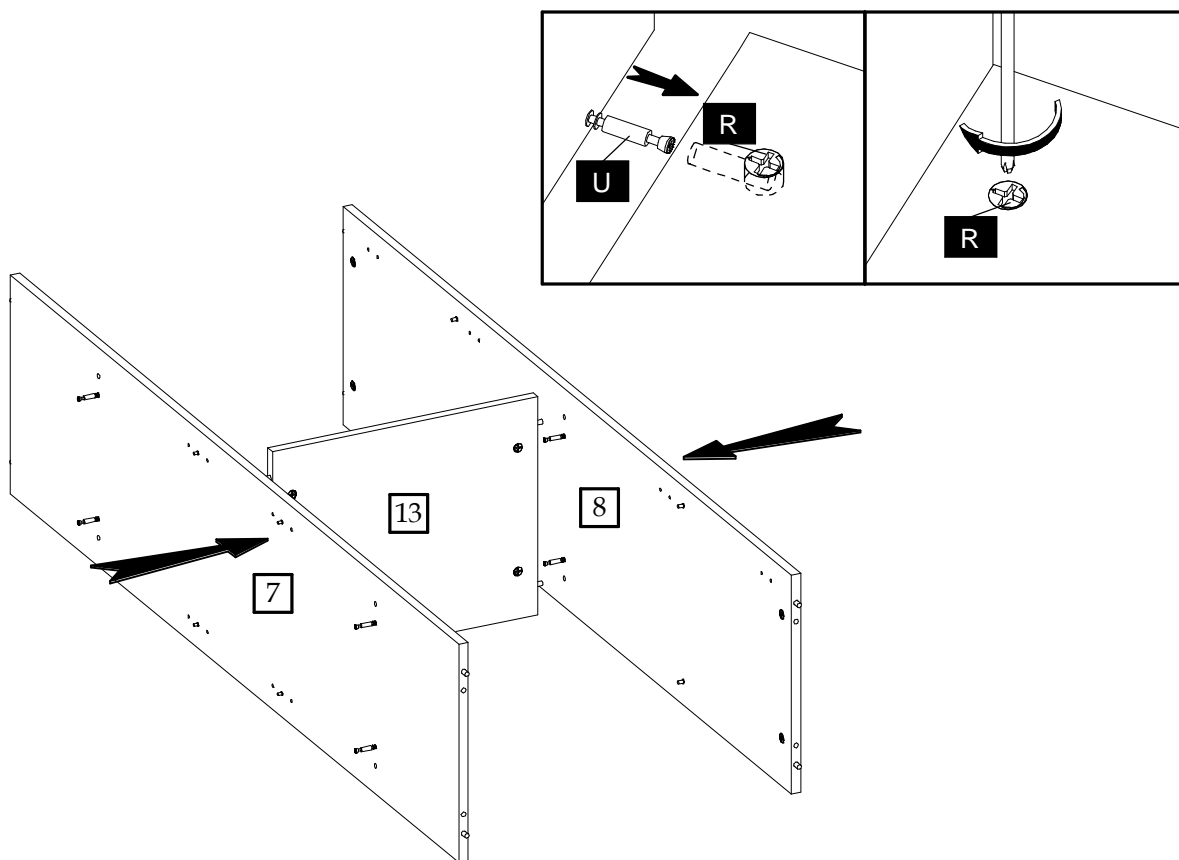

4

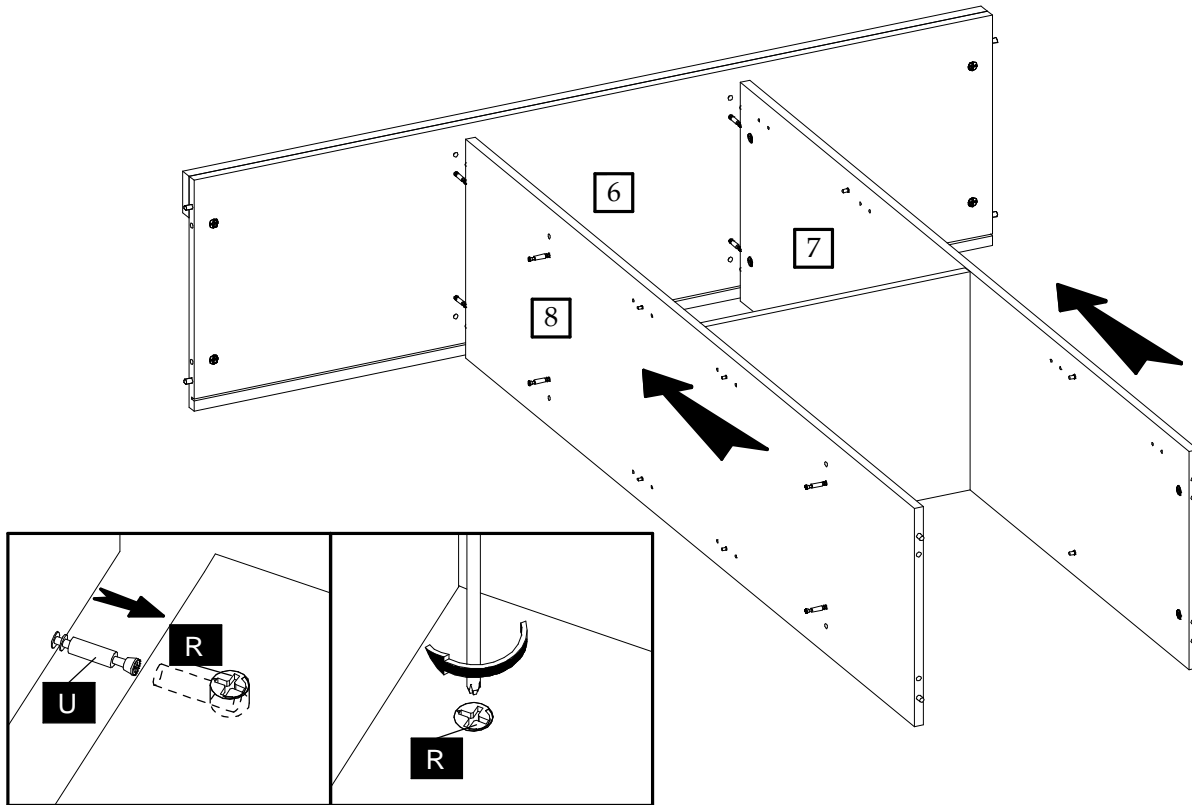

5

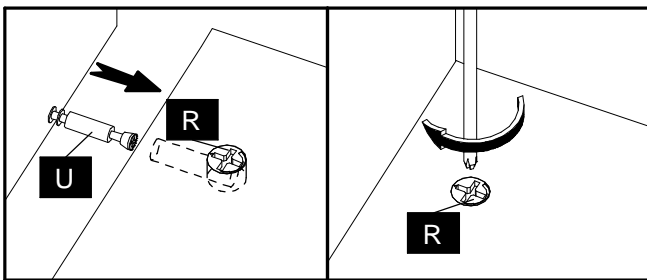
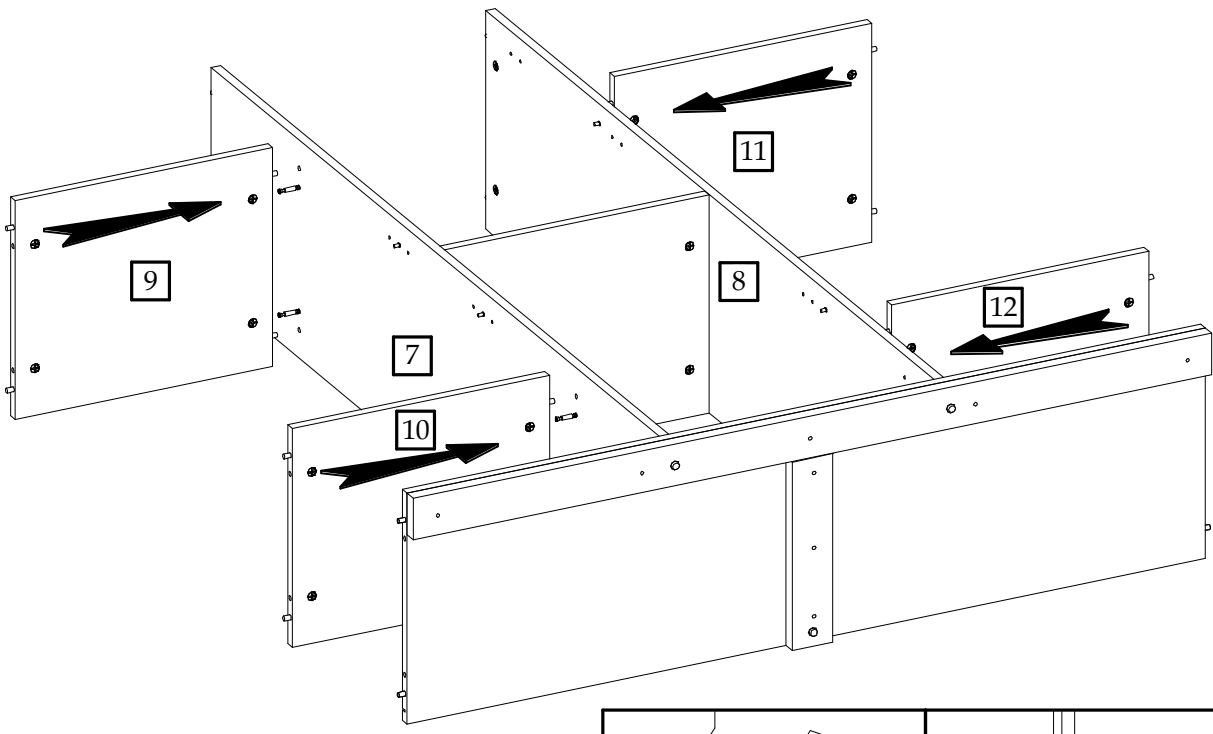

6

