

# Eridan

## Type R2

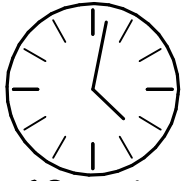

60 min

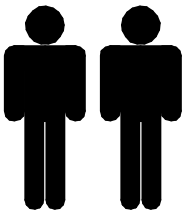

2005 mm

408 mm

477 mm

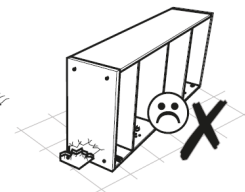
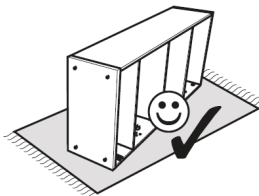
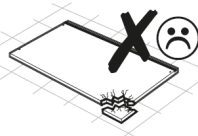
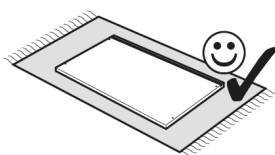
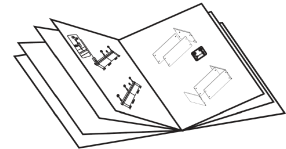
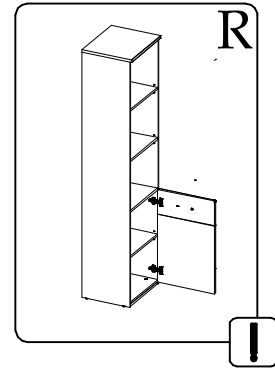
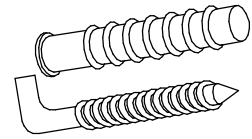

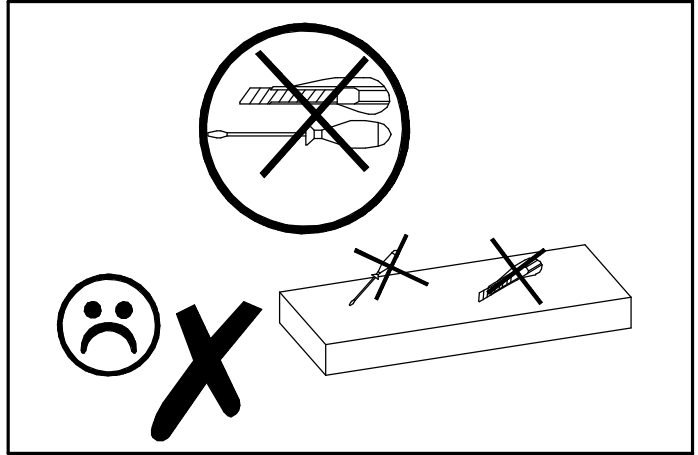
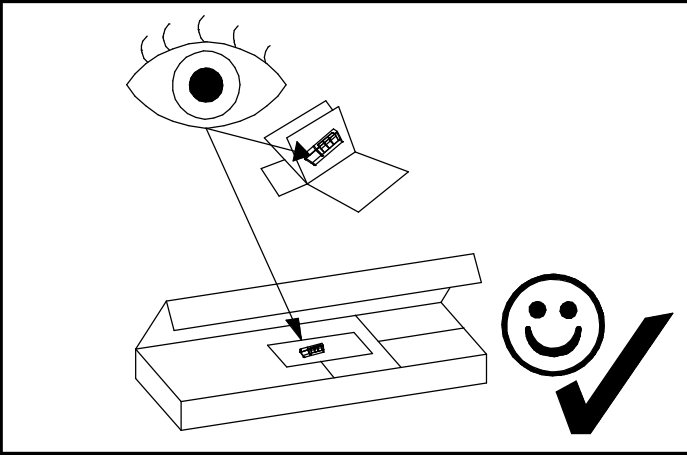

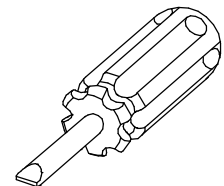
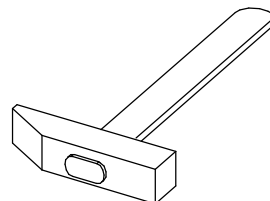
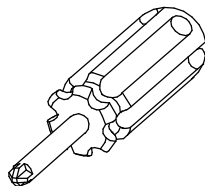
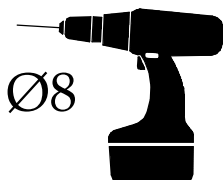
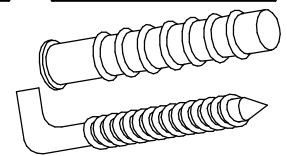
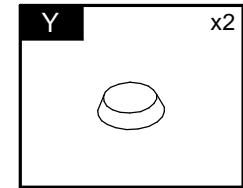
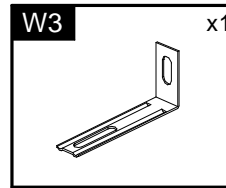
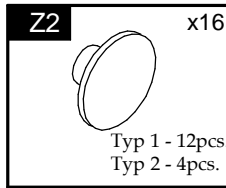
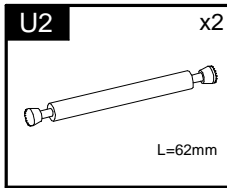
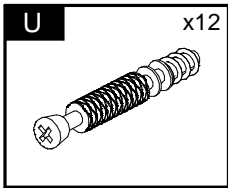
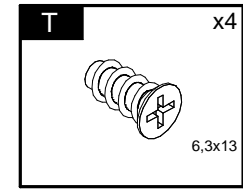
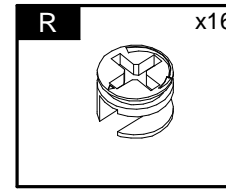
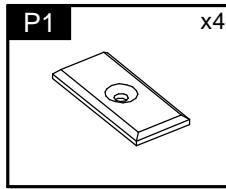
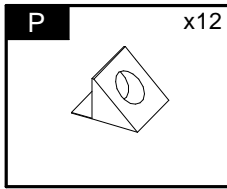
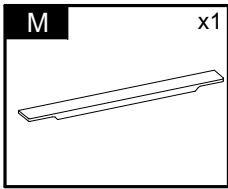
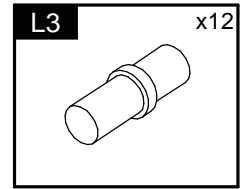
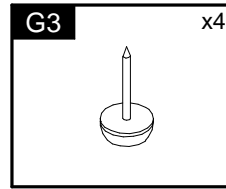
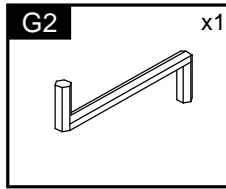
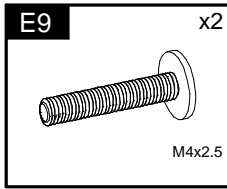
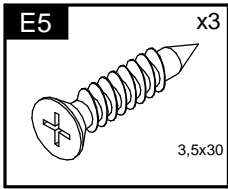
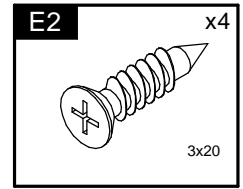
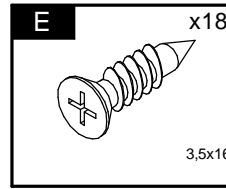
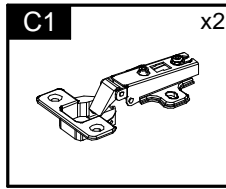
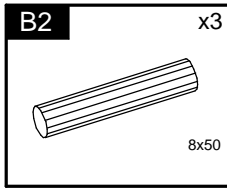
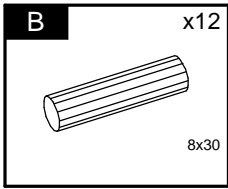
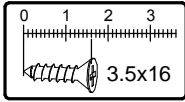
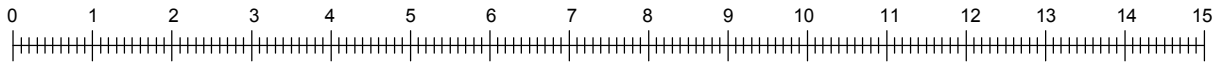

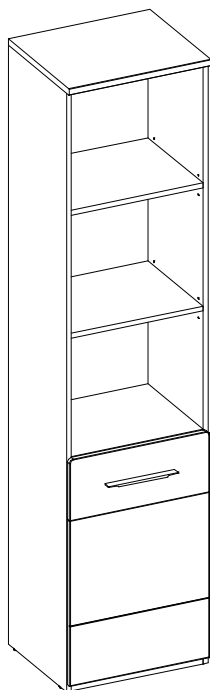

Element symbol	Measurements				Code	Pack
1	477	408	22	1	1002	1/2
2	443	70	22	1	1003	1/2
3	1978	391	16	1	1005	1/2
4	1978	391	16	1	1006	1/2
5	443	390	16	1	1007/2007	1/2
6	443	370	16	1	1040	1/2
7	443	368	16	1	N/A	1/2
8	443	368	16	1	N/A	1/2
9	443	368	16	1	N/A	1/2
10	457	1218	3	1	N/A	1/2
11	736	457	3	1	N/A	1/2
12	472	202	16	1	1013/3001	2/2
13	550	472	16	1	1008/3002	2/2

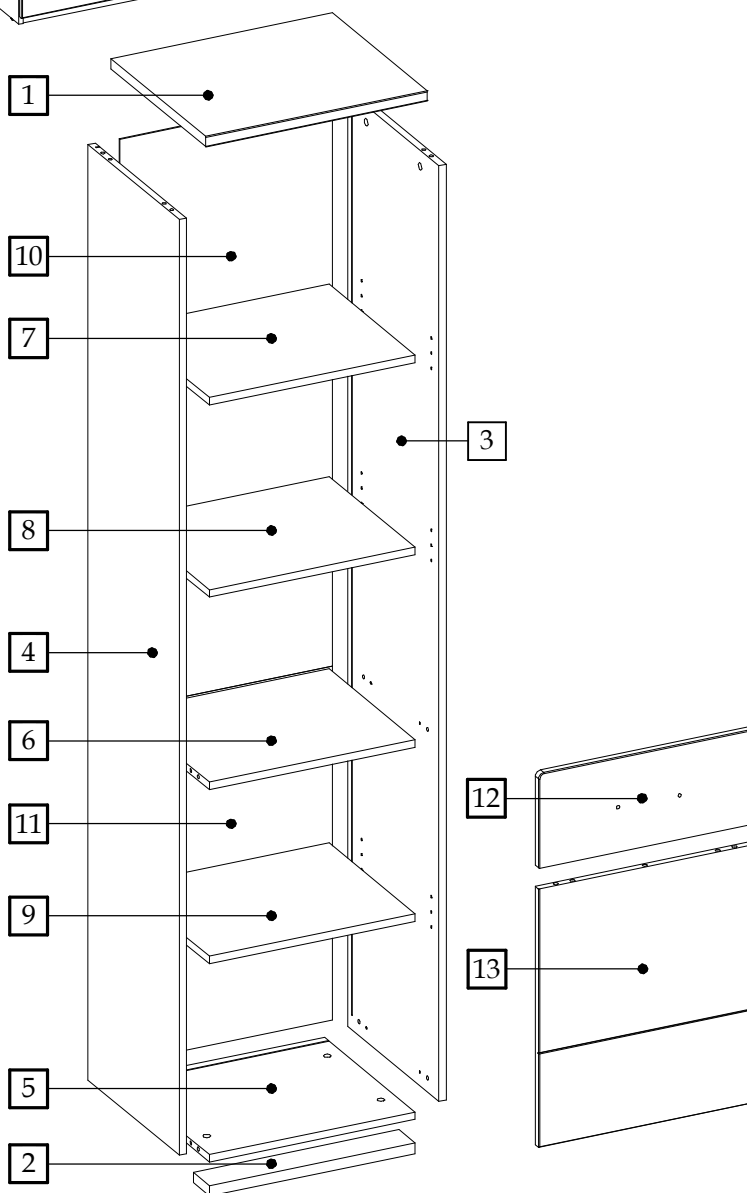

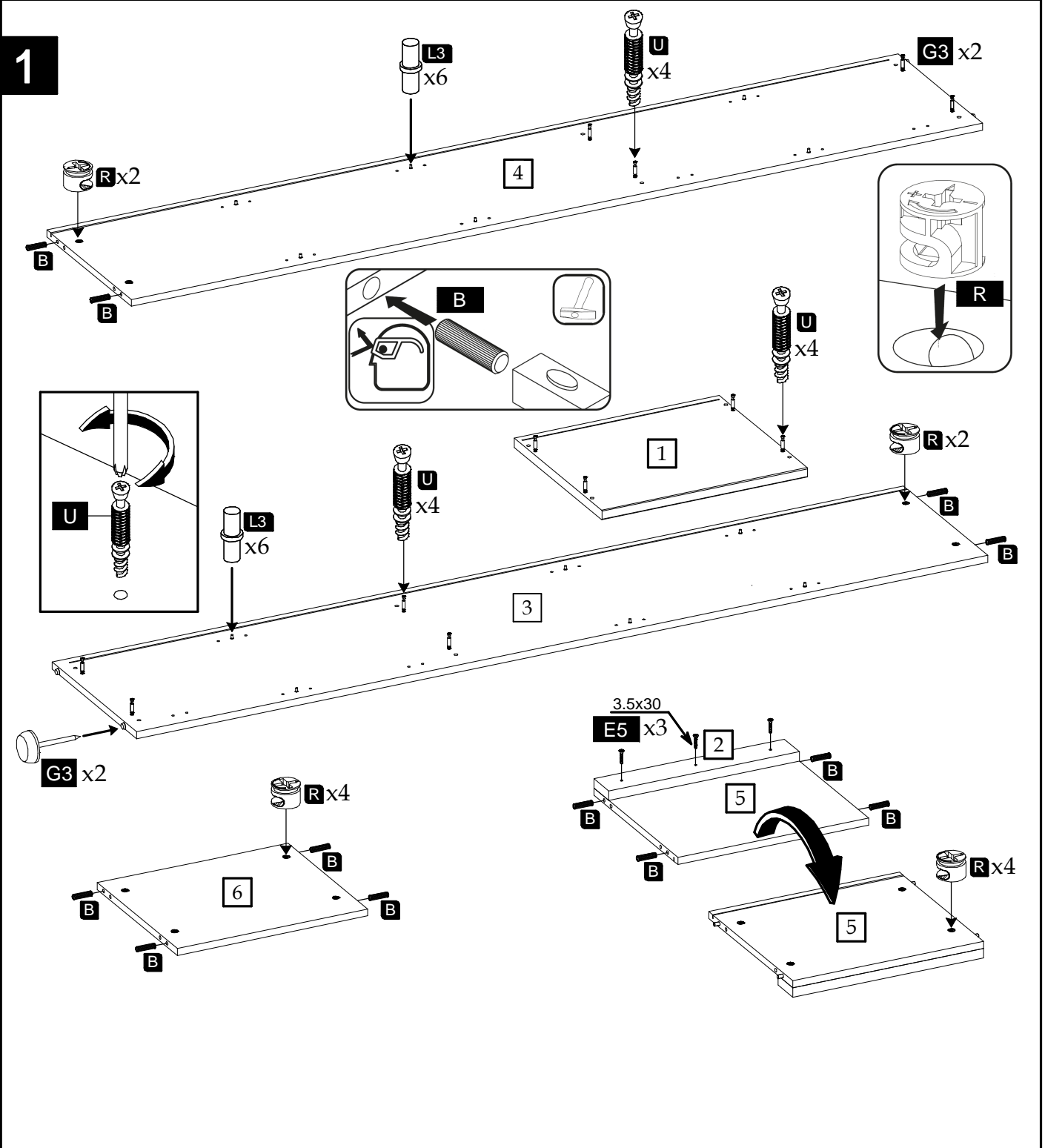
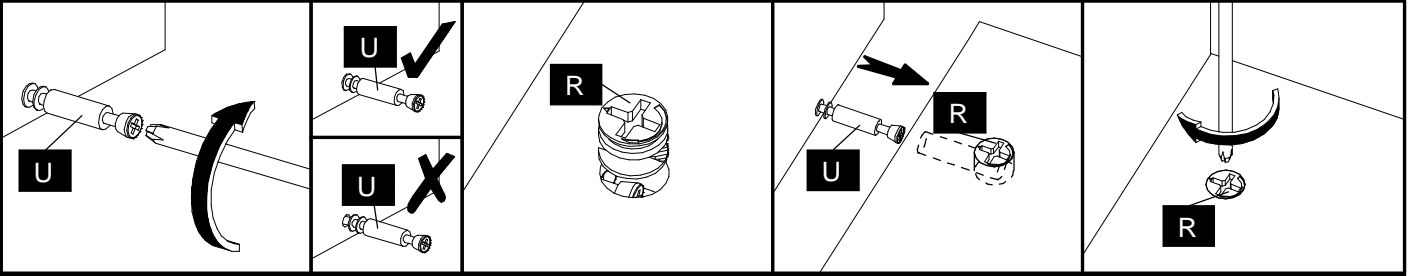

2

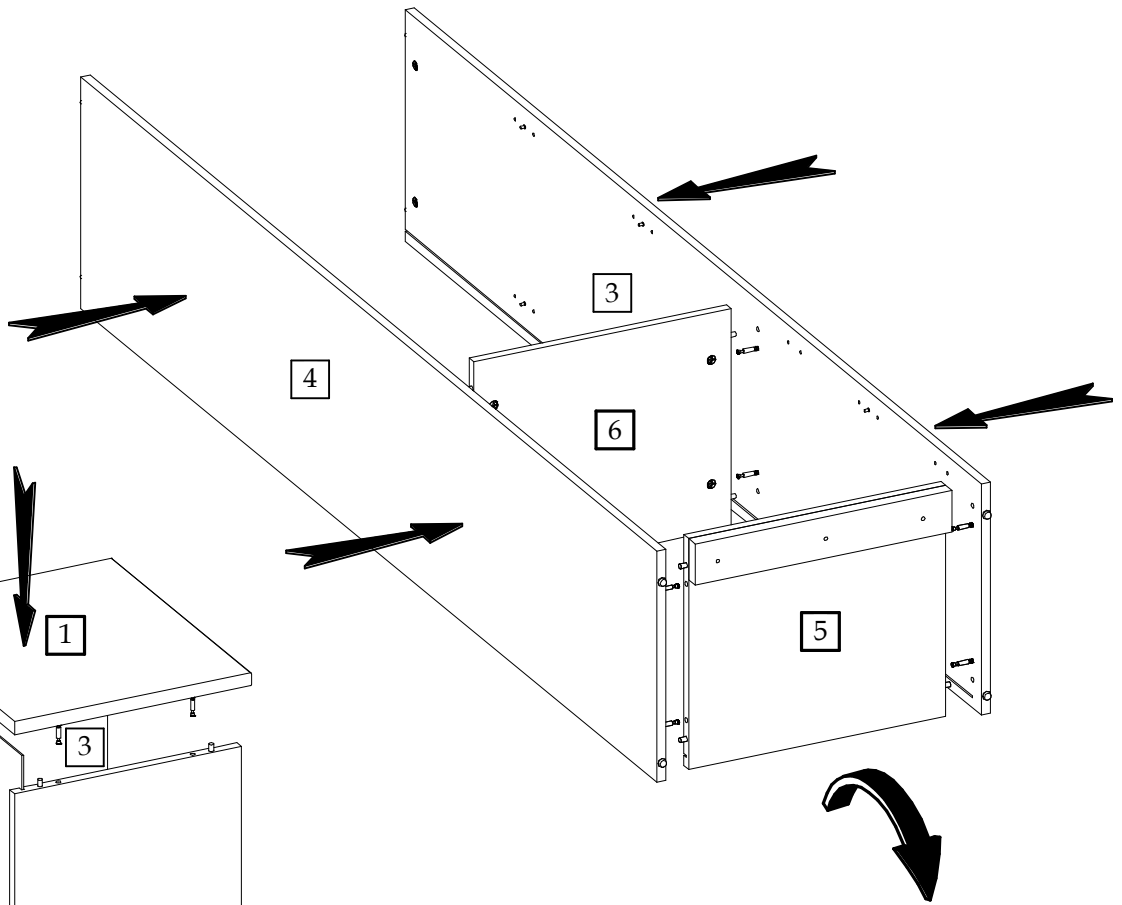

3

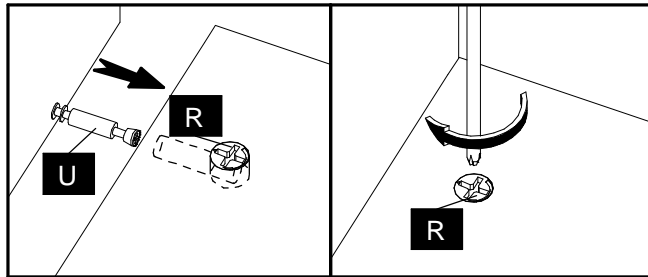
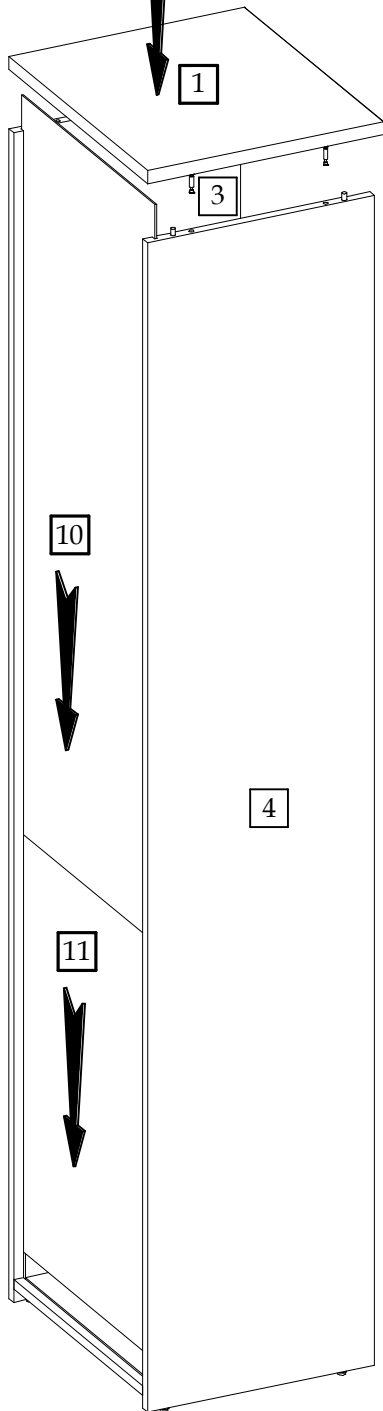

4

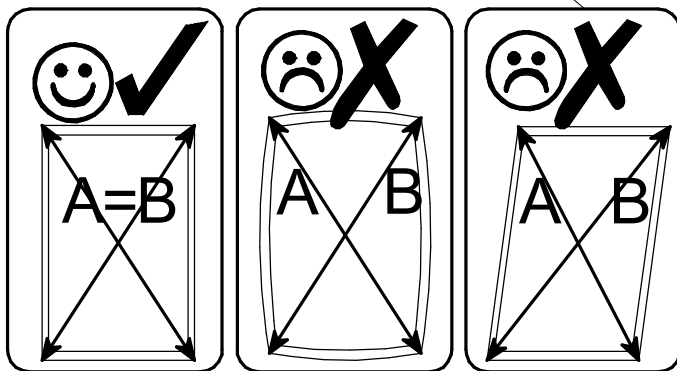
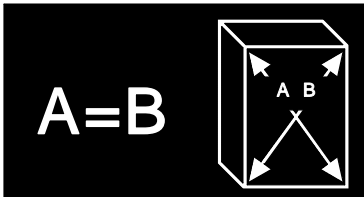
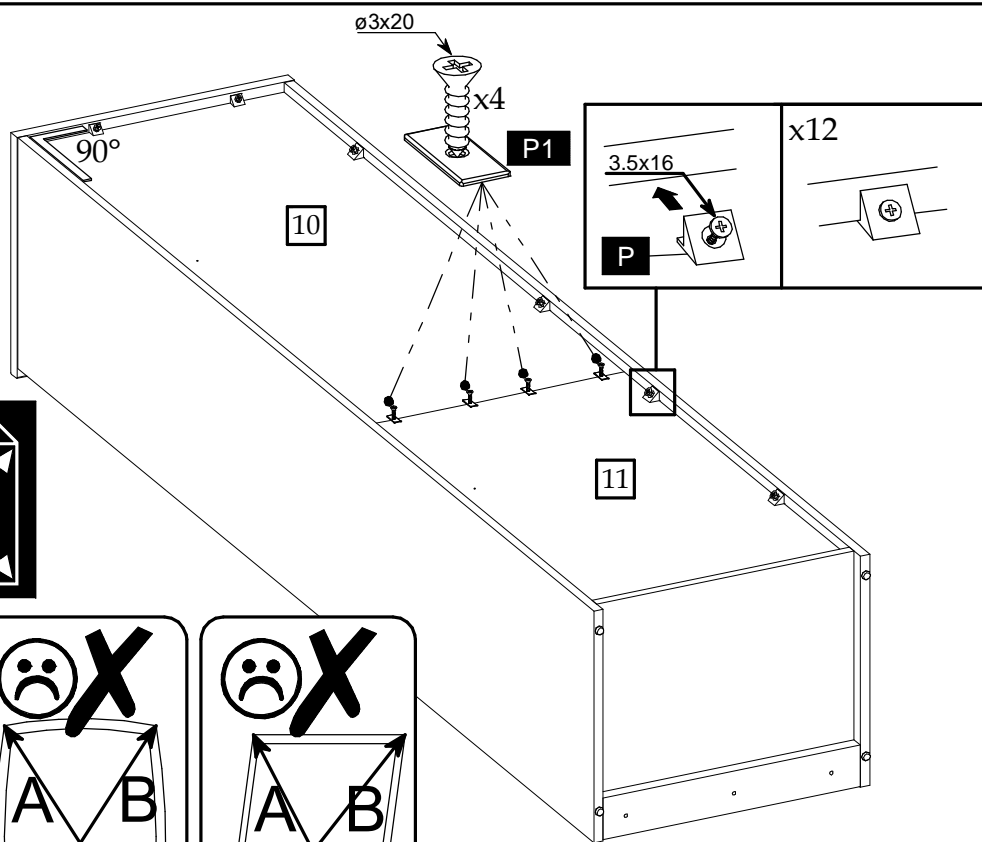

5

