

FIDEL

Typ A2

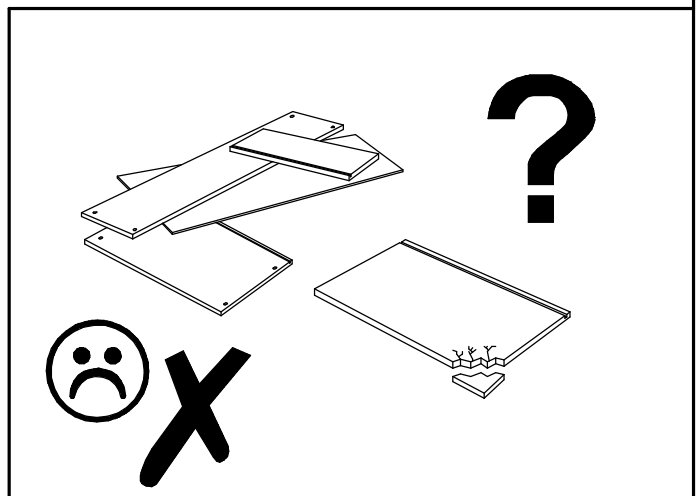

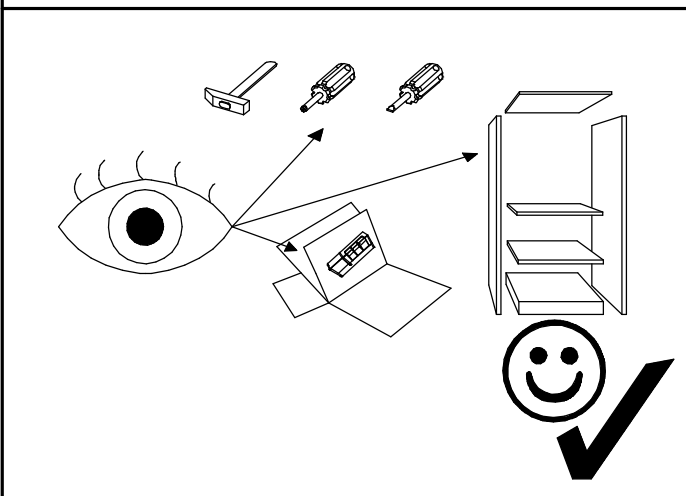

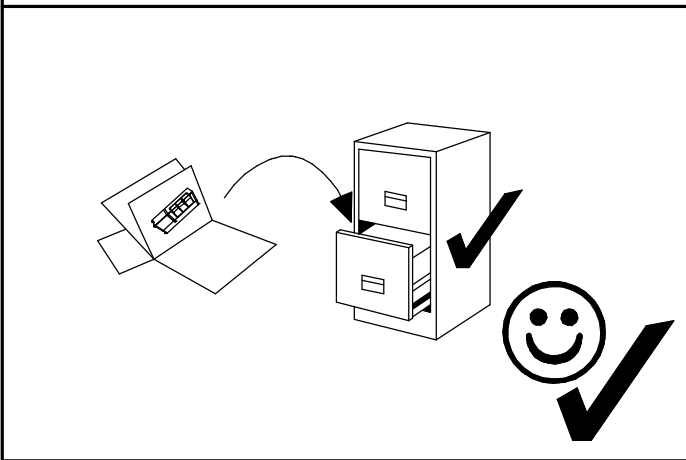
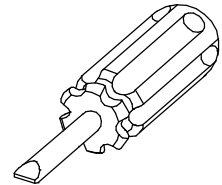
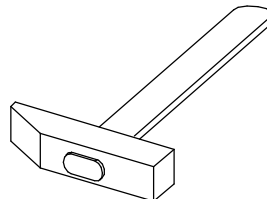
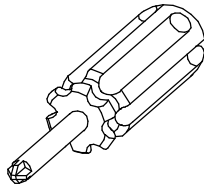
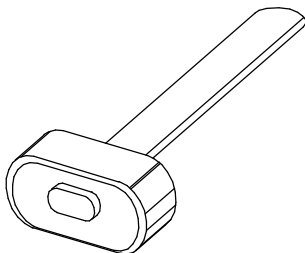
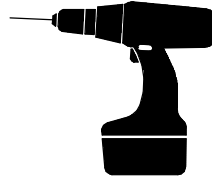
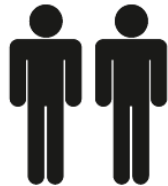
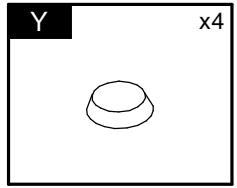
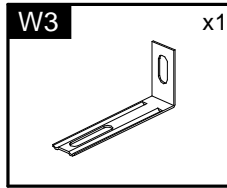
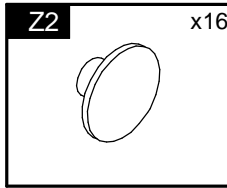
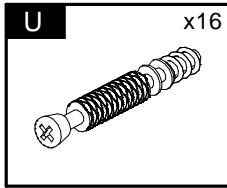
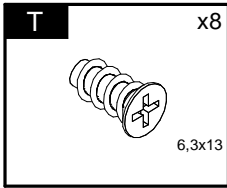
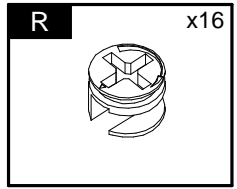
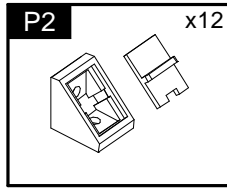
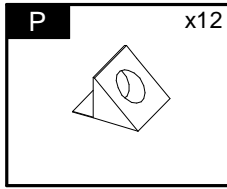
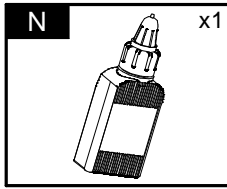
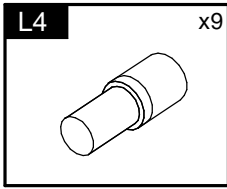
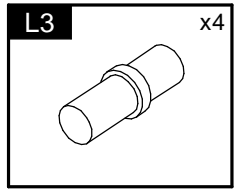
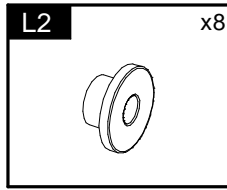
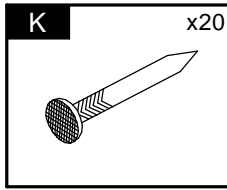
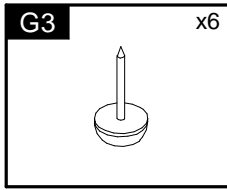
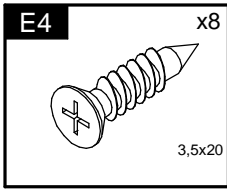
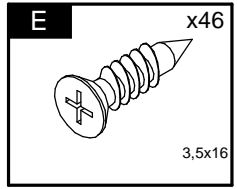
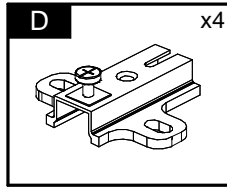
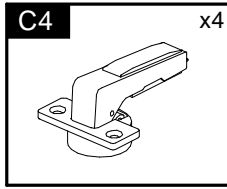
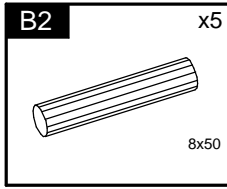
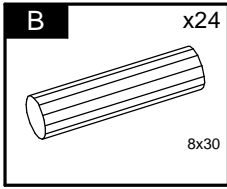
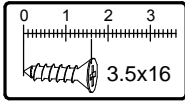

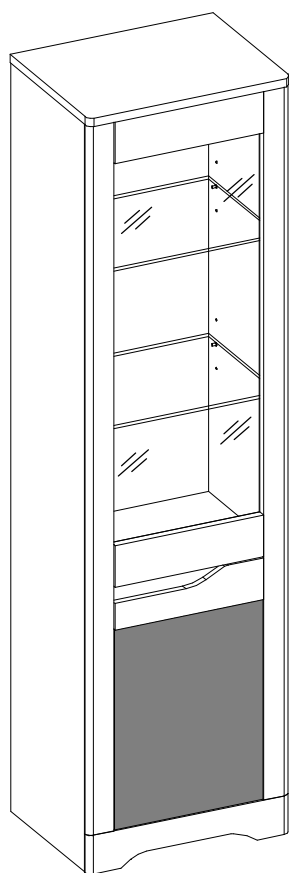

Element symbol	Measurements				Code	Paket
1	547	422	22	1	1002/2002	1/2
2	300	84	22	1	1008	1/2
3	1978	396	16	1	1003	1/2
4	1978	396	16	1	1004	1/2
5	510	382.5	16	1	1005	1/2
6	510	382	16	1	N/A	1/2
7	510	70	16	1	1025	1/2
8	510	365	16	1	1026	1/2
9	529	400	16	1	1020	1/2
10	1900	524	3	1	1030_v	1/2
11	402	112	19	1	1001/3001	1/2
12	402	112	19	1	1007/3002	1/2
13	401	111	19	1	1011_v	1/2
14	545	103	19	1	1008/3004	1/2
15	1878	72	19	1	1005/3005	1/2
16	1878	72	19	1	1005/3006	1/2
17	1068	398	4	1	Glass	2/2
18	510	370	4	2	Glass	2/2

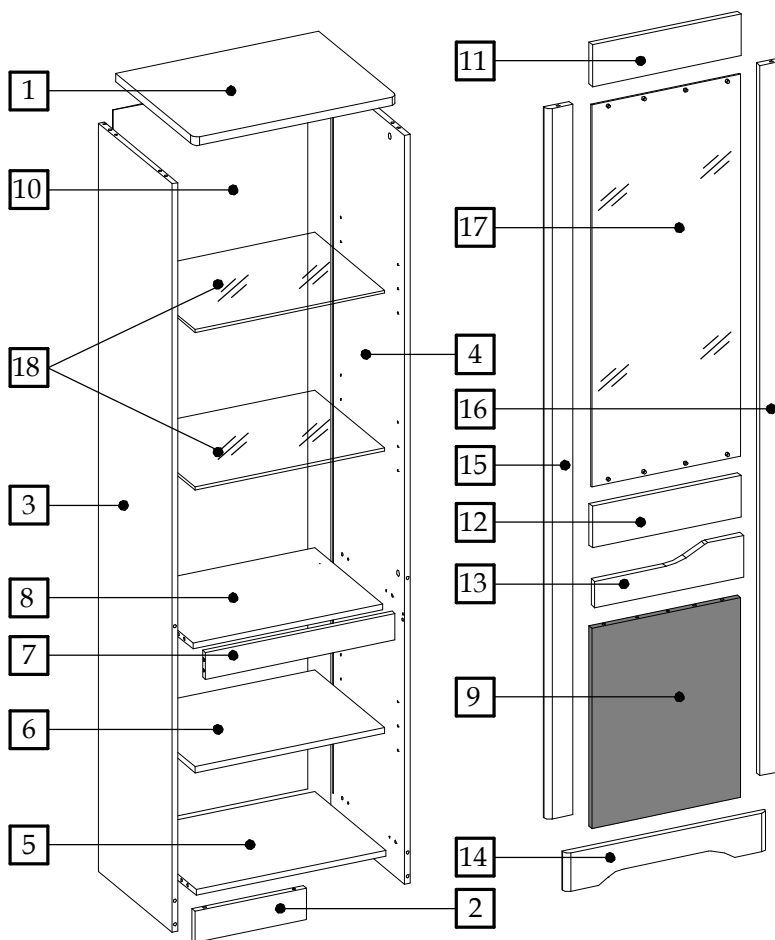

2

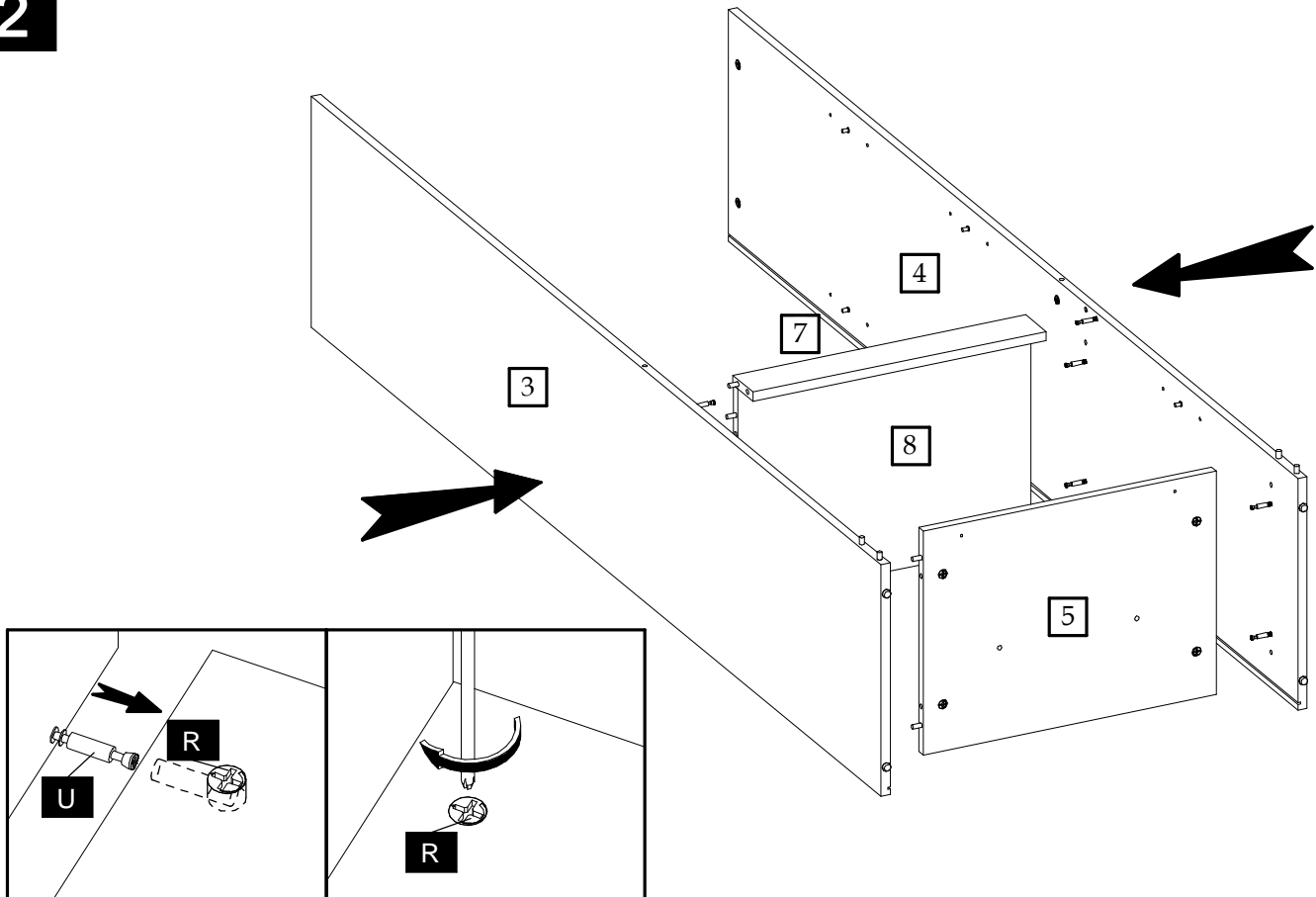

3

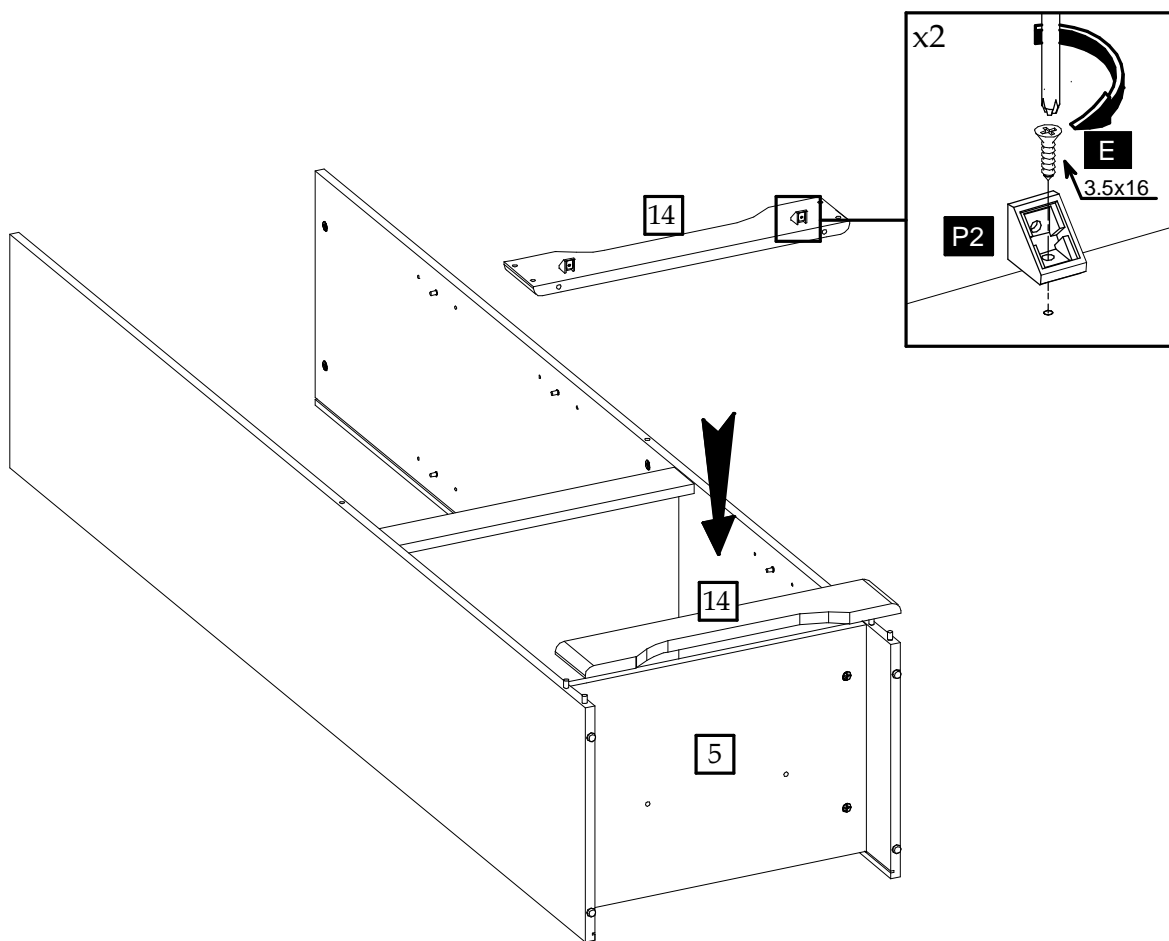

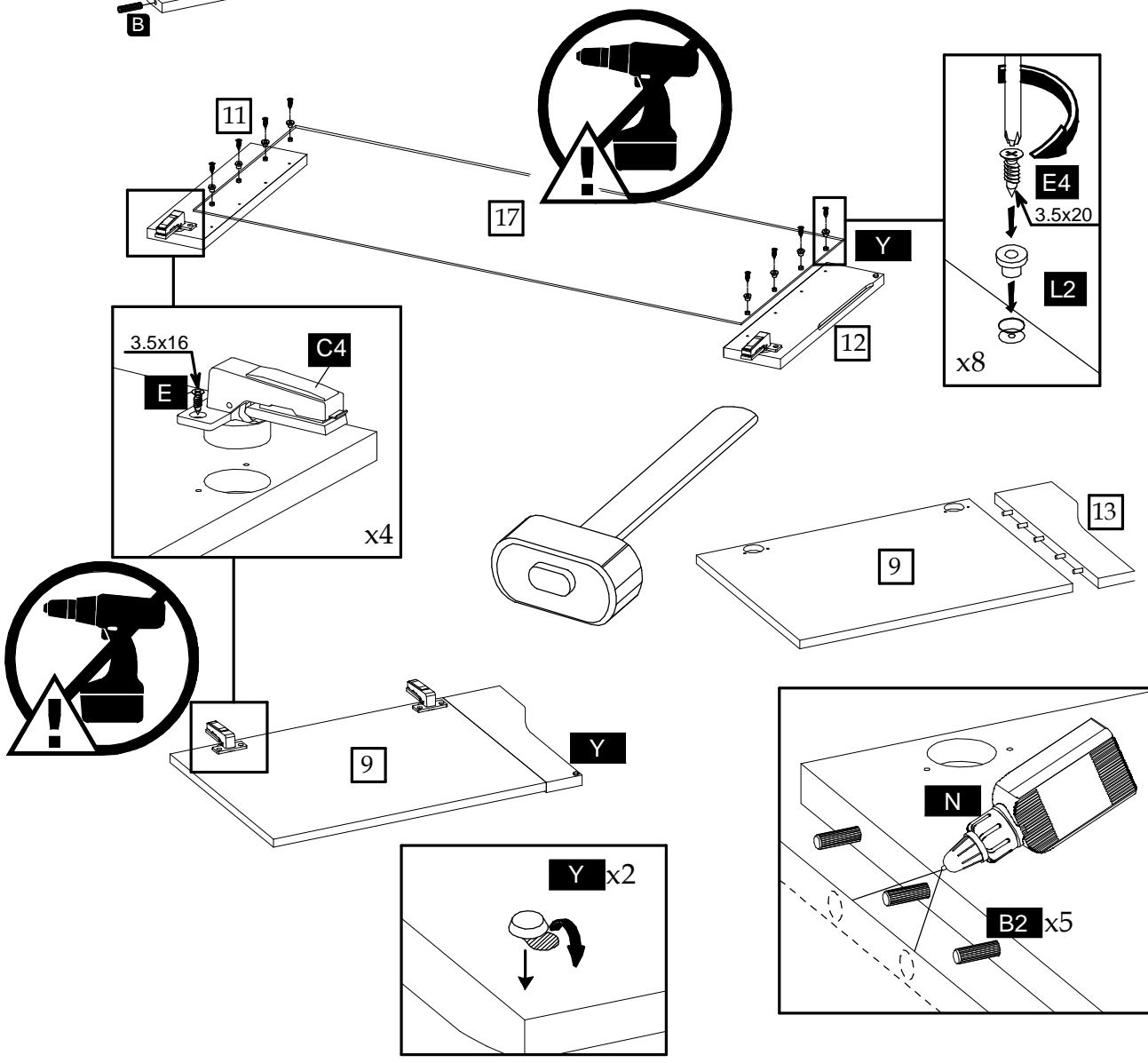
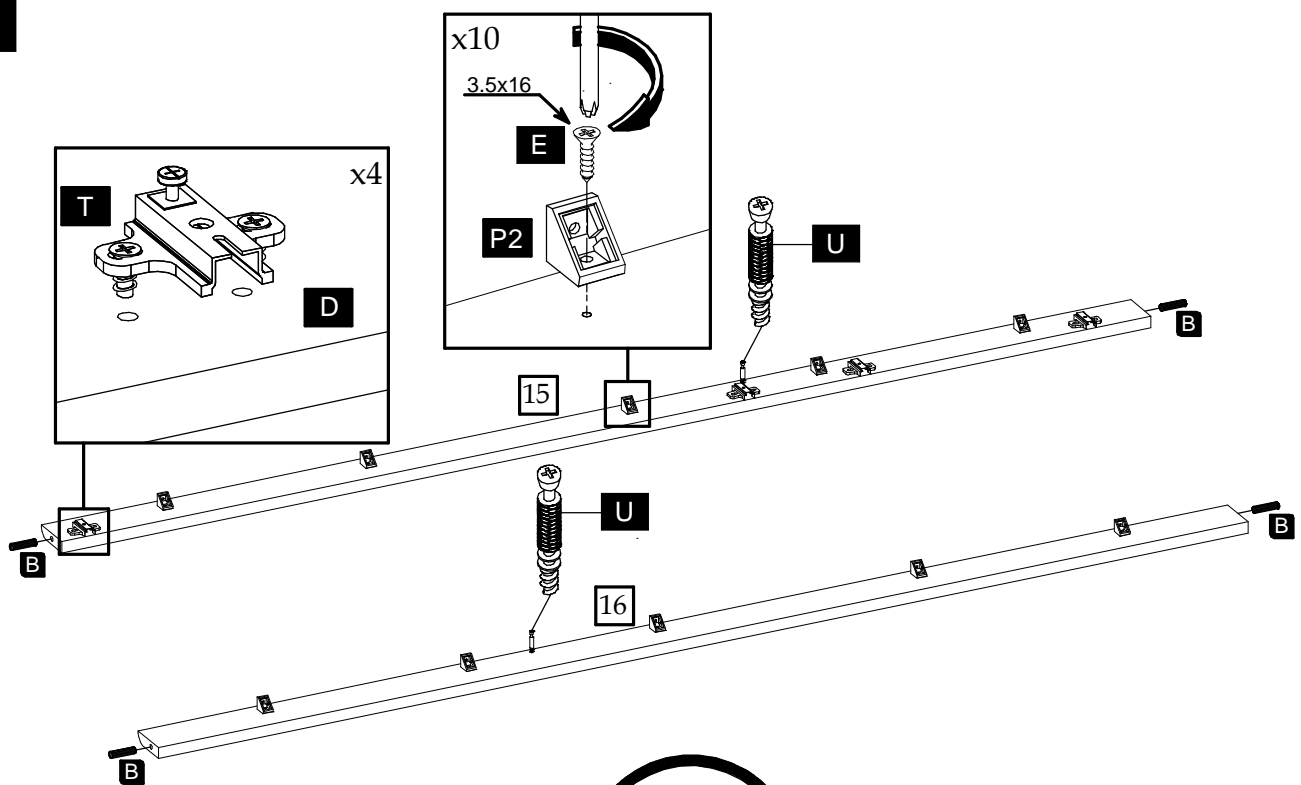

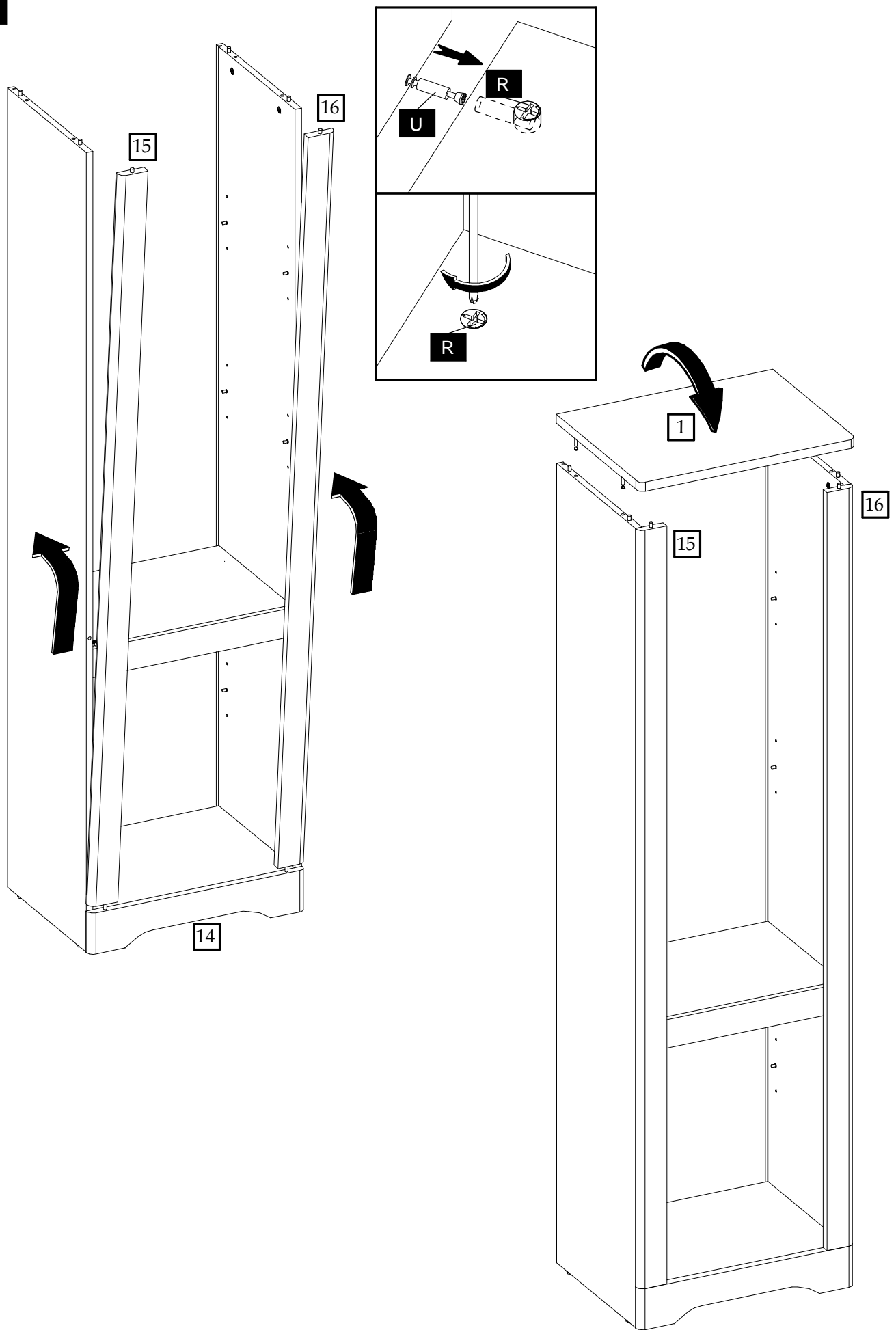

6

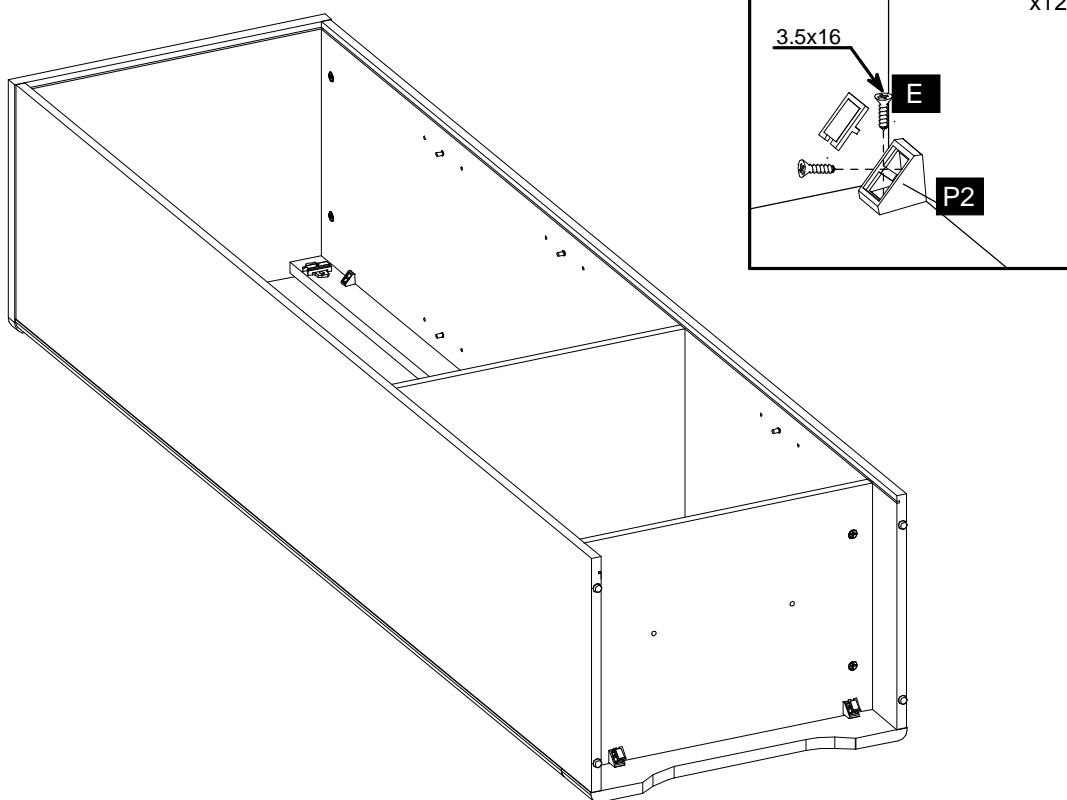

7

