

FIDEL

Typ R1

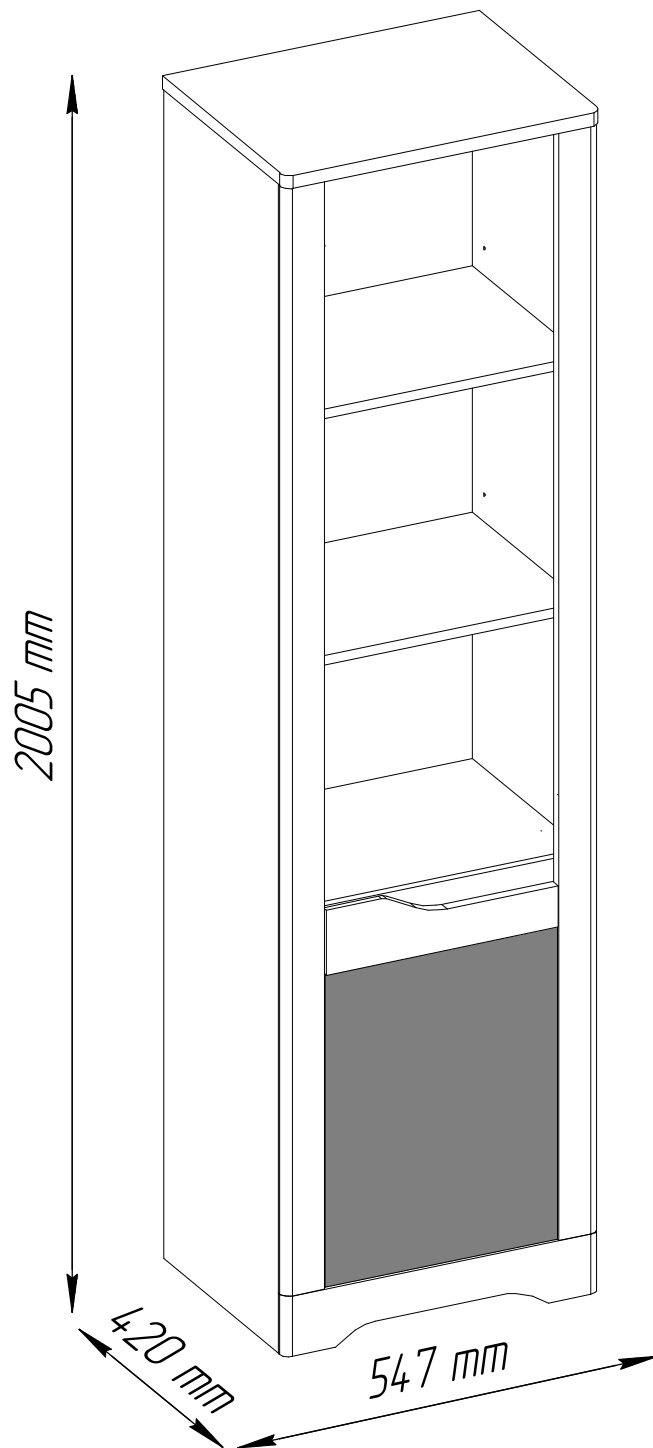

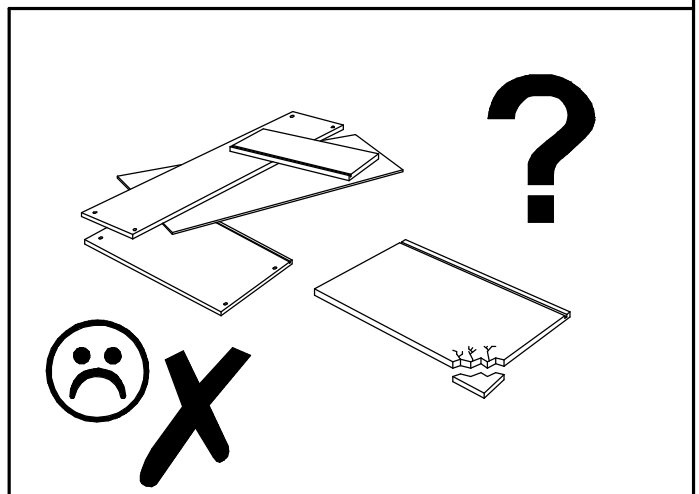

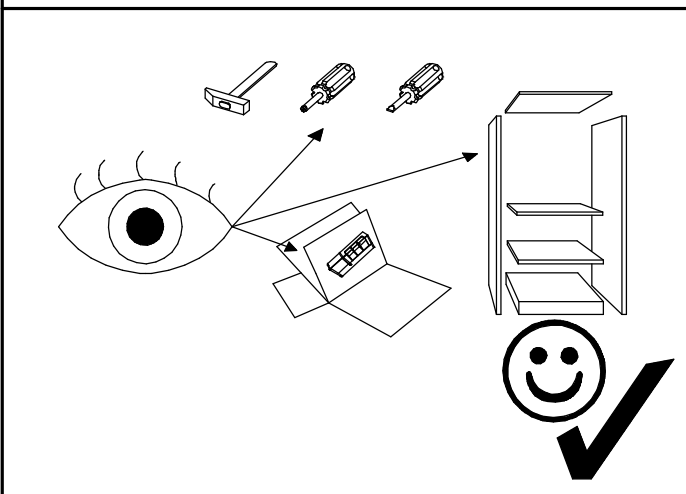
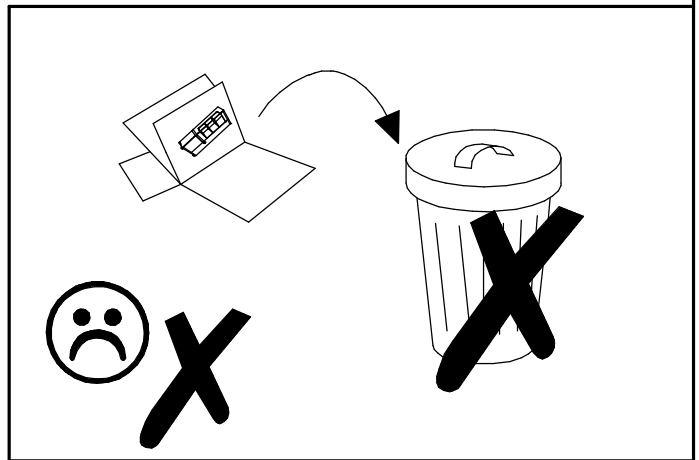
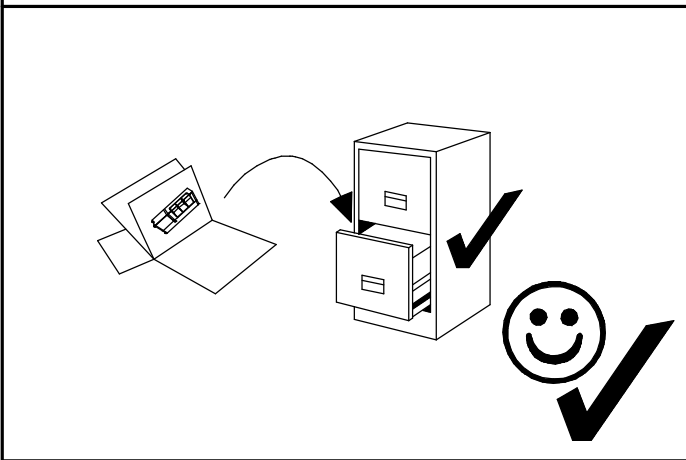
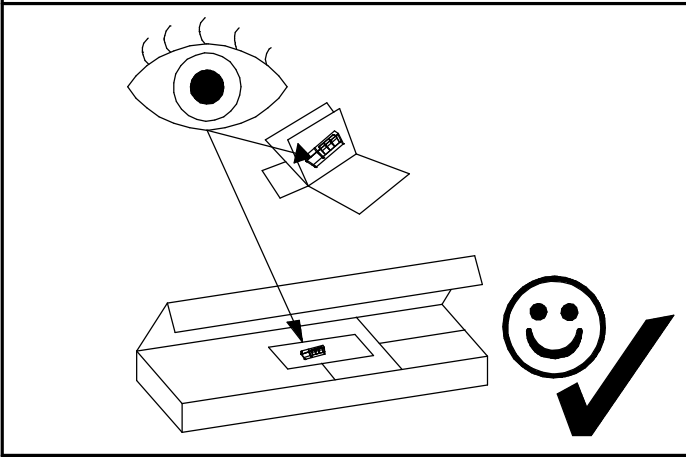
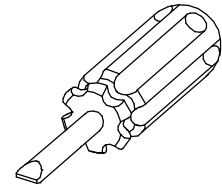
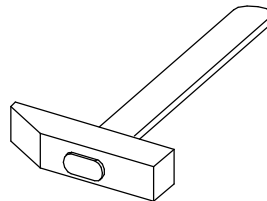
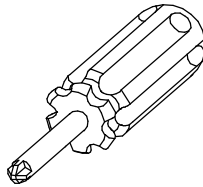
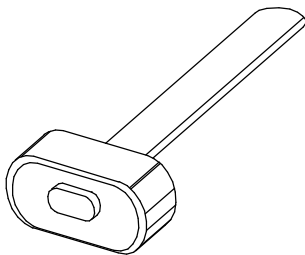
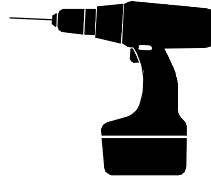
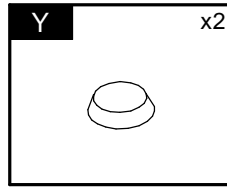
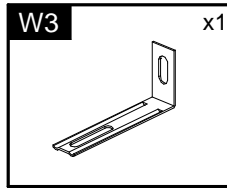
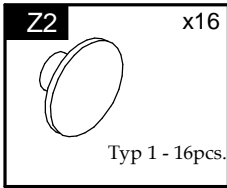
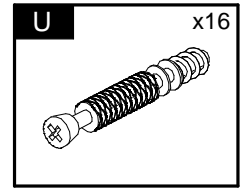
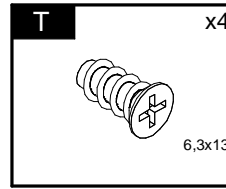
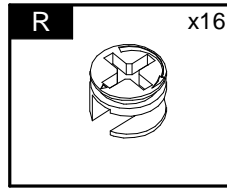
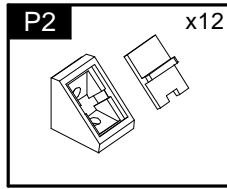
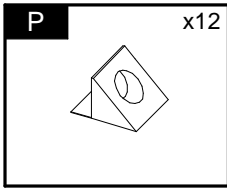
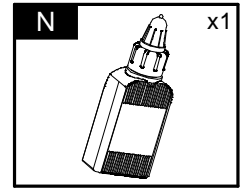
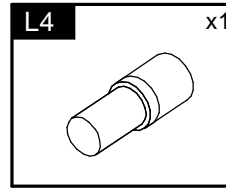
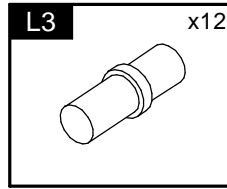
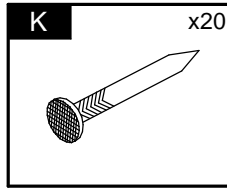
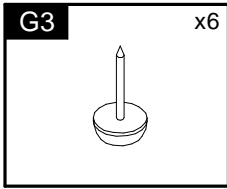
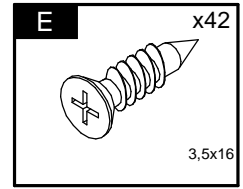
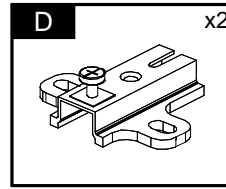
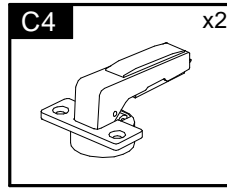
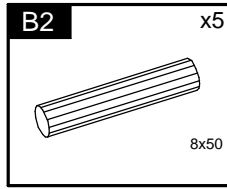
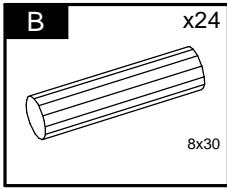
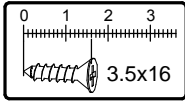
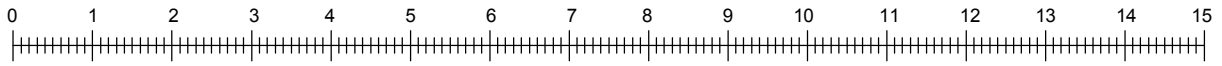

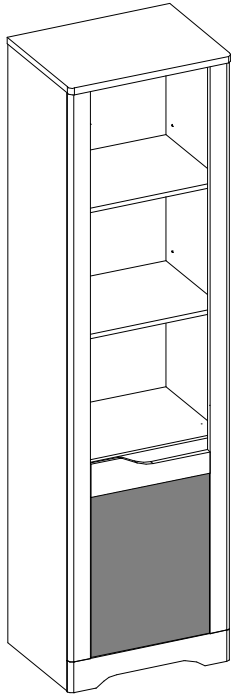

Element symbol	Measurements				Code	Paket
1	547	422	22	1	1002/2002	1/1
2	300	84	22	1	1008	1/1
3	1978	396	16	1	1003	1/1
4	1978	396	16	1	1004	1/1
5	510	382.5	16	1	1005	1/1
6	510	382	16	1	N/A	1/1
7	510	382	16	1	N/A	1/1
8	510	382	16	1	N/A	1/1
9	510	70	16	1	1025	1/1
10	510	365	16	1	1026	1/1
11	529	400	16	1	1020	1/1
12	1900	524	3	1	1030_v	1/1
13	401	111	19	1	1002_v	1/1
14	545	103	19	1	1008/3001	1/1
15	1878	72	19	1	1005/3002	1/1
16	1878	72	19	1	1005/3003	1/1

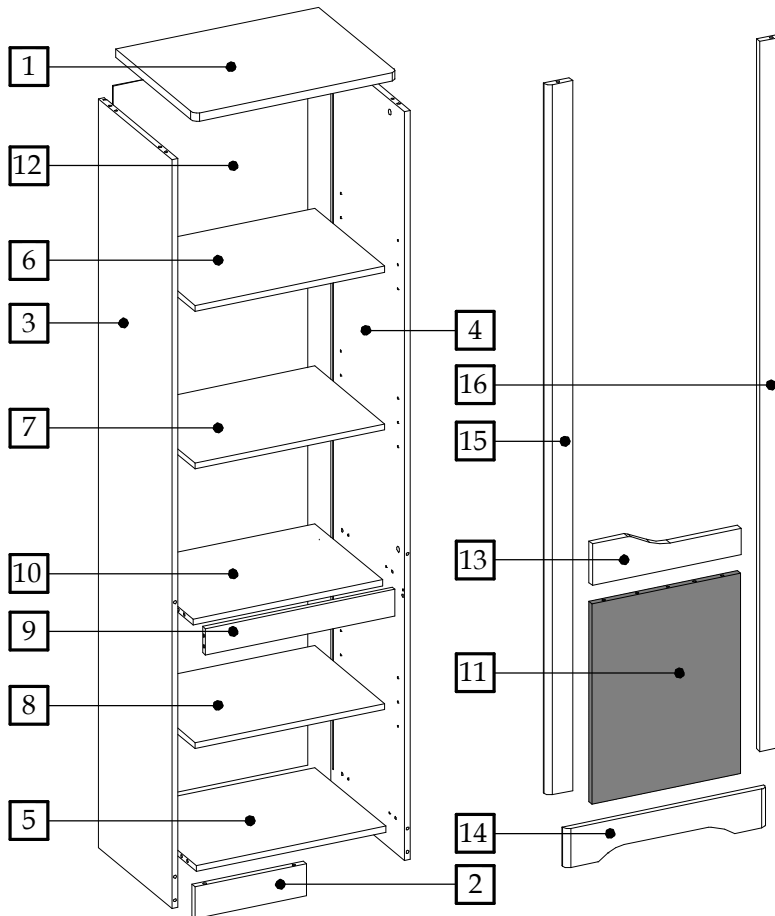

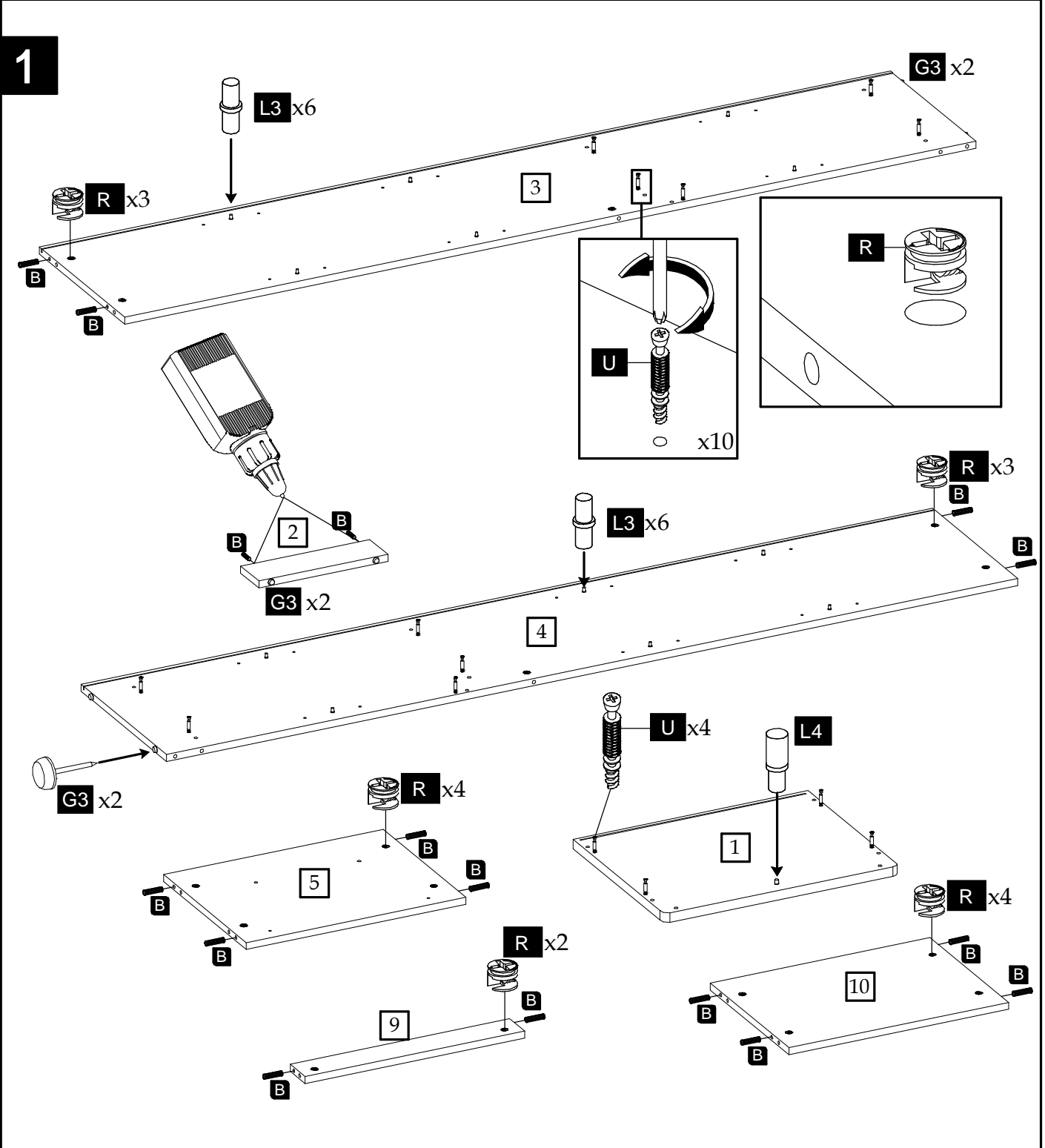

2

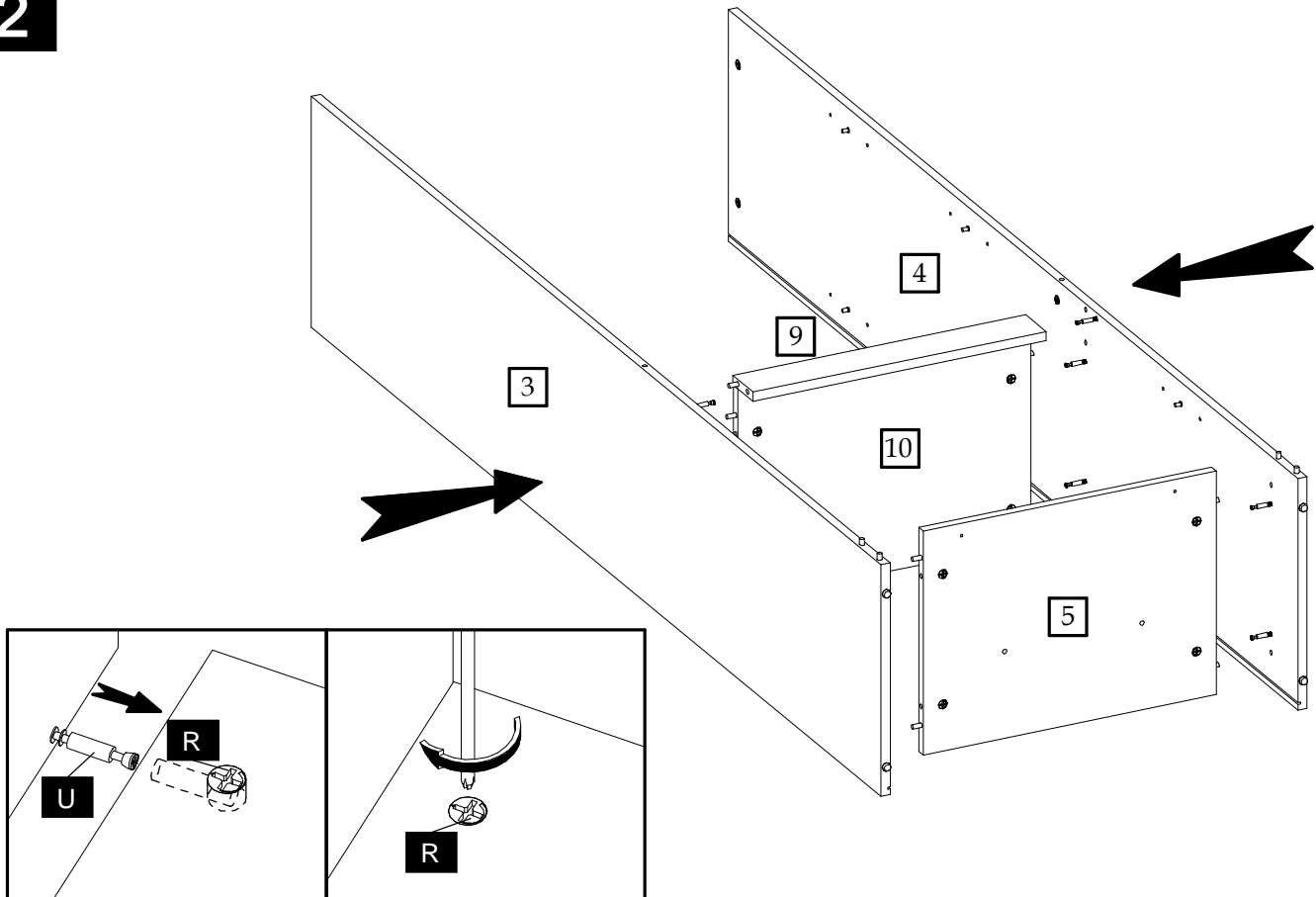

3

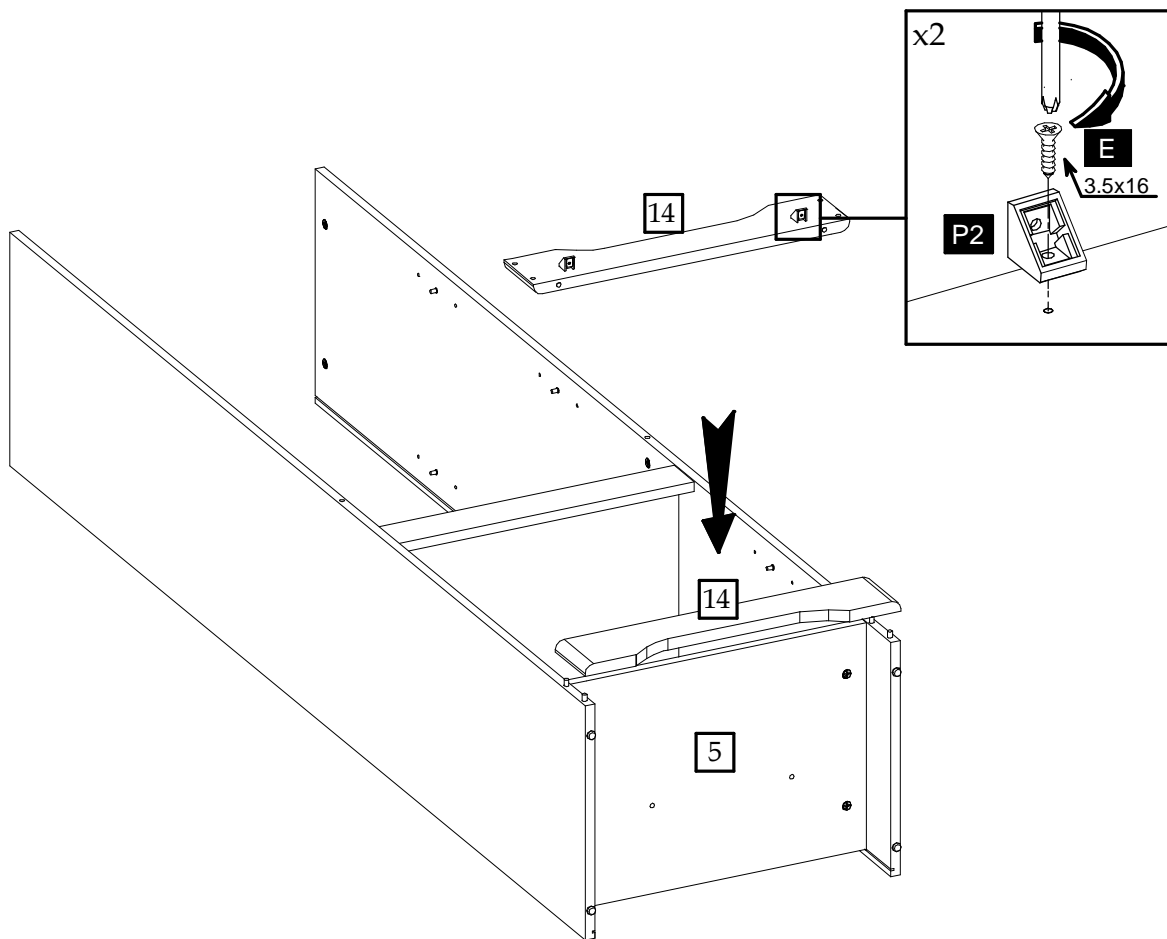

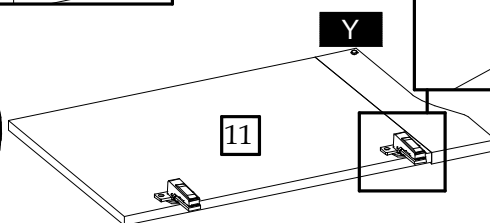
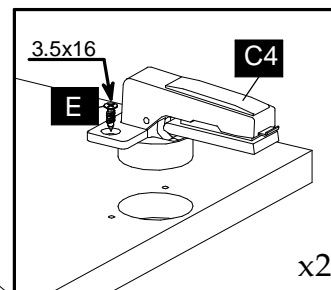
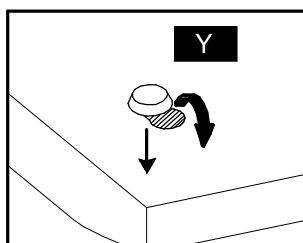
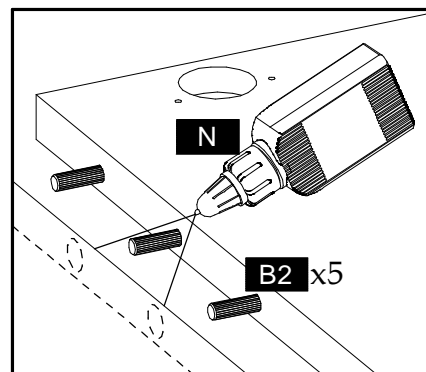
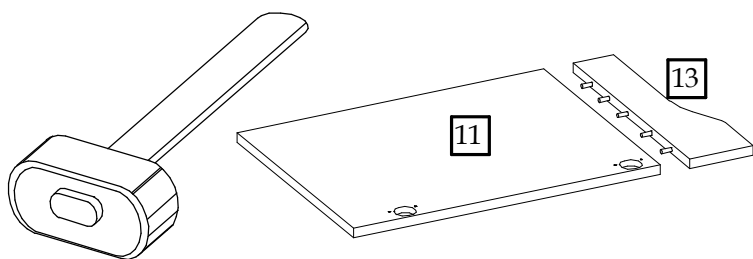
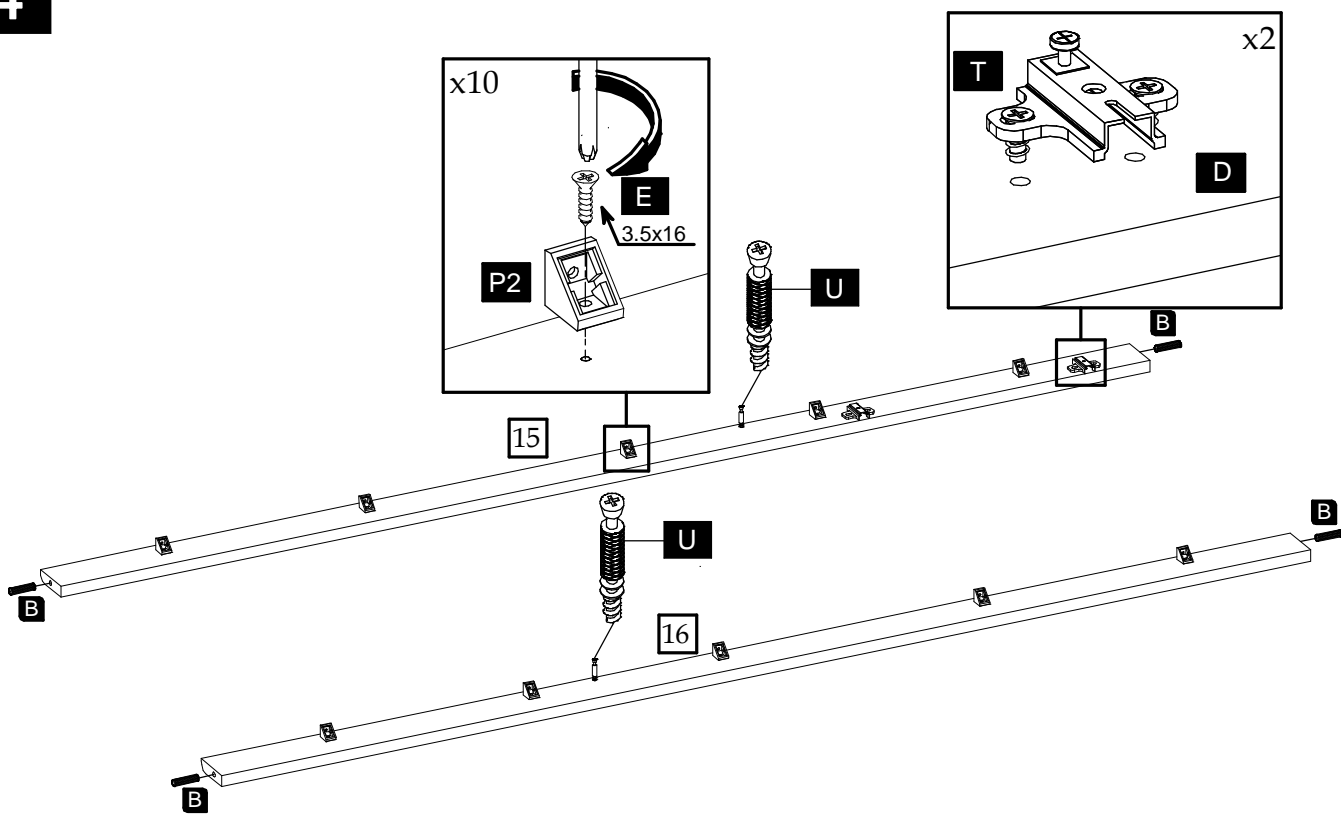

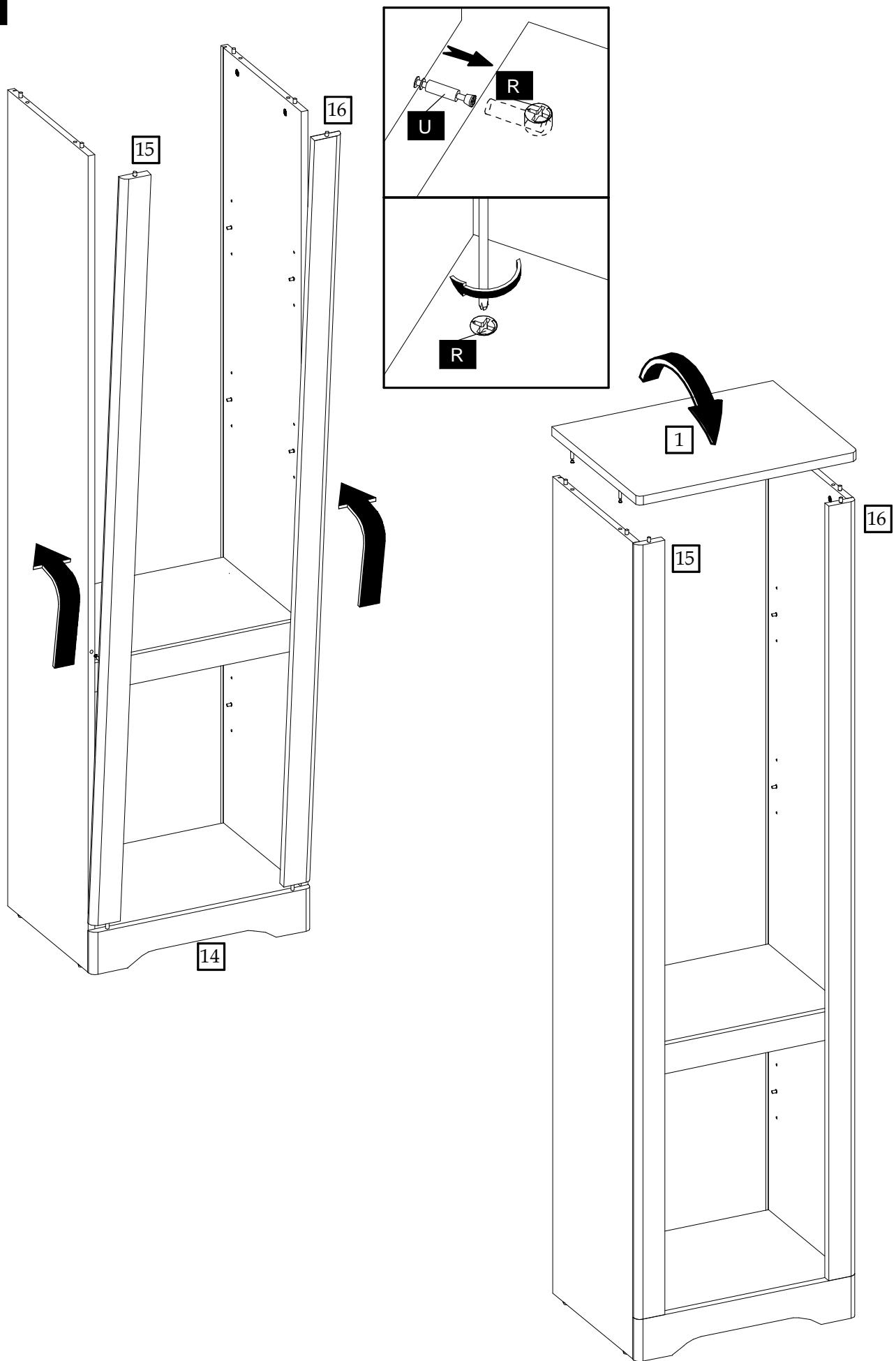

6

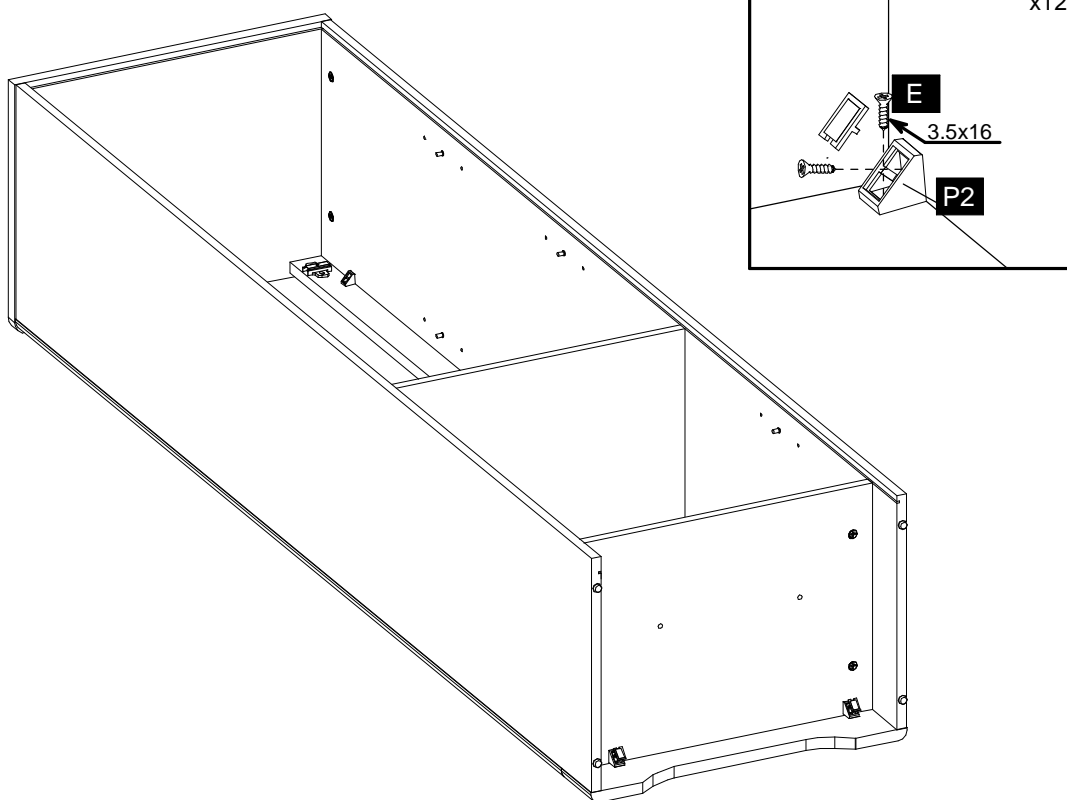

7

