

# FIDEL

## Typ V1

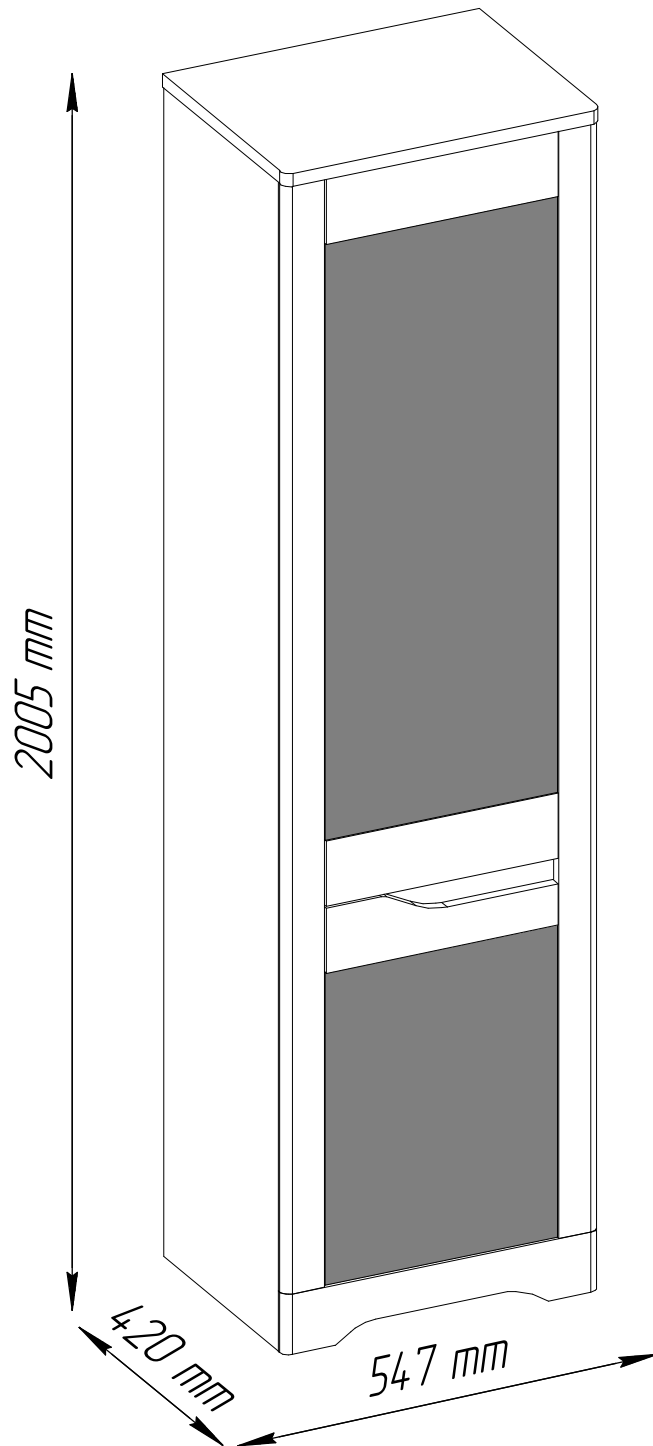

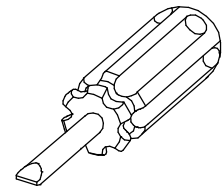

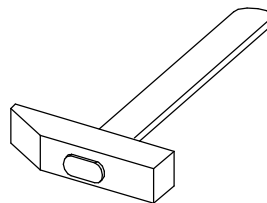
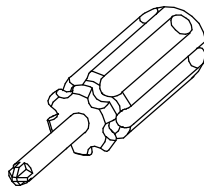
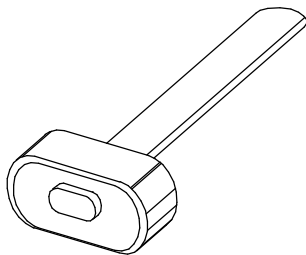
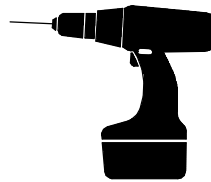
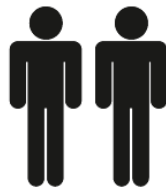
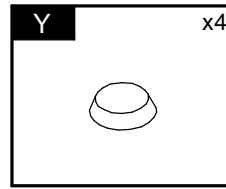
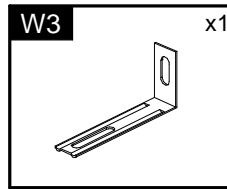
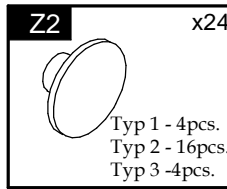
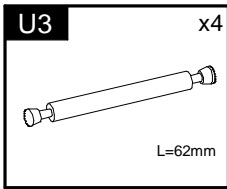
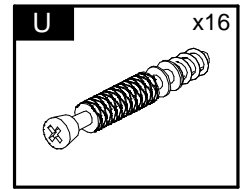
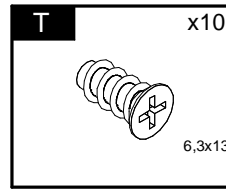
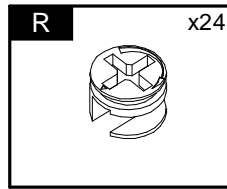
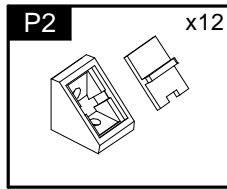
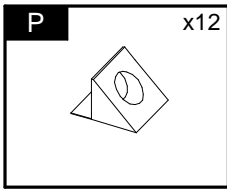
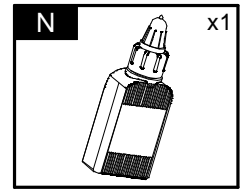
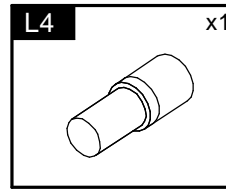
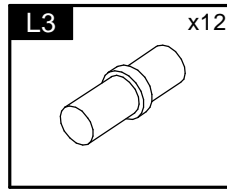
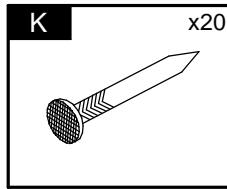
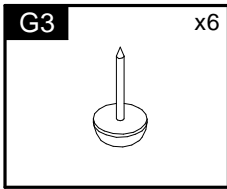
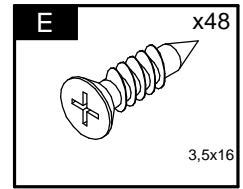
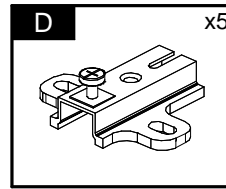
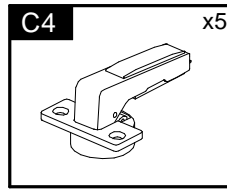
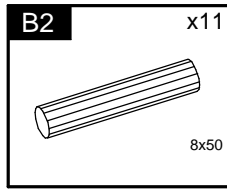
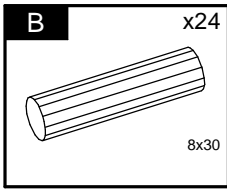

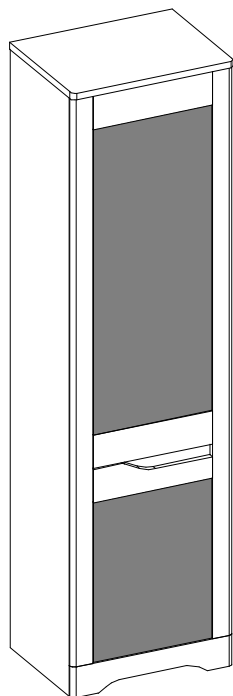

Element symbol	Measurements				Code	Paket
	1	2	3	4		
1	547	422	22	1	1002/2002	1/2
2	300	84	22	1	1008	1/2
3	1978	396	16	1	1003	1/2
4	1978	396	16	1	1004	1/2
5	510	382.5	16	1	1005	1/2
6	510	382	16	1	N/A	1/2
7	510	382	16	1	N/A	1/2
8	510	382	16	1	N/A	1/2
9	510	70	16	1	1025	1/2
10	510	365	16	1	1026	1/2
11	529	400	16	1	1020	2/2
12	1009	400	16	1	1021	2/2
13	1900	524	3	1	N/A	1/2
14	402	112	19	1	1001/3001	2/2
15	402	112	19	1	1006/3002	1/2
16	401	111	19	1	1002_v	2/2
17	545	103	19	1	1008/3004	1/2
18	1878	72	19	1	1005/3005	1/2
19	1878	72	19	1	1005/3006	1/2

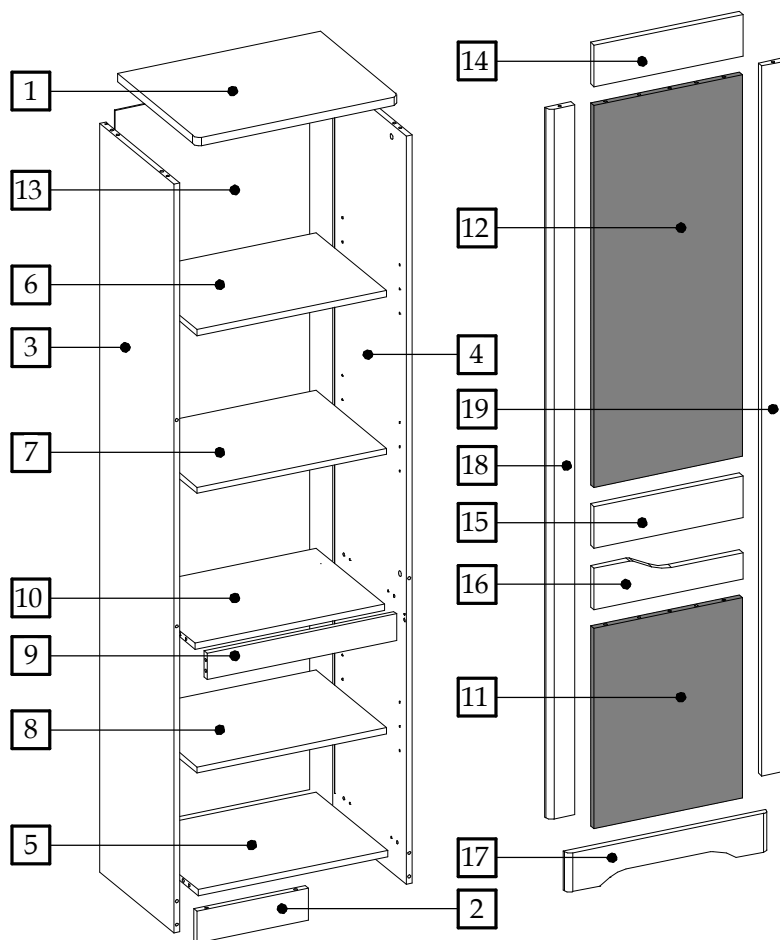

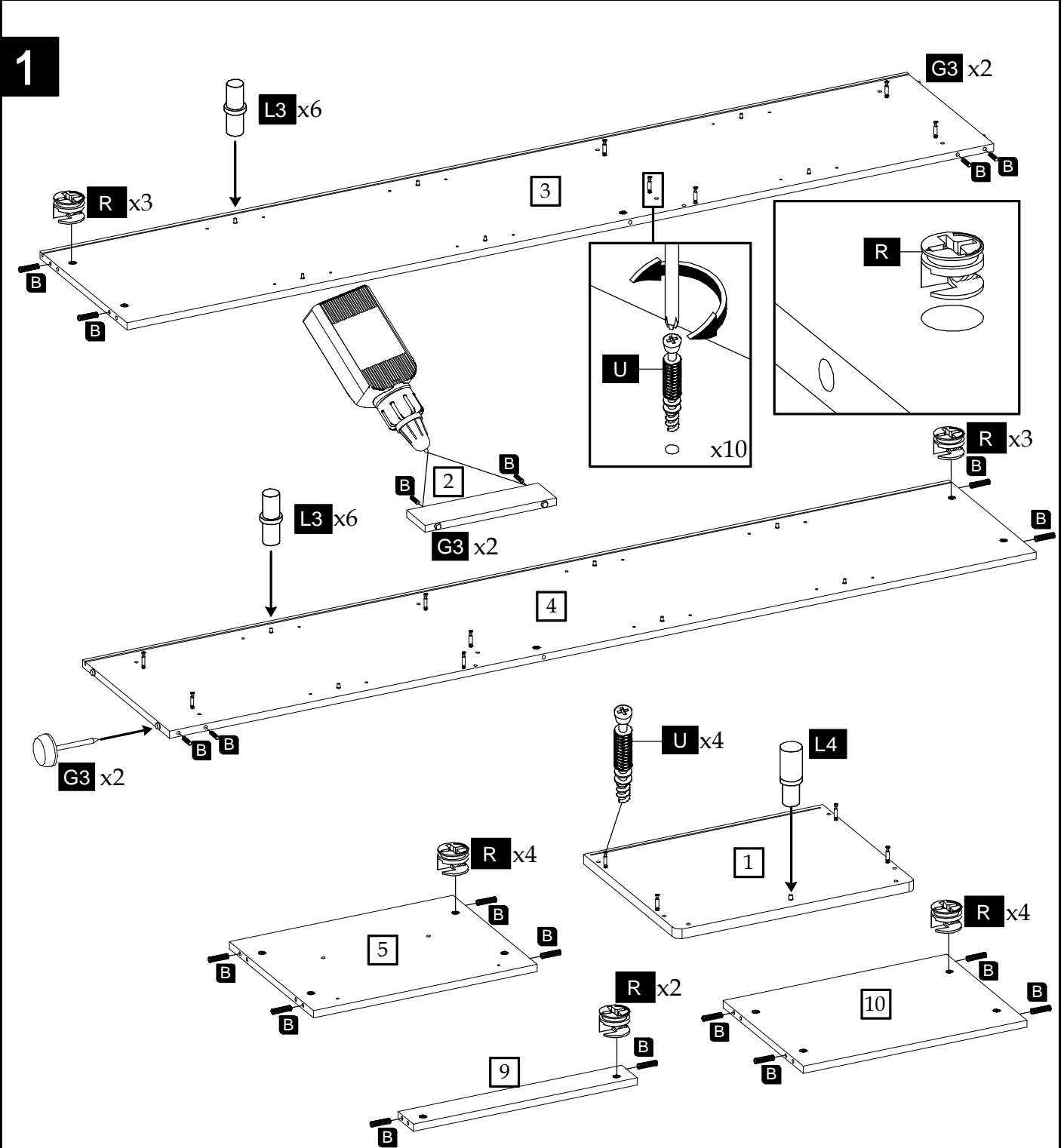
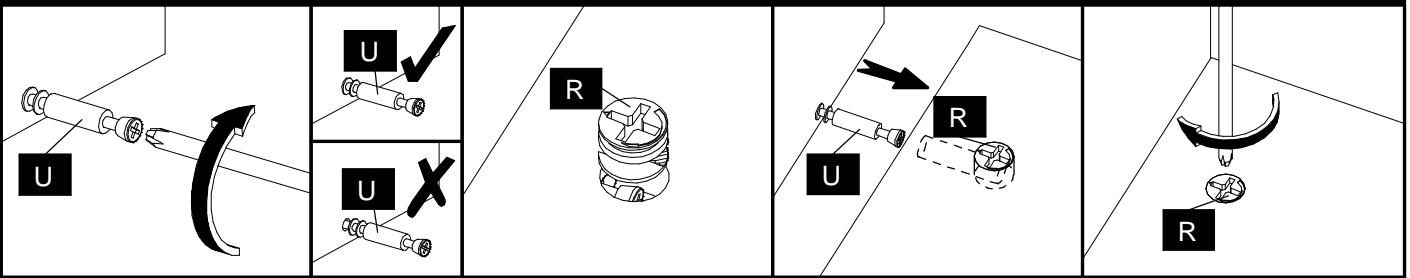

2

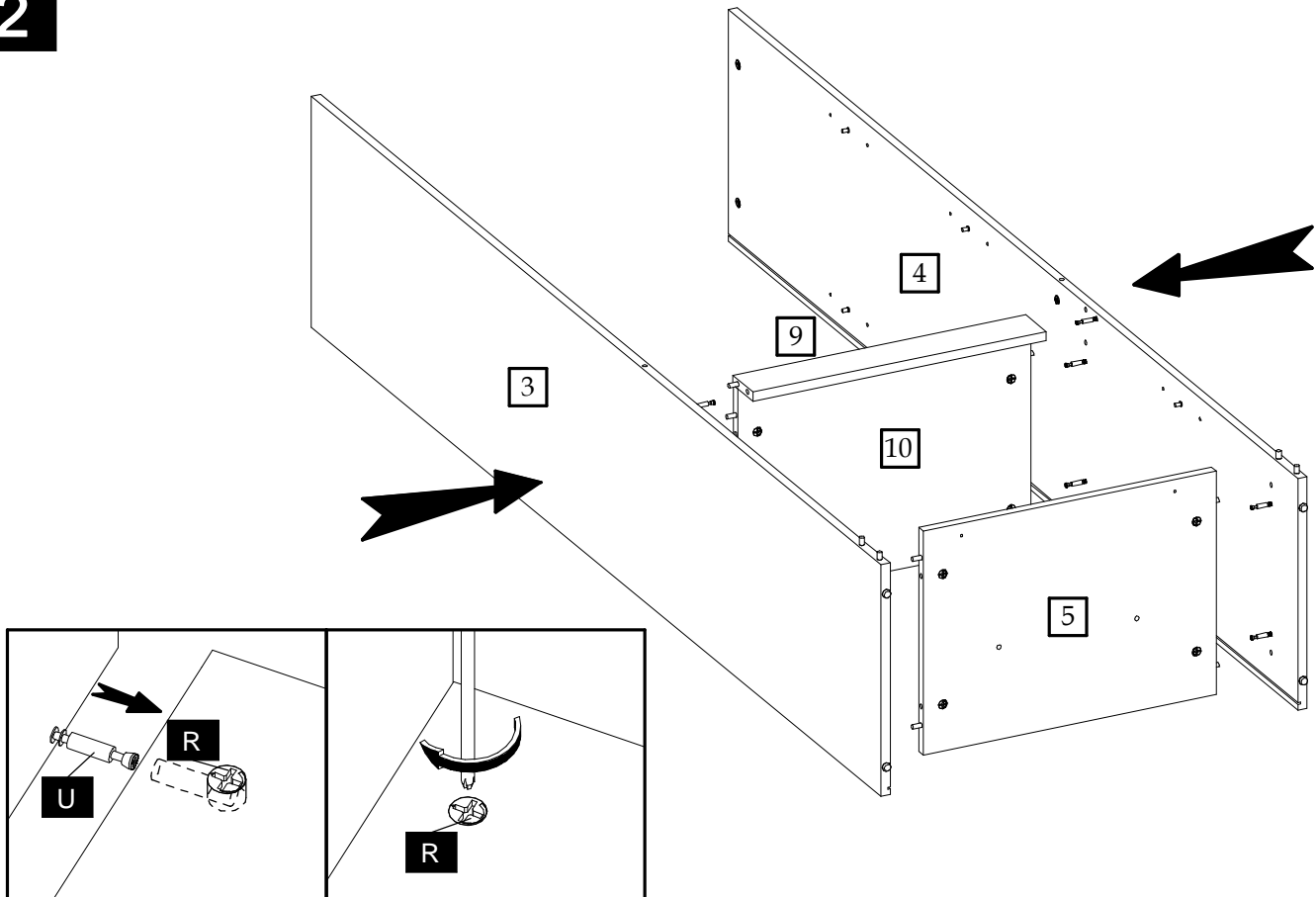

3

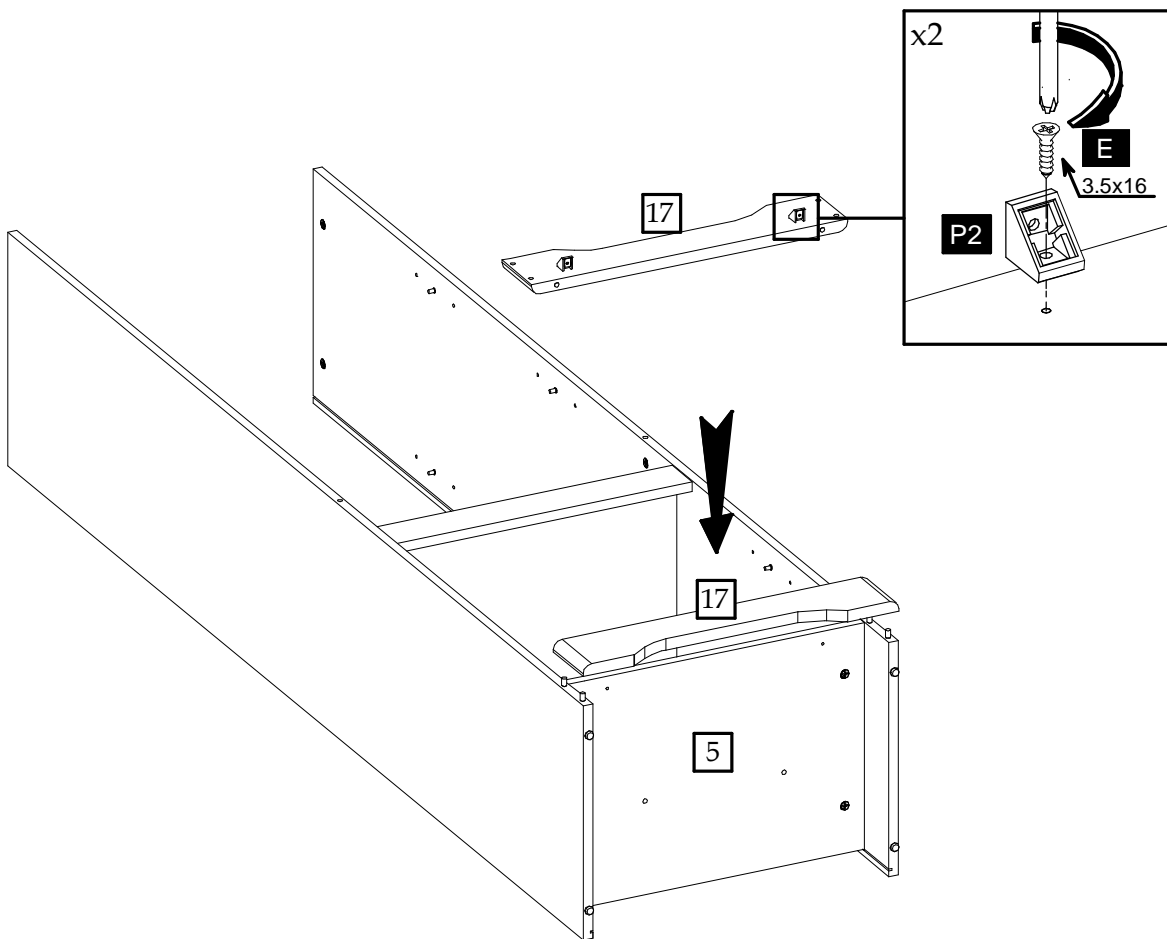

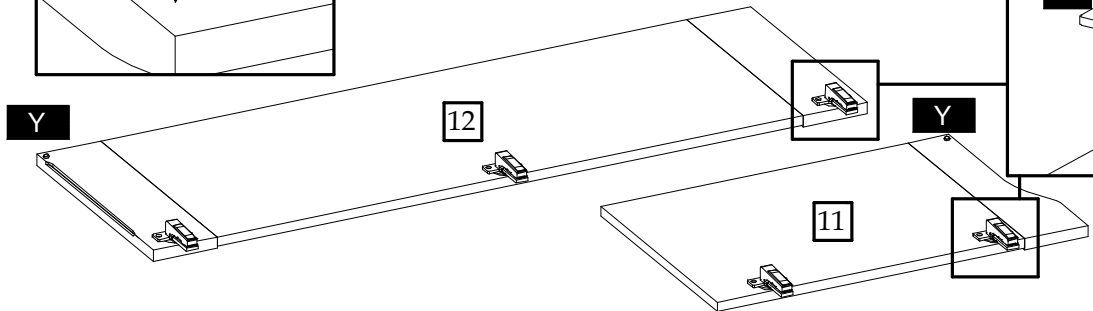
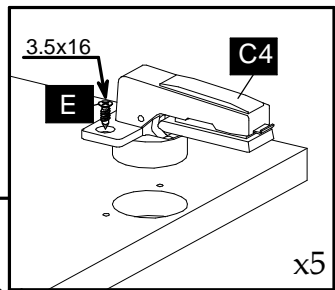
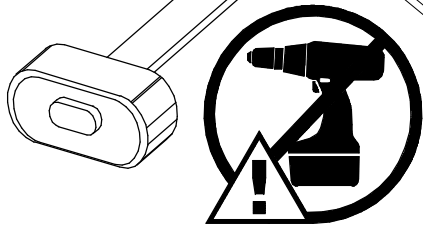
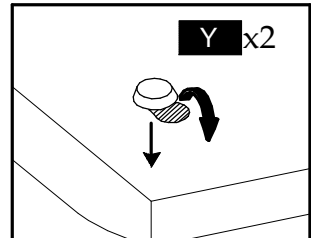
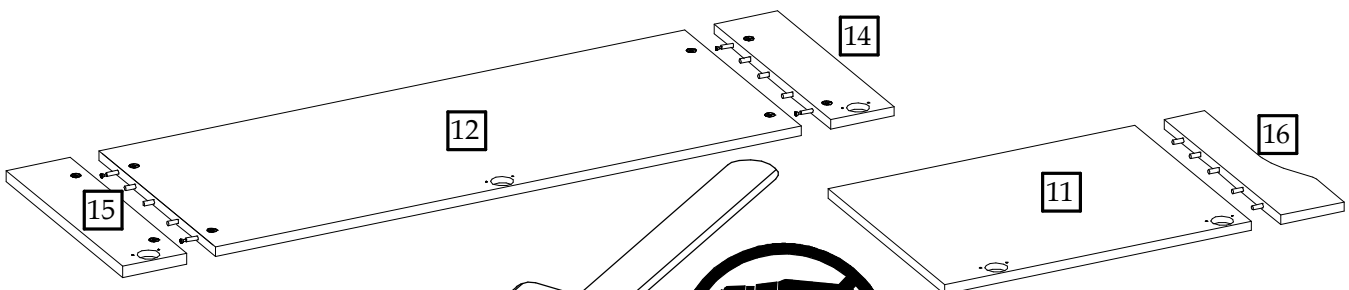
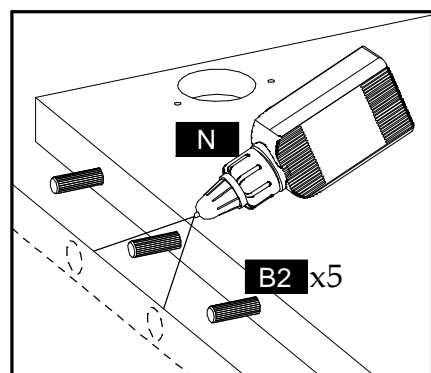
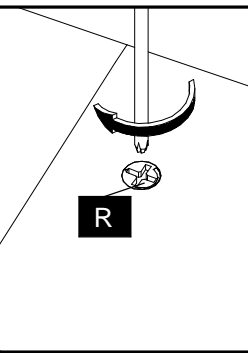
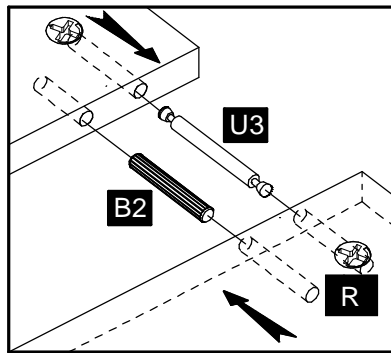
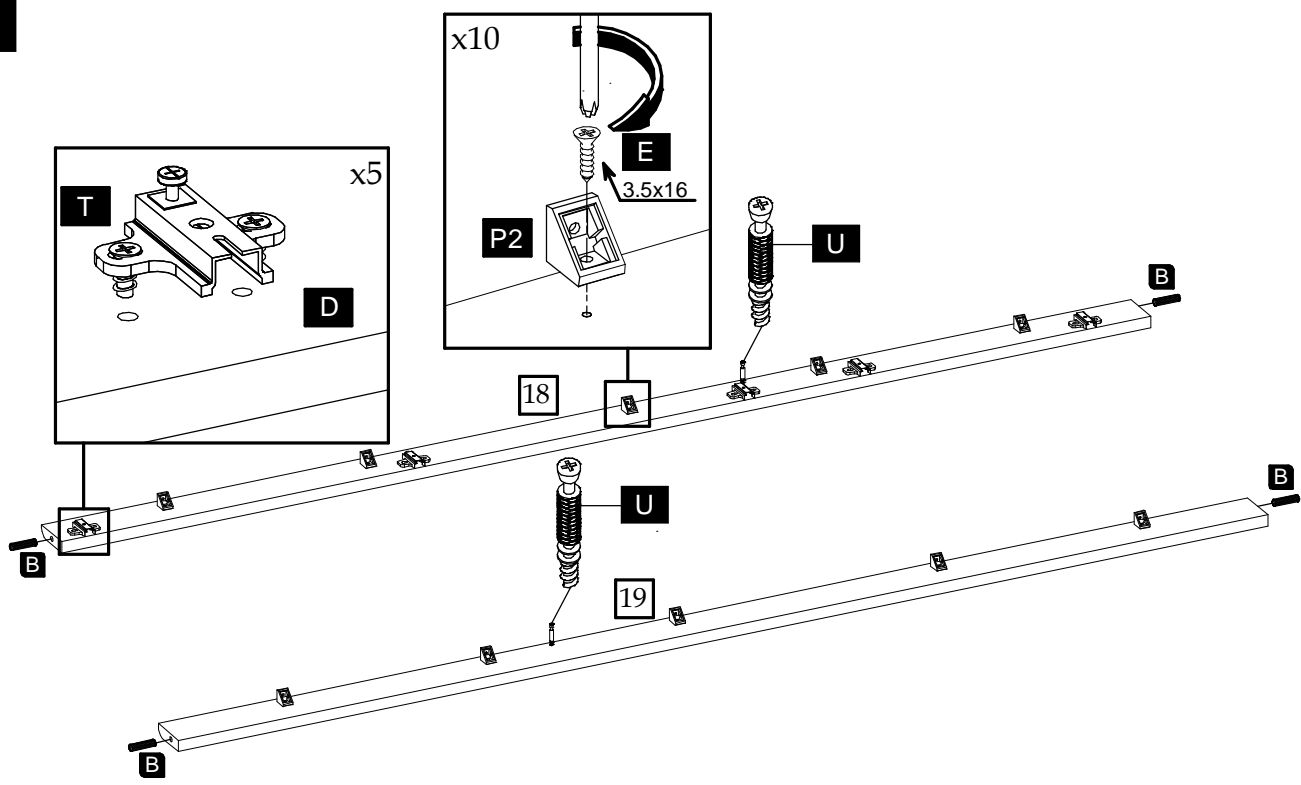

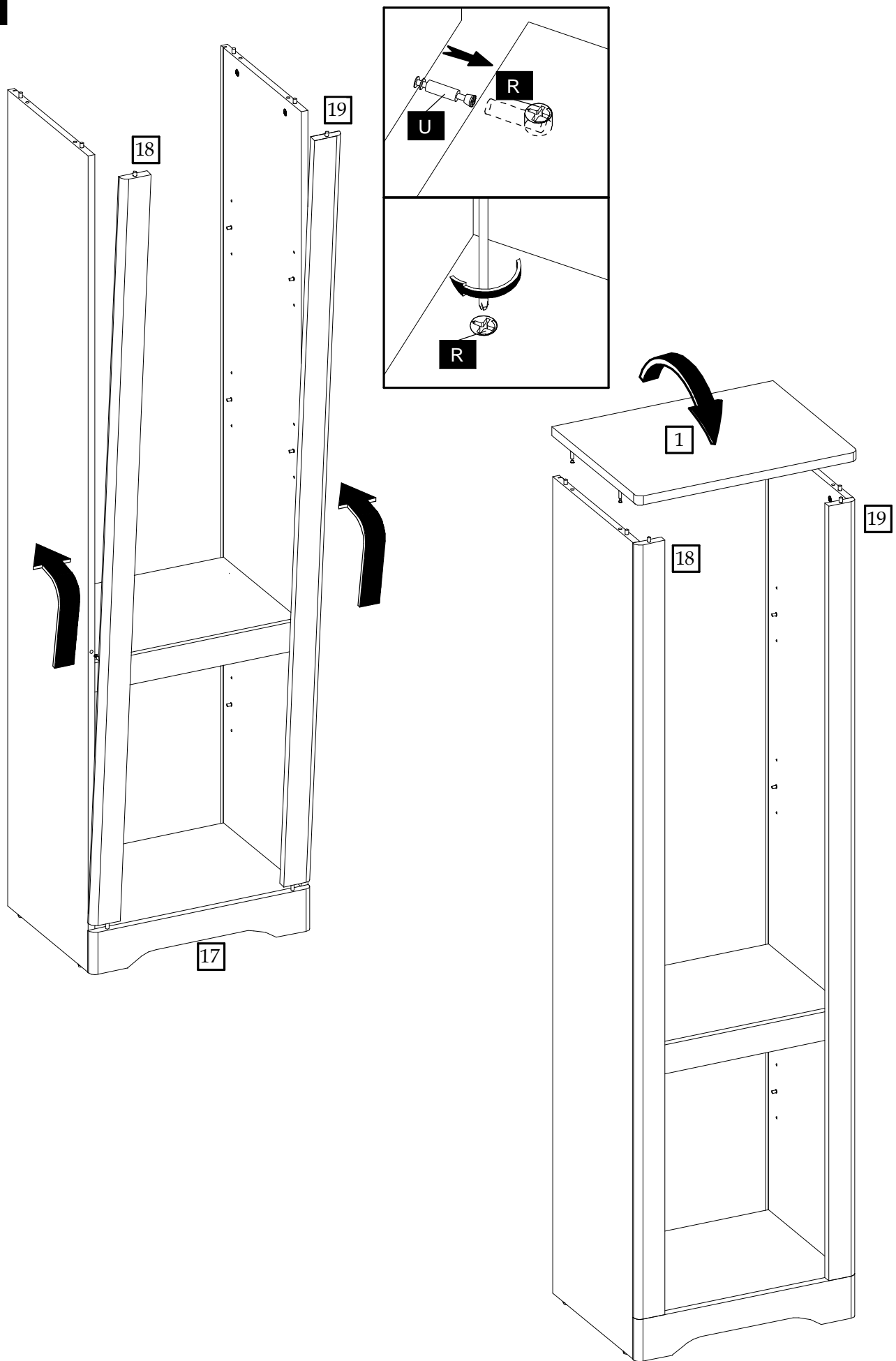



6

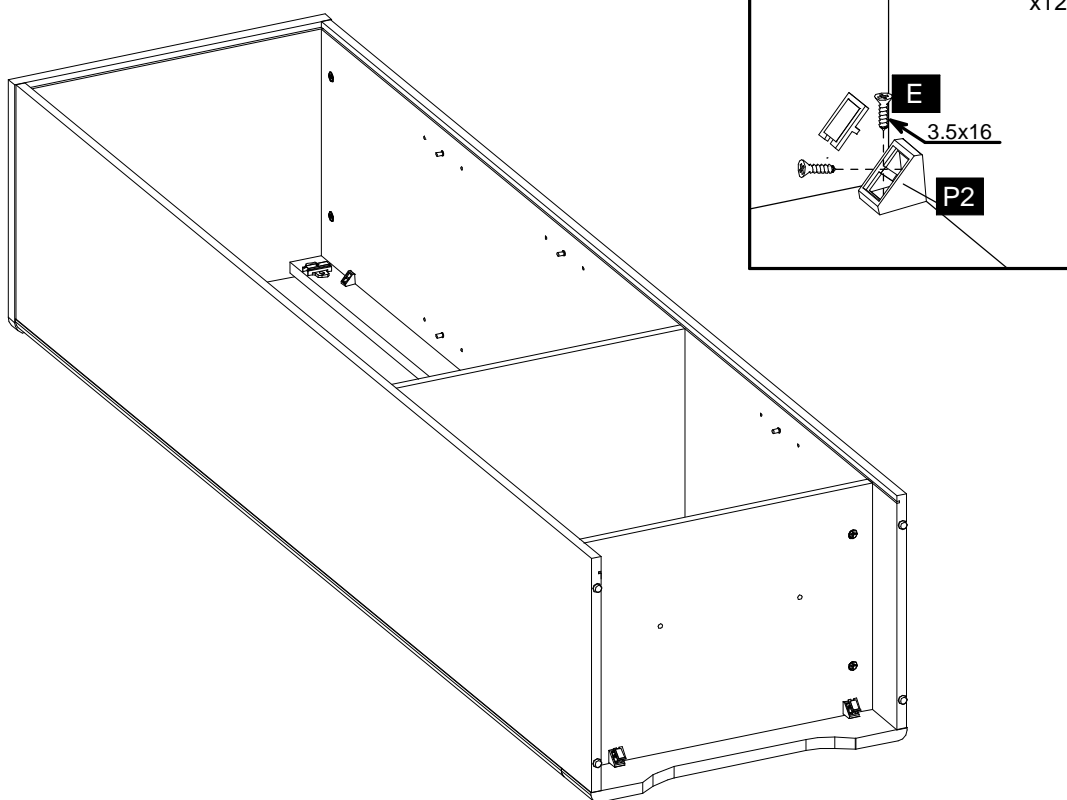

7

