

FIDEL

Typ H

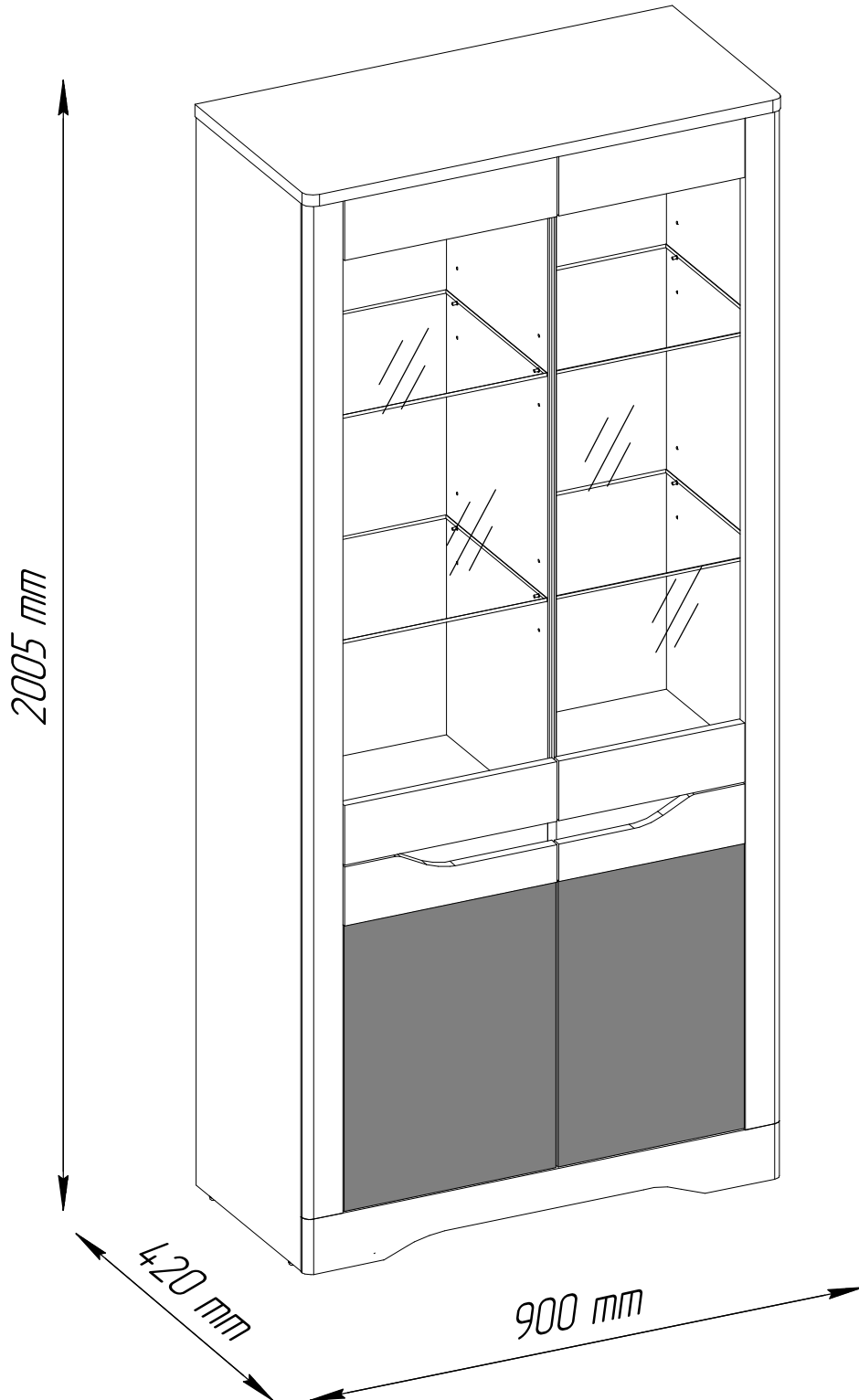

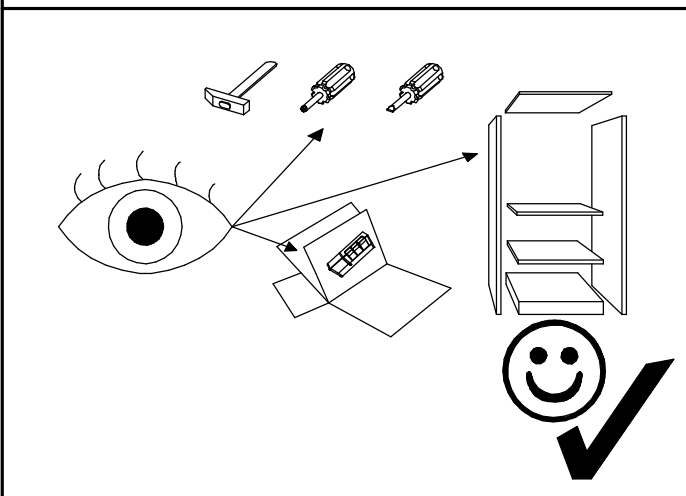

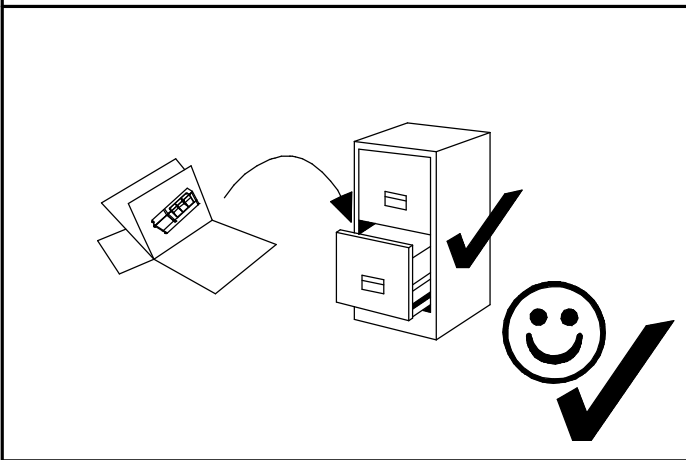
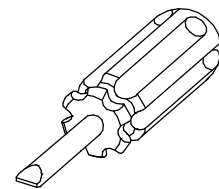
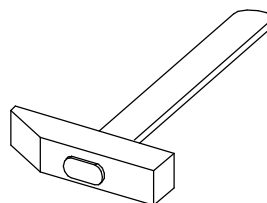
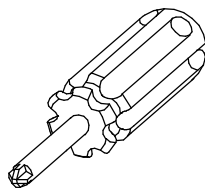
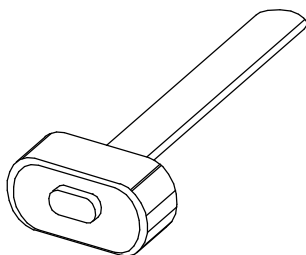
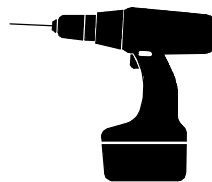
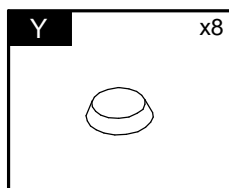
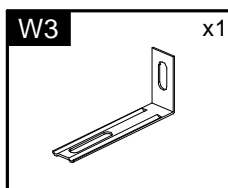
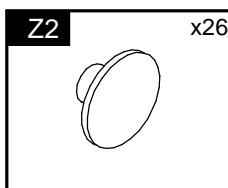
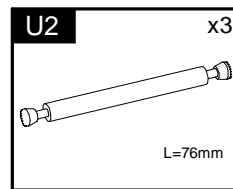
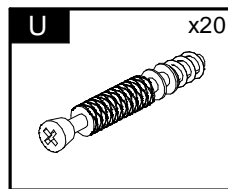
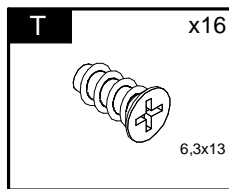
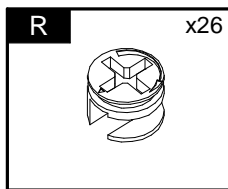
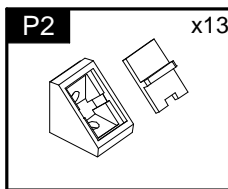
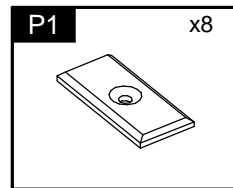
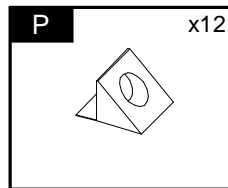
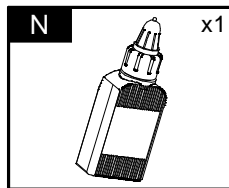
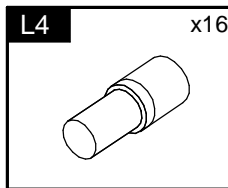
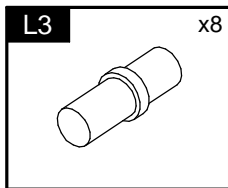
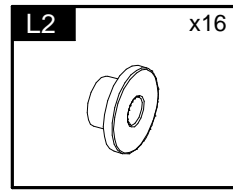
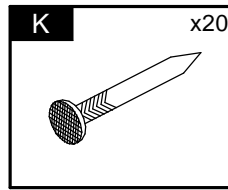
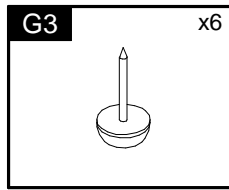
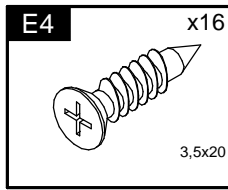
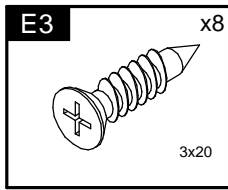
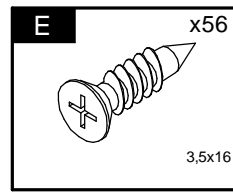
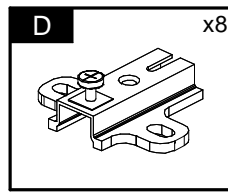
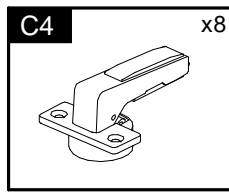
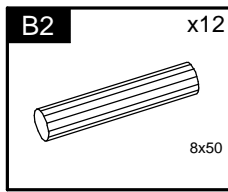
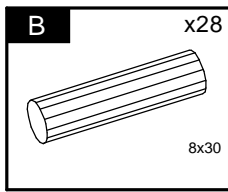
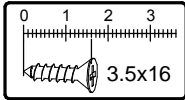

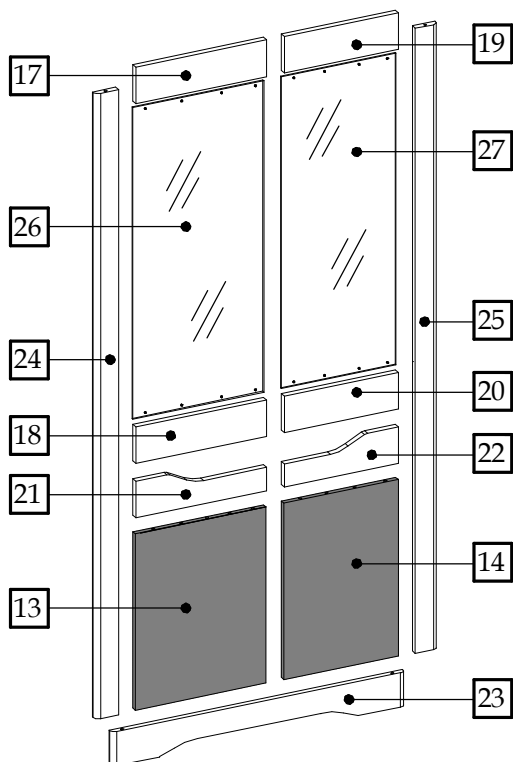
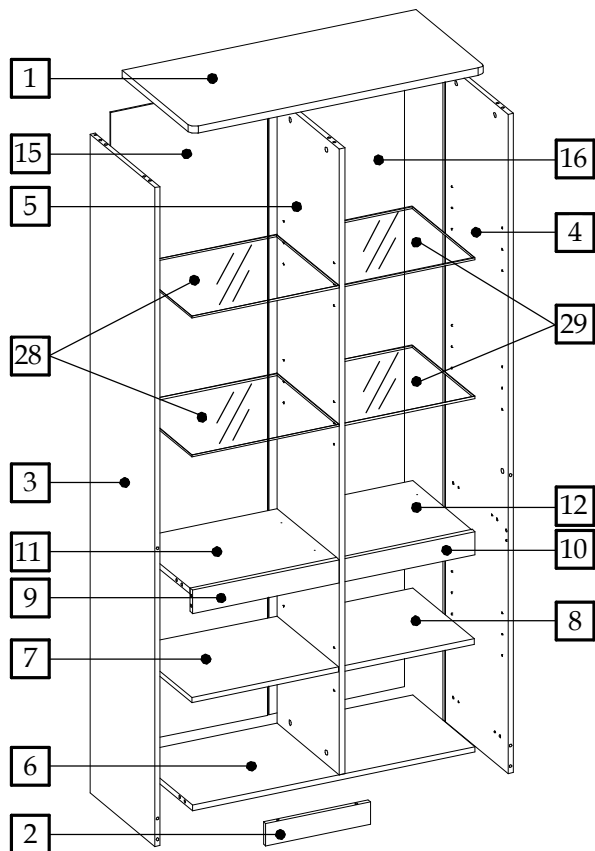

Element symbol	Measurements				Code	Paket
1	900	422	22	1	1002/2002	2/3
2	400	84	22	1	1008	1/3
3	1978	396	16	1	1003	1/3
4	1978	396	16	1	1004	1/3
5	1878	381	16	1	1001	1/3
6	864	382	16	1	1005/2005	2/3
7	450	382	16	1	N/A	1/3
8	399	382	16	1	N/A	2/3
9	449.5	70	16	1	1010	1/3
10	398.5	70	16	1	1015	2/3
11	449.5	364	16	1	1011	1/3
12	398.5	364	16	1	1016	2/3
13	529	400	16	1	1018	1/3
14	529	350	16	1	1019	1/3
15	1900	464	16	1	1032_v	1/3
16	1900	413	16	1	N/A	1/3
17	402	112	19	1	1001/3001	2/3
18	402	112	19	1	1006/3002	2/3
19	352	112	19	1	1009/3003	2/3
20	352	112	19	1	1010/3004	2/3
21	401	111	19	1	1002_v	2/3
22	351	111	19	1	1003_v	2/3
23	899	103	19	1	1004/3007	2/3
24	1878	72	19	1	1005/3008	1/3
25	1878	72	19	1	1005/3009	1/3
26	1068	392	4	1	Glass	3/3
27	1068	342	4	1	Glass	3/3
28	448	370	6	2	Glass	3/3
29	397	370	6	2	Glass	3/3

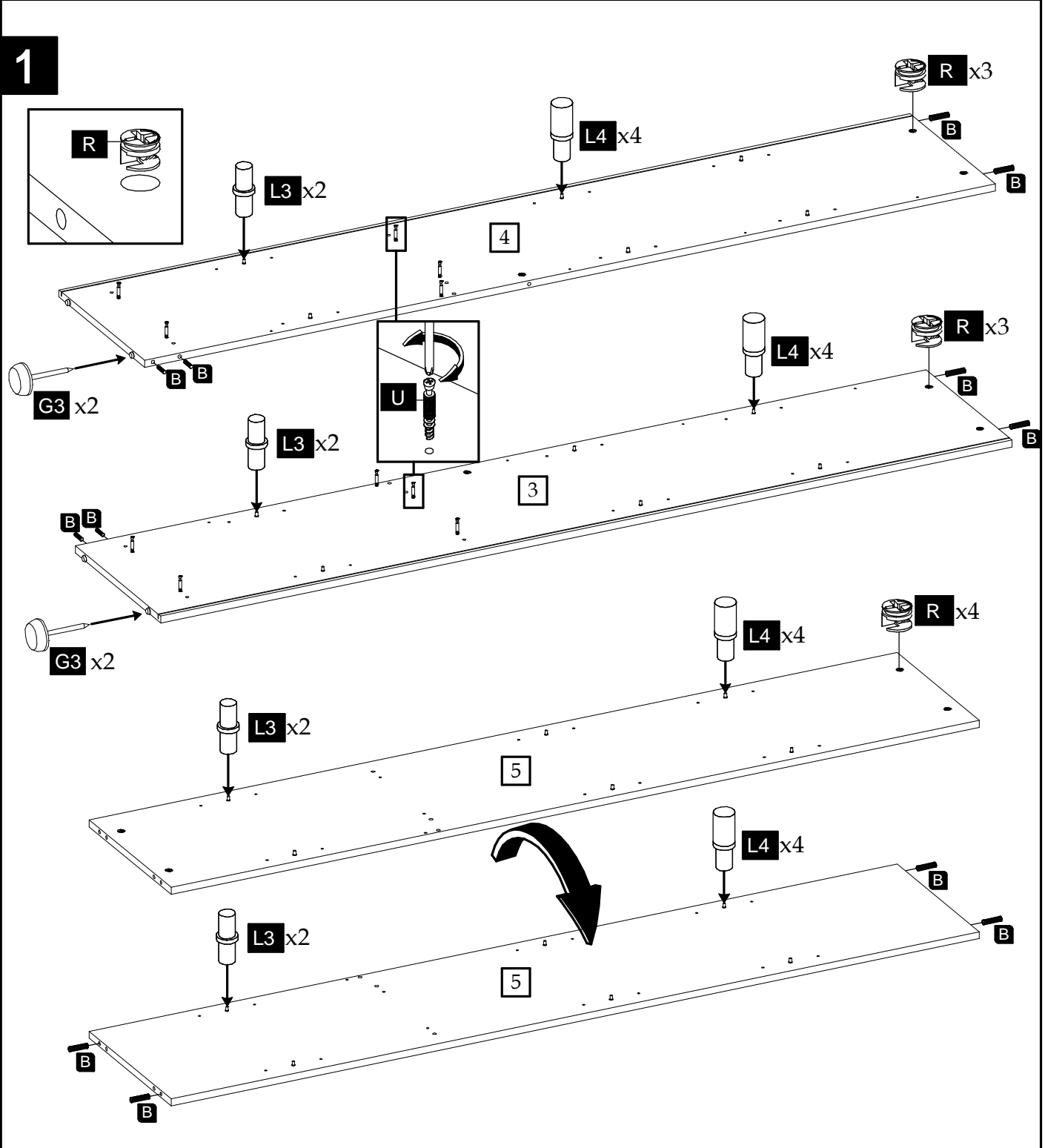

2

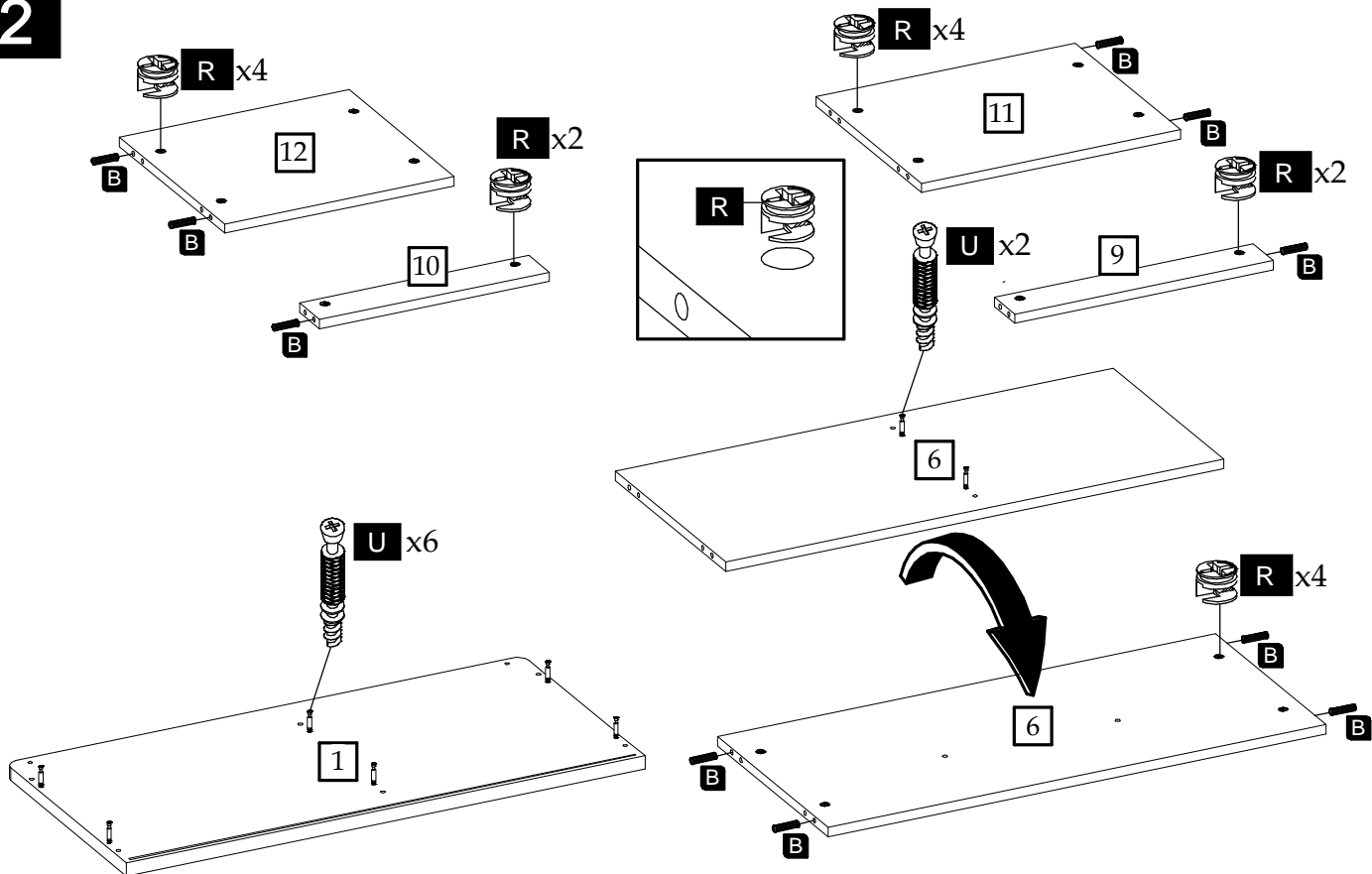

3

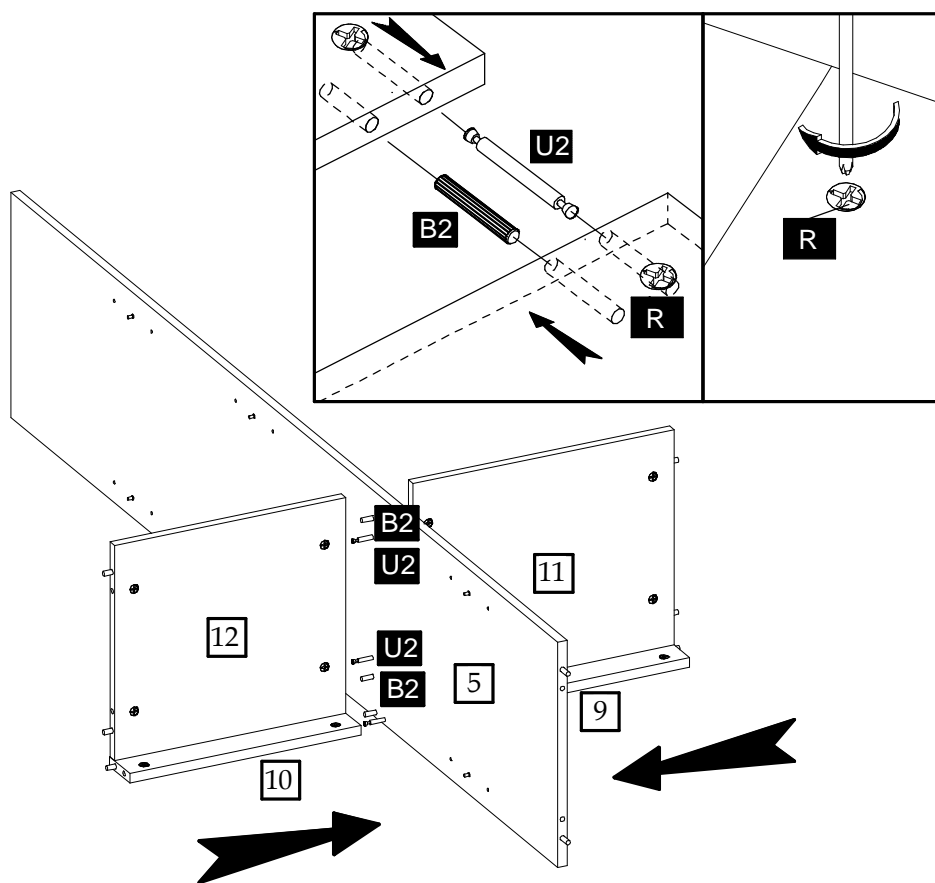

4

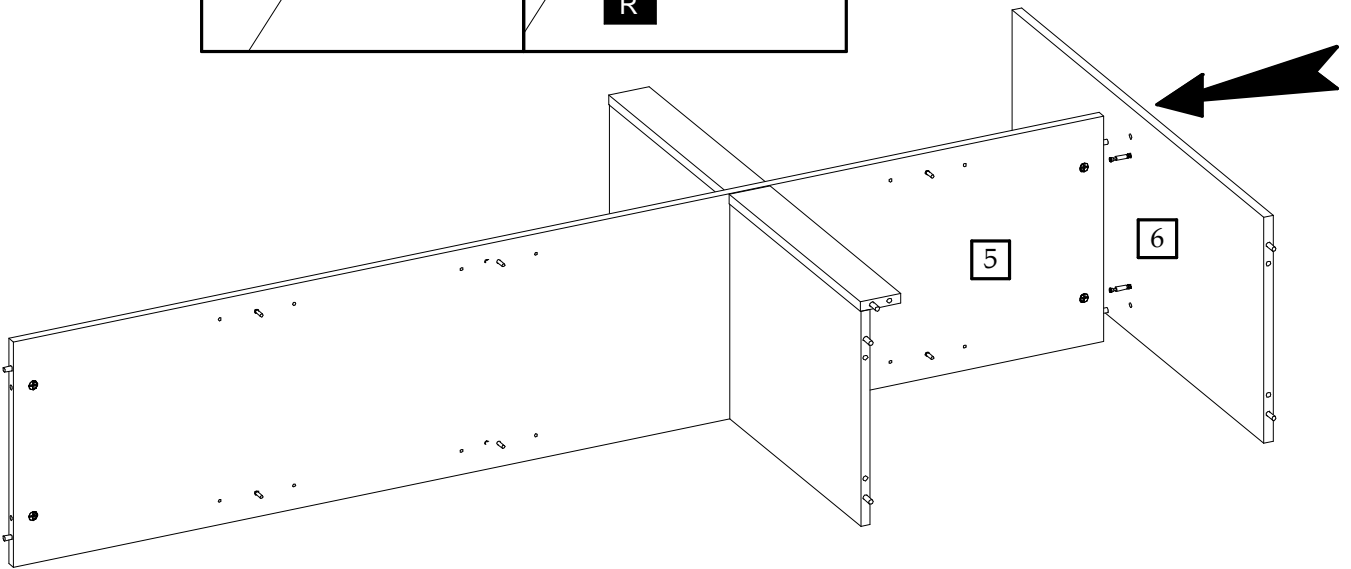
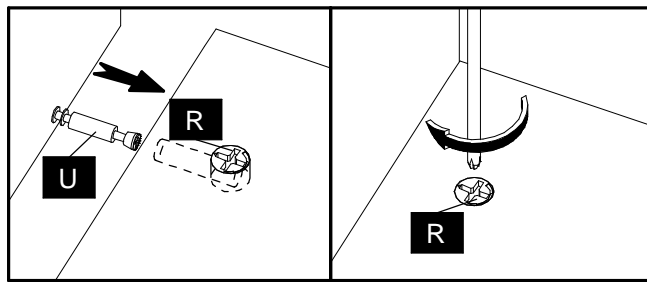

5

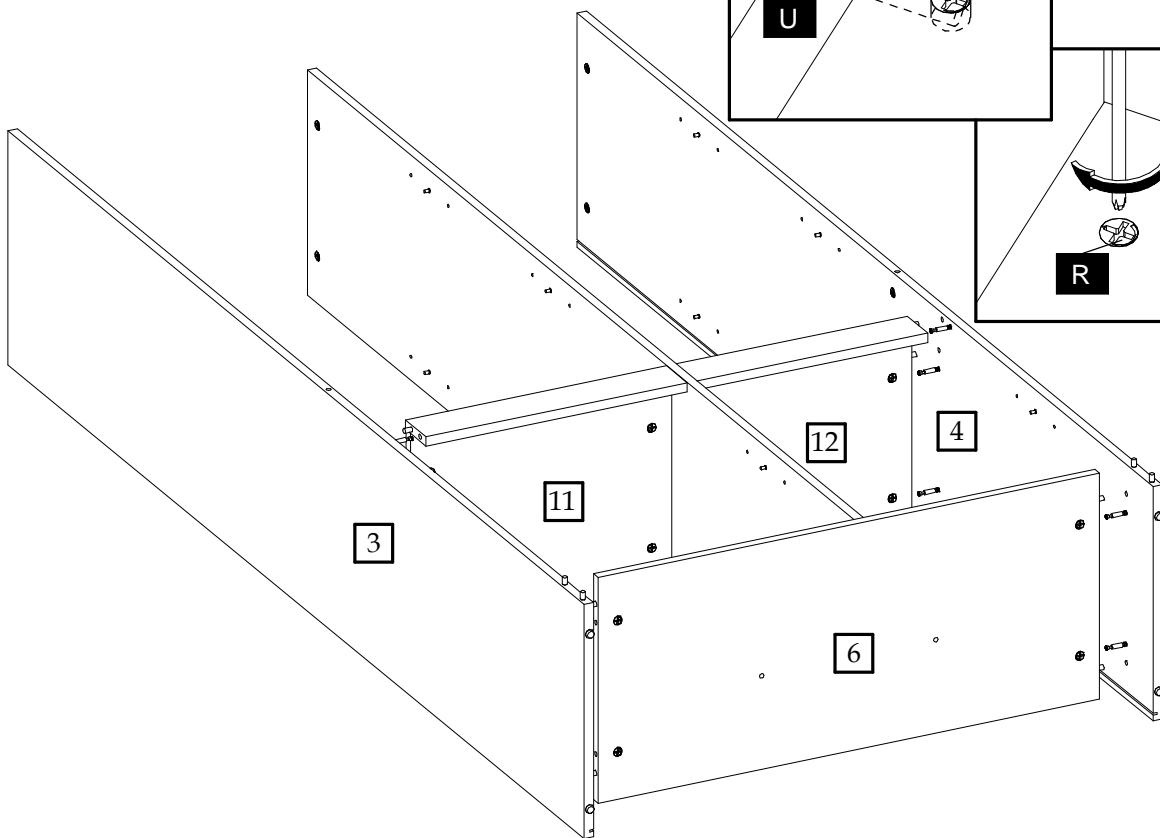
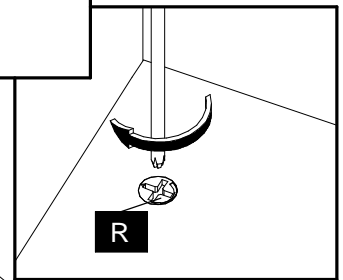
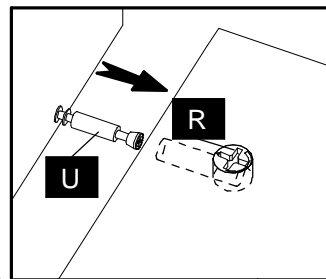

6

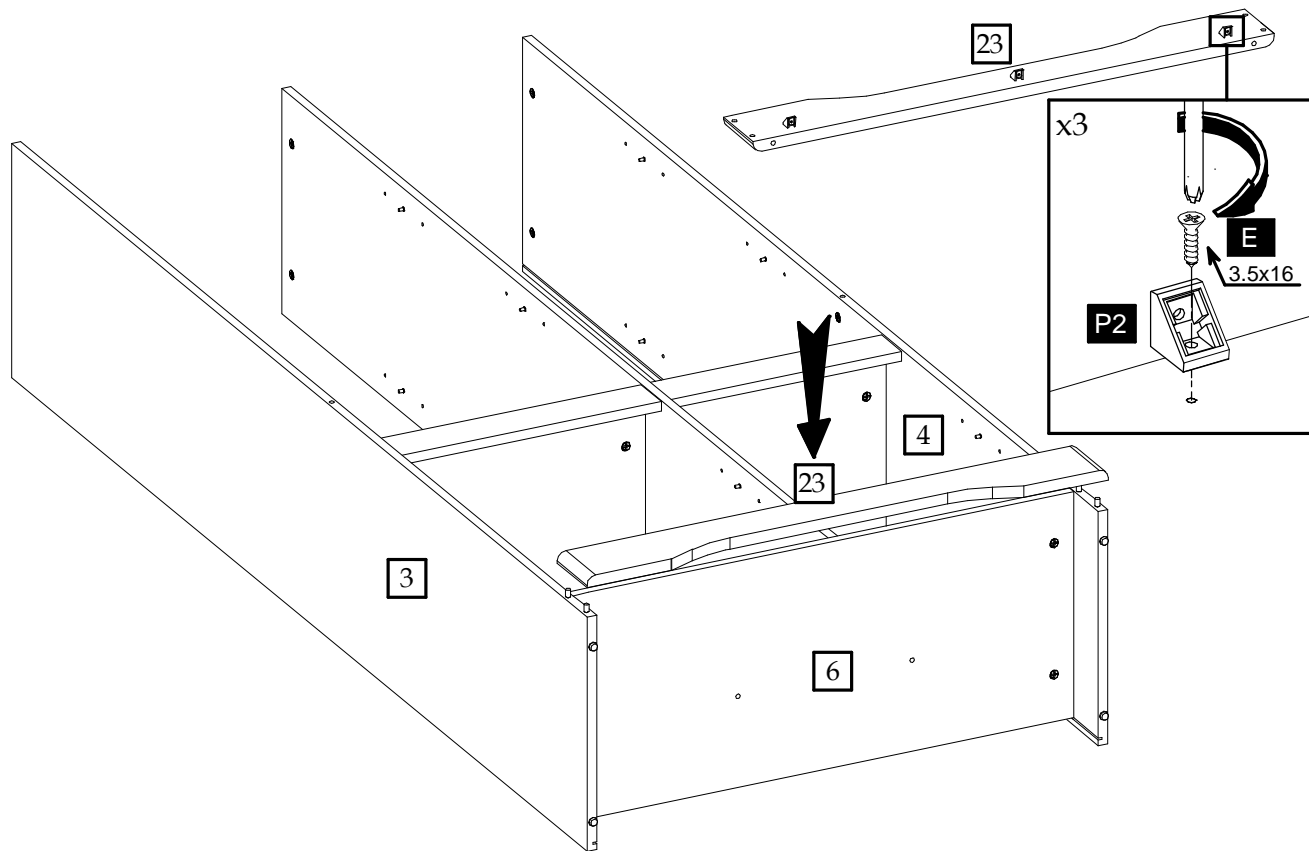

7

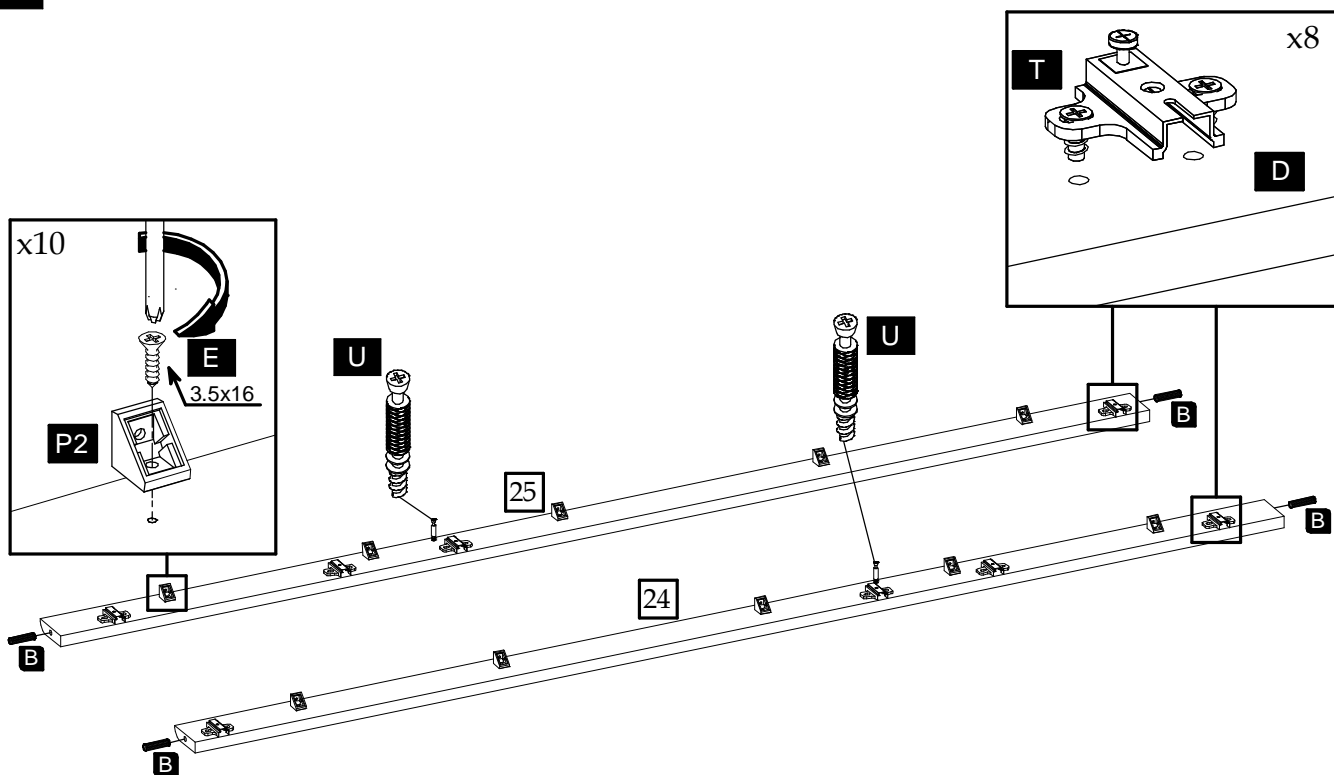

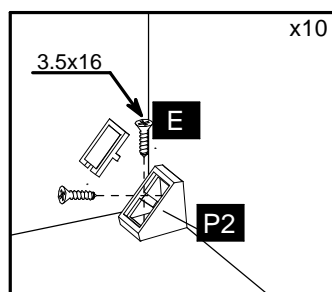
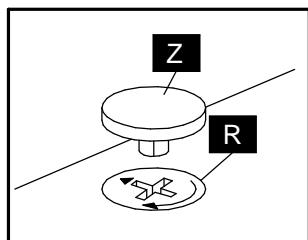
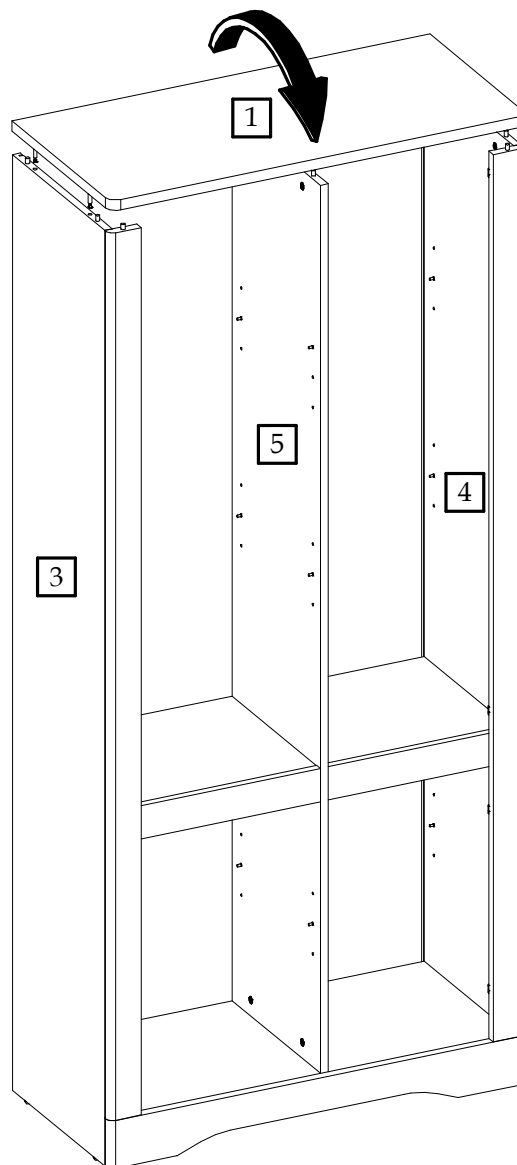
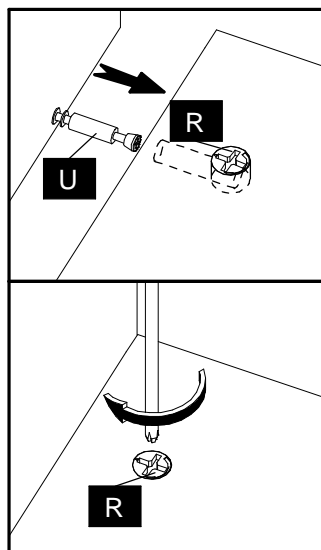
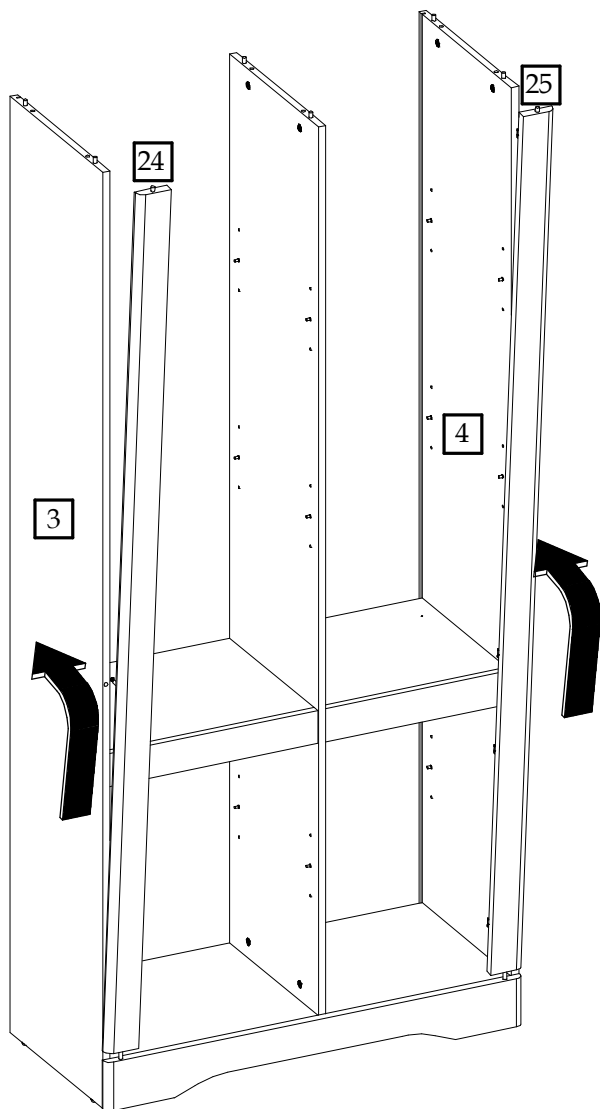

9

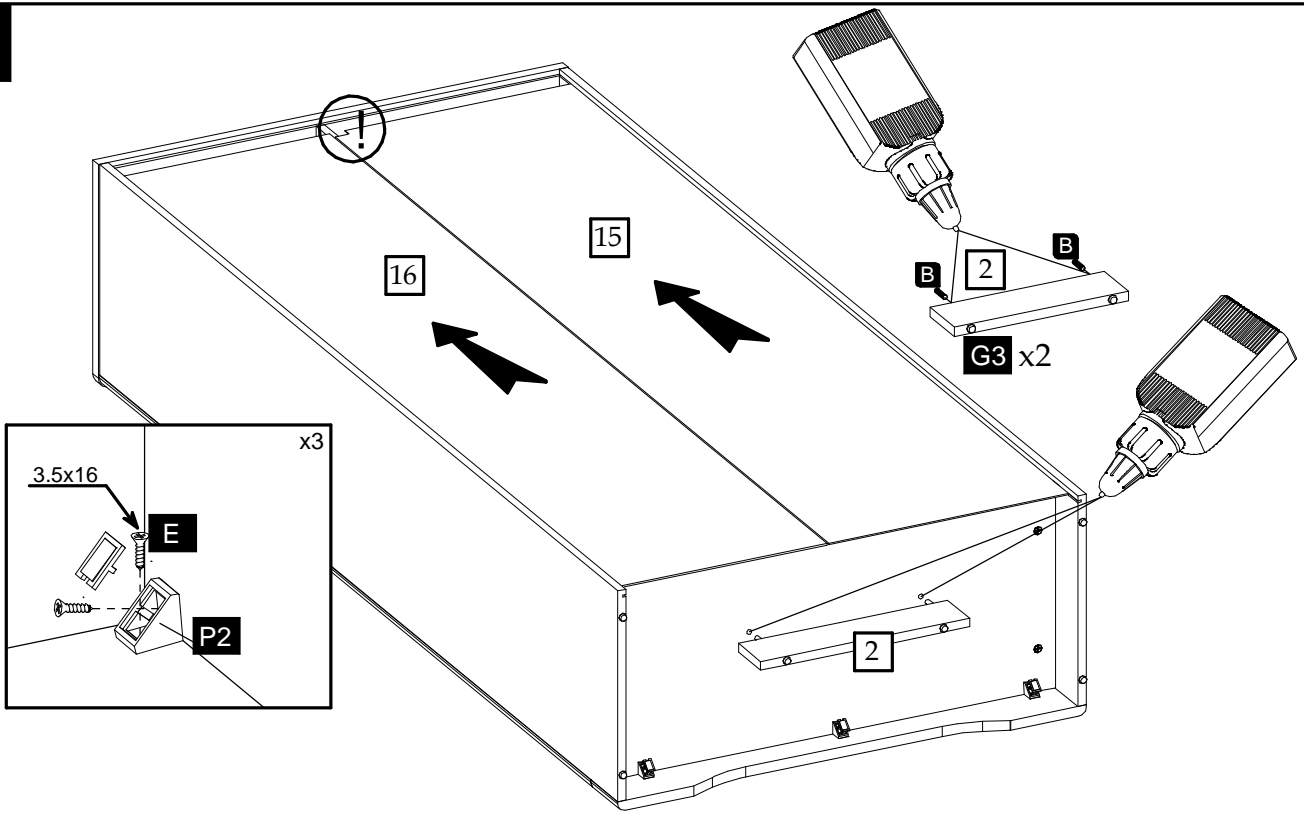

10

