

FIDEL

Typ I

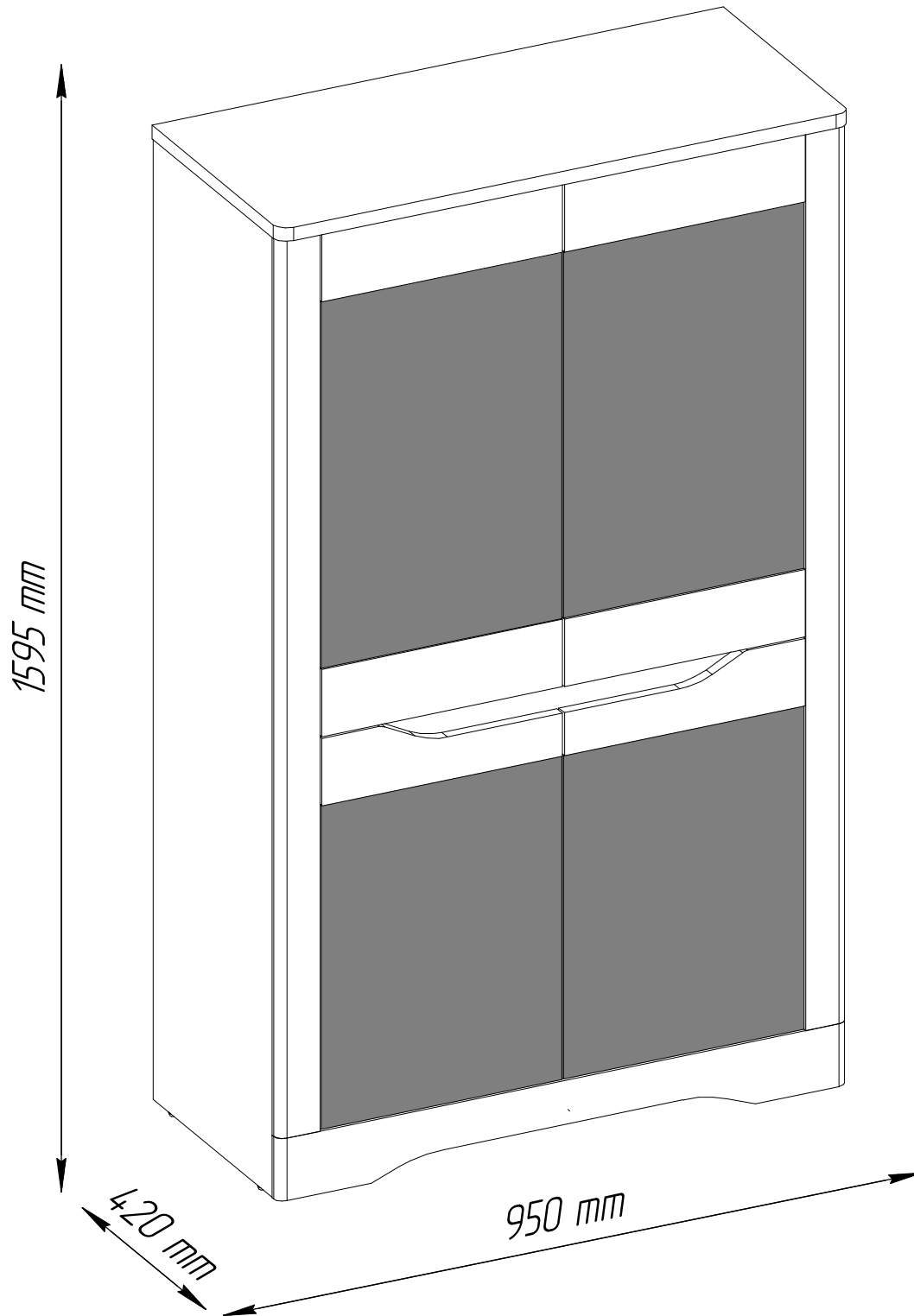

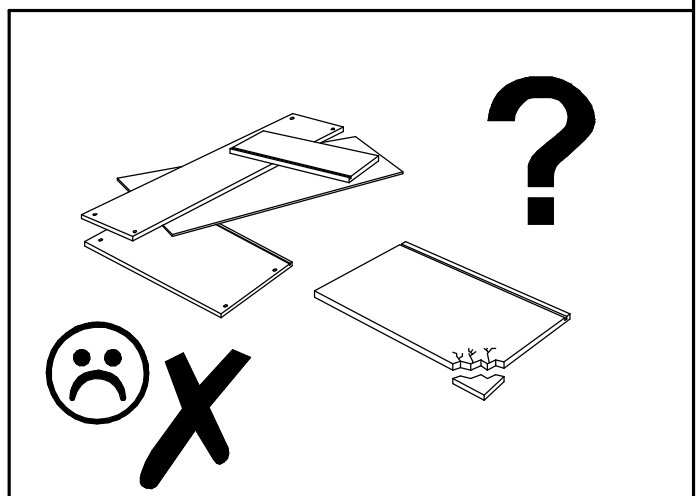

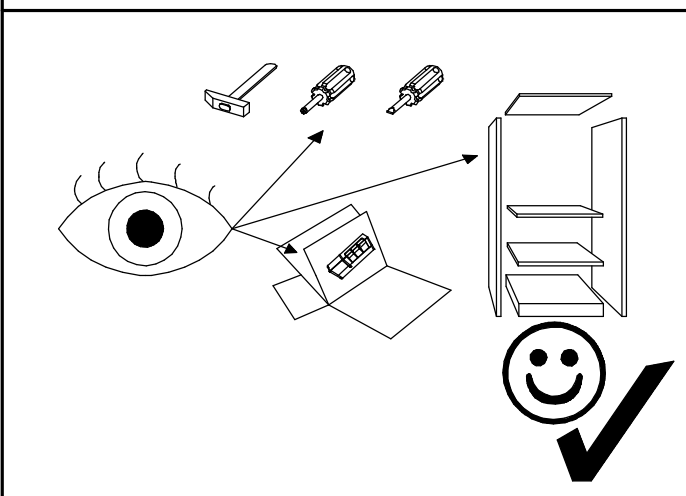
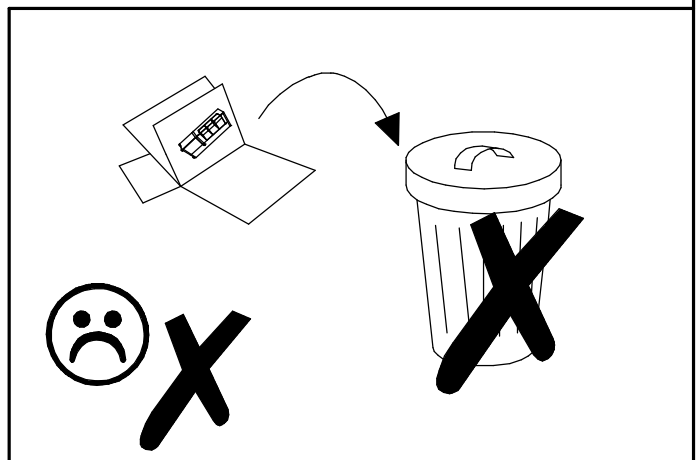
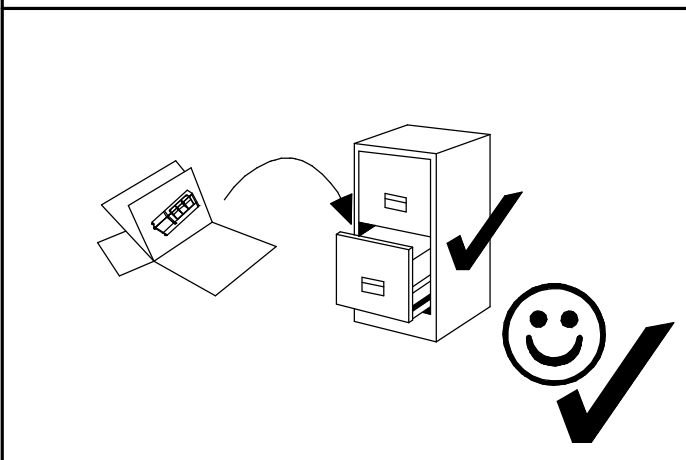
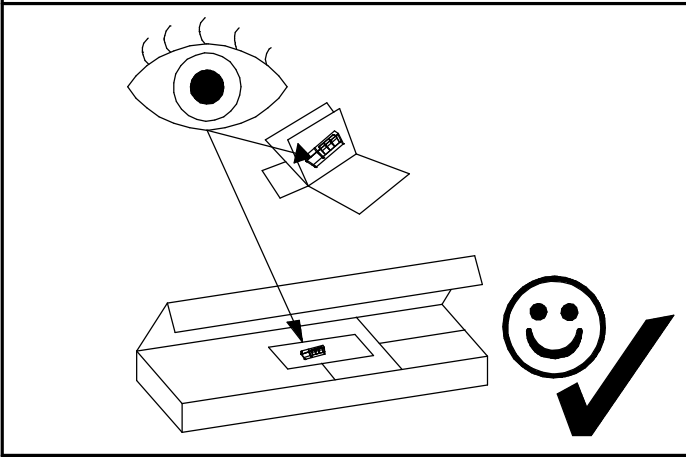
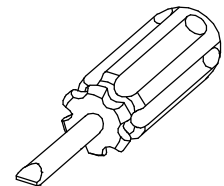
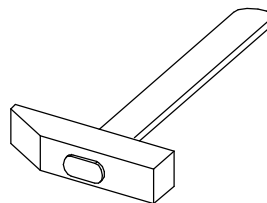
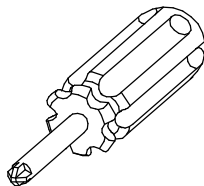
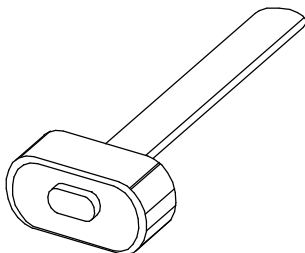
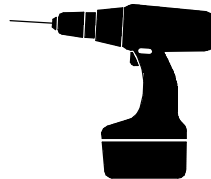
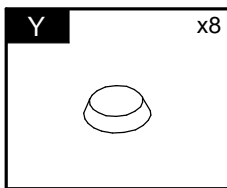
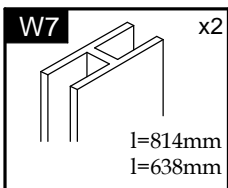
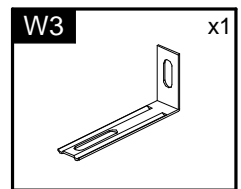
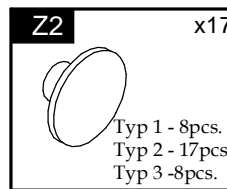
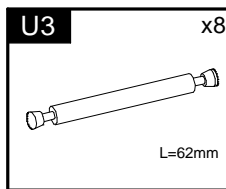
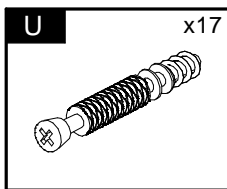
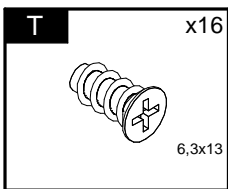
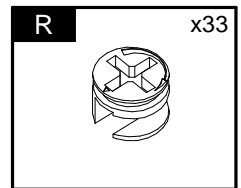
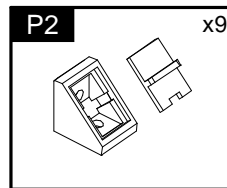
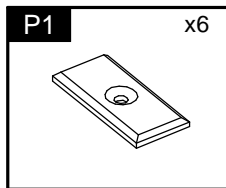
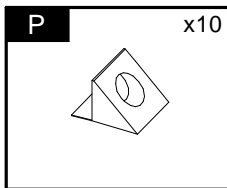
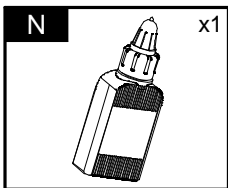
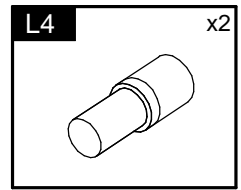
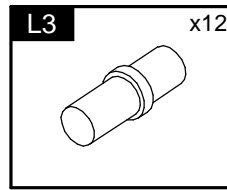
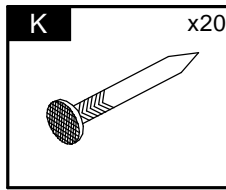
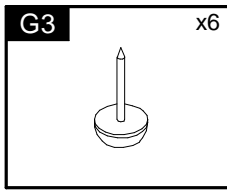
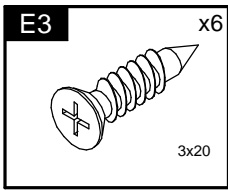
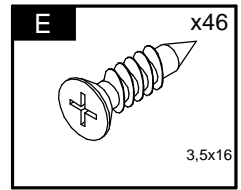
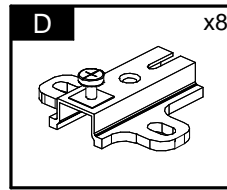
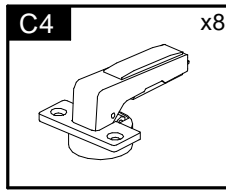
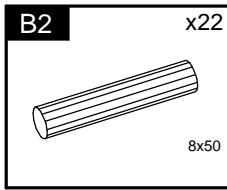
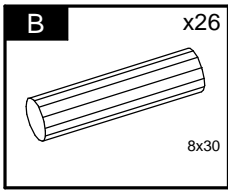
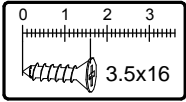
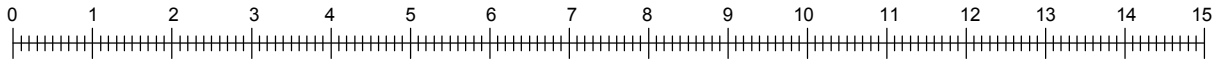

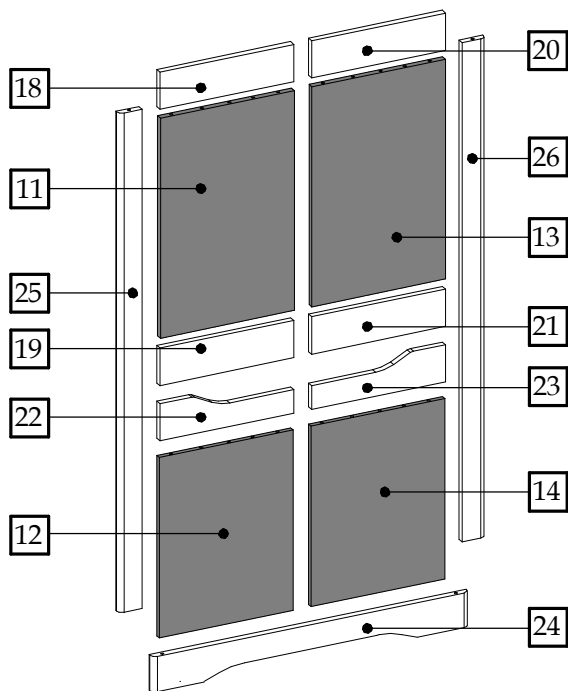
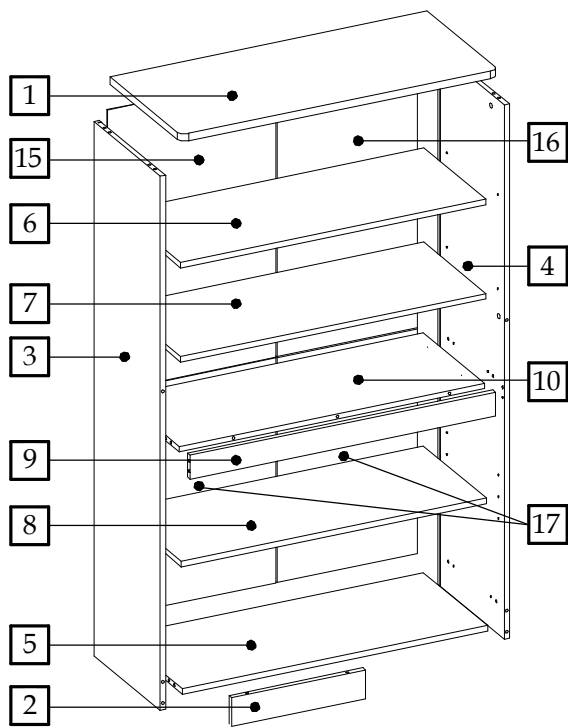

Element symbol	Measurements				Code	Paket
1	949	422	22	1	1002/2002	2/2
2	400	84	22	1	1008	2/2
3	1568	396	16	1	1028	1/2
4	1568	396	16	1	1004	1/2
5	913	382	16	1	1005	2/2
6	913	382	16	1	N/A	2/2
7	913	382	16	1	N/A	2/2
8	913	382	16	1	N/A	2/2
9	913	70	16	1	1025	2/2
10	913	364	16	1	1026	2/2
11	599	400	16	1	1017	1/2
12	529	400	16	1	1018	1/2
13	599	400	16	1	1019	1/2
14	529	400	16	1	1020	1/2
15	829	463	3	1	1031_v	1/2
16	829	463	3	1	N/A	1/2
17	661	463	3	2	N/A	1/2
18	402	112	19	1	1001/3001	2/2
19	402	112	19	1	1006/3002	2/2
20	402	112	19	1	1001/3003	2/2
21	402	112	19	1	1007/3004	2/2
22	401	111	19	1	1002_v	2/2
23	401	111	19	1	1011_v	2/2
24	948	103	19	1	1012/3007	2/2
25	1468	72	19	1	1015/3008	1/2
26	1468	72	19	1	1015/3009	1/2

2

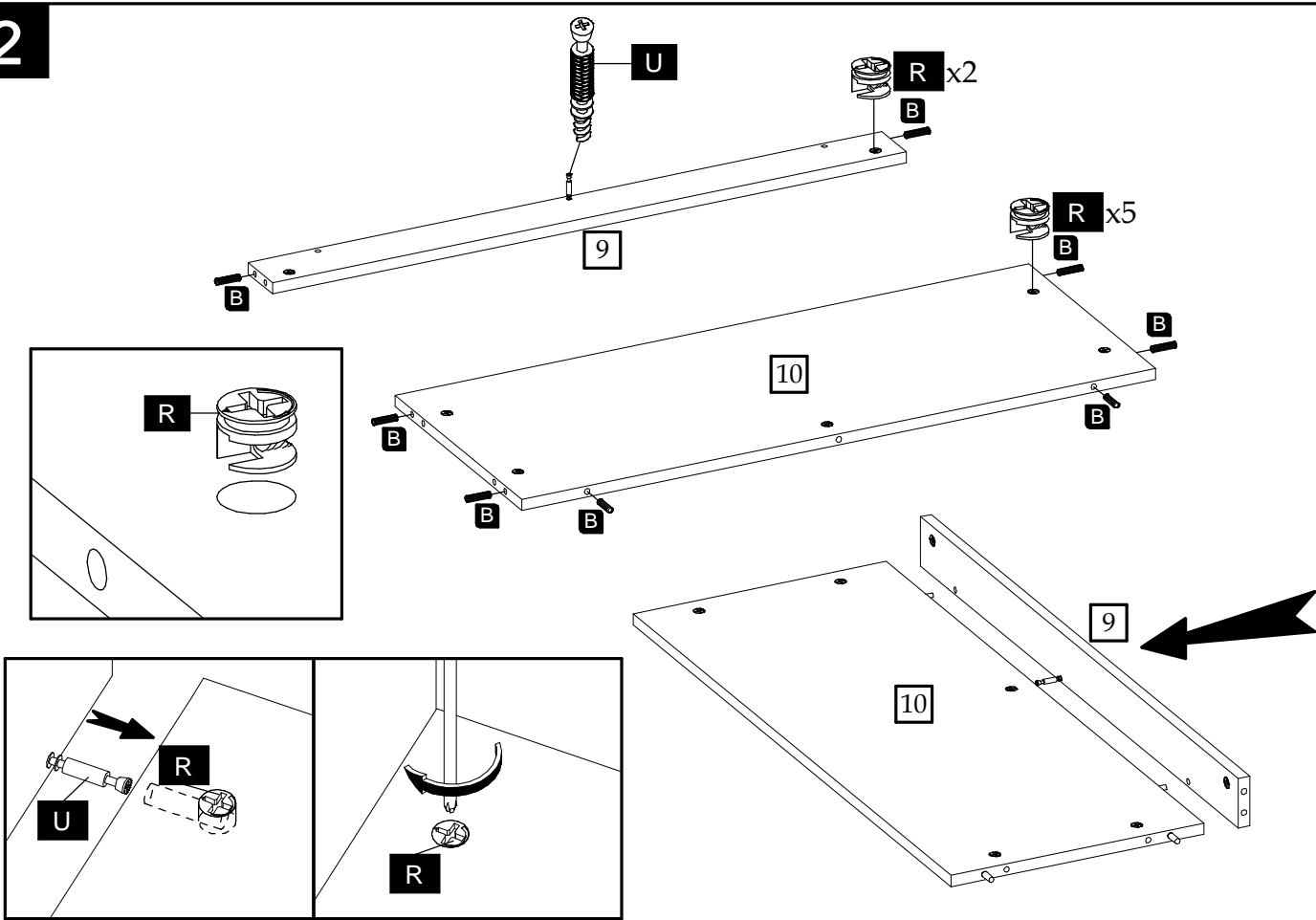

3

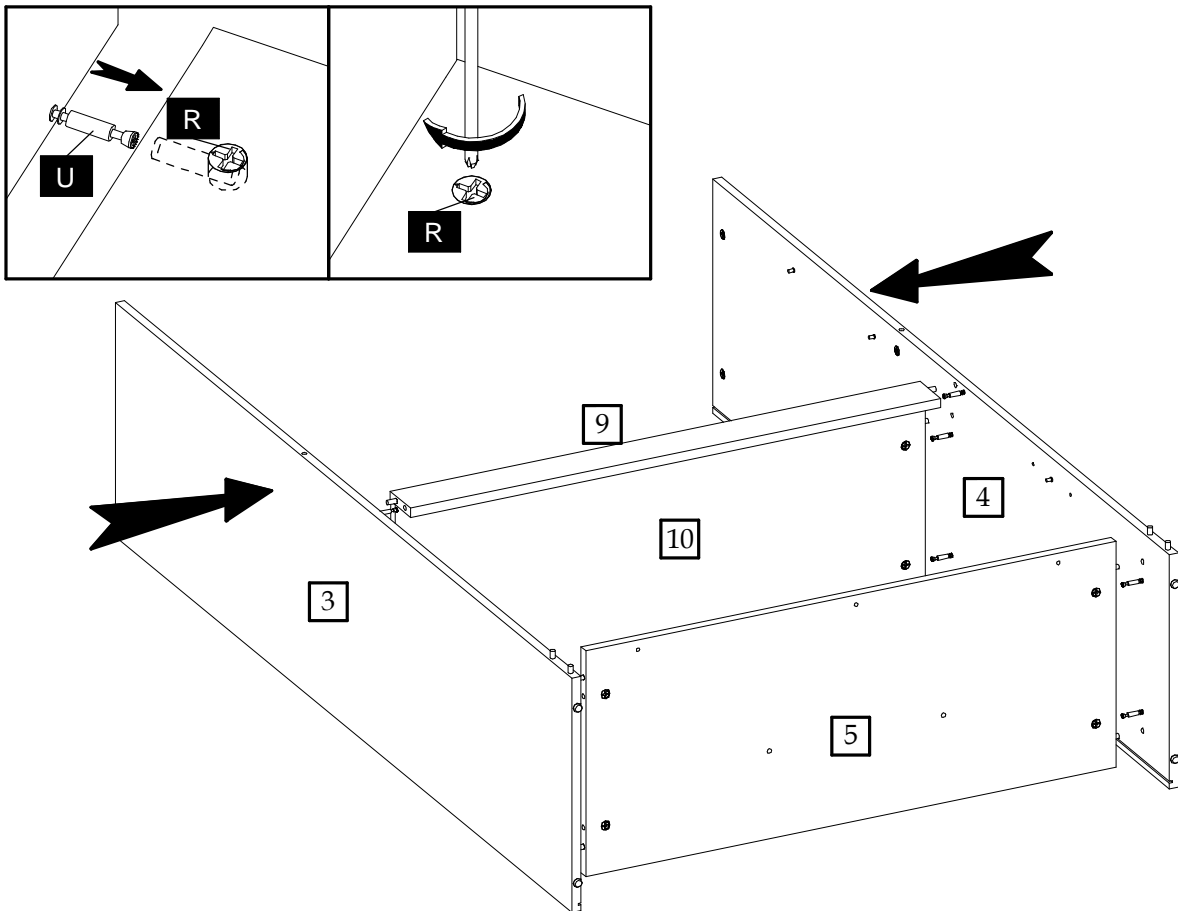

4

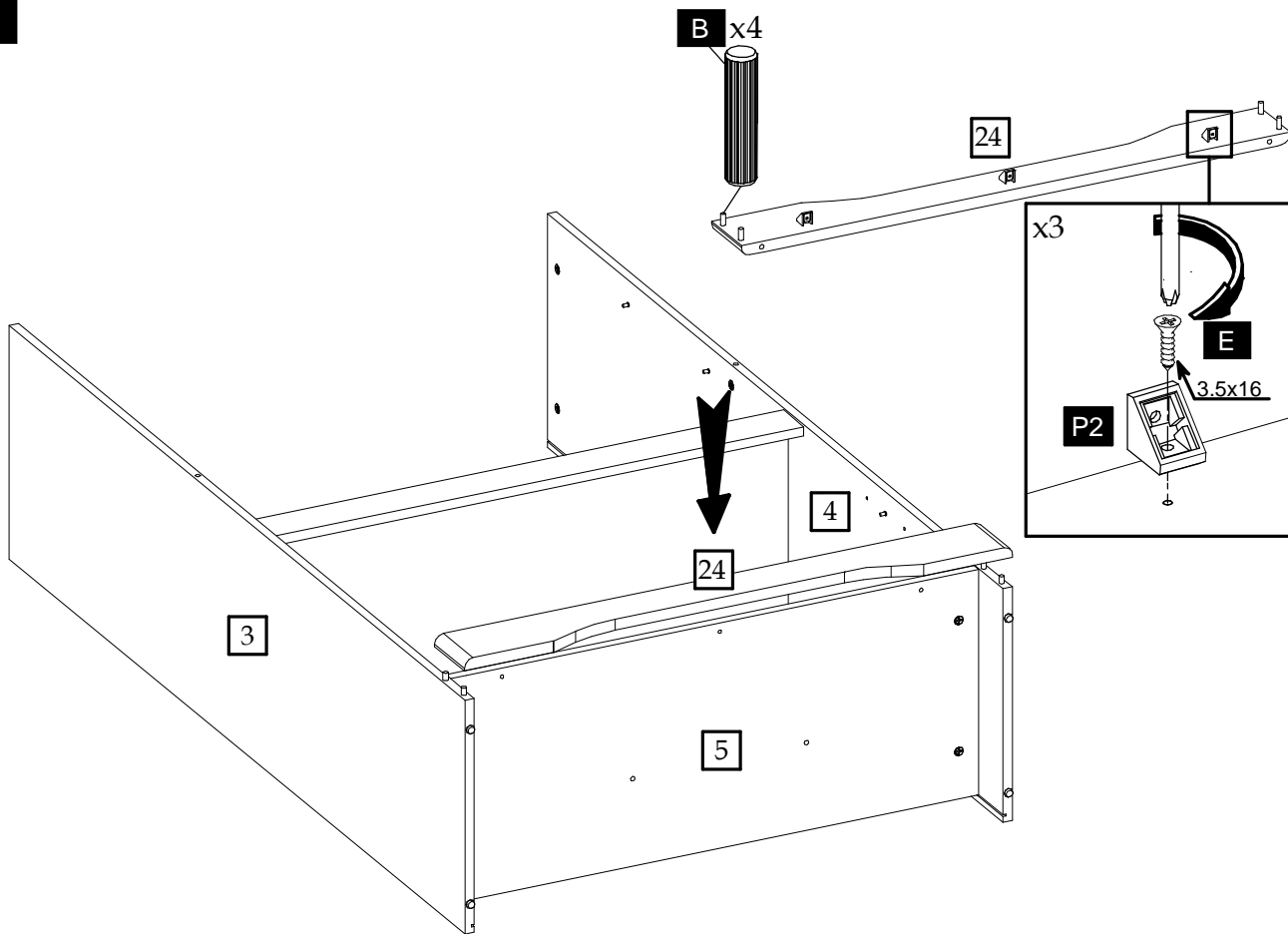

5

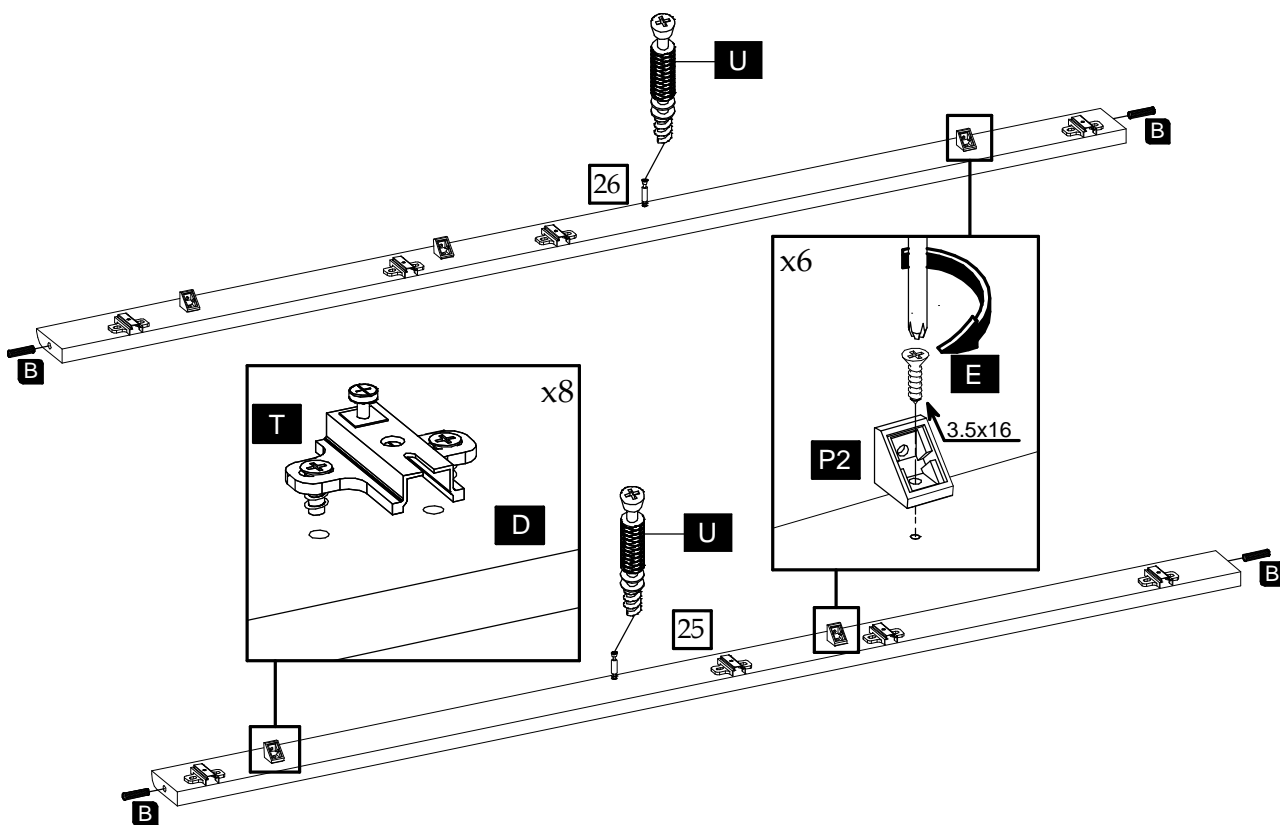

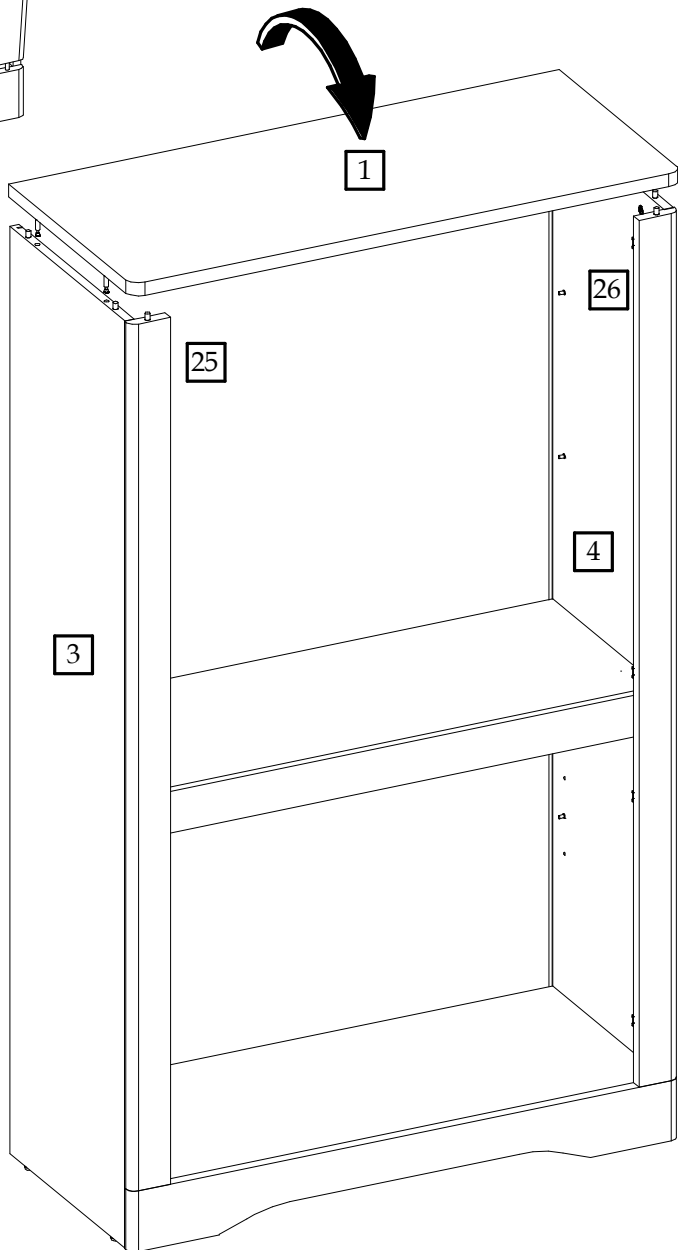
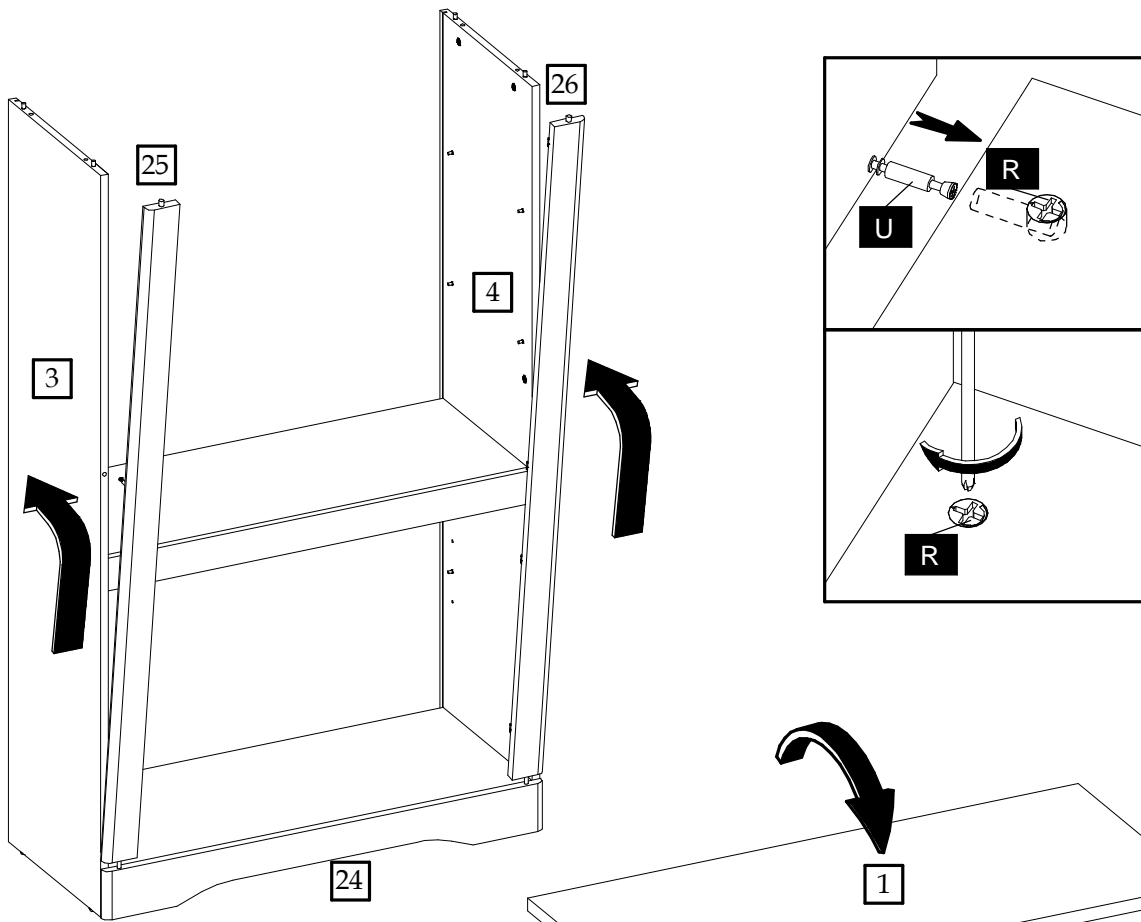

7

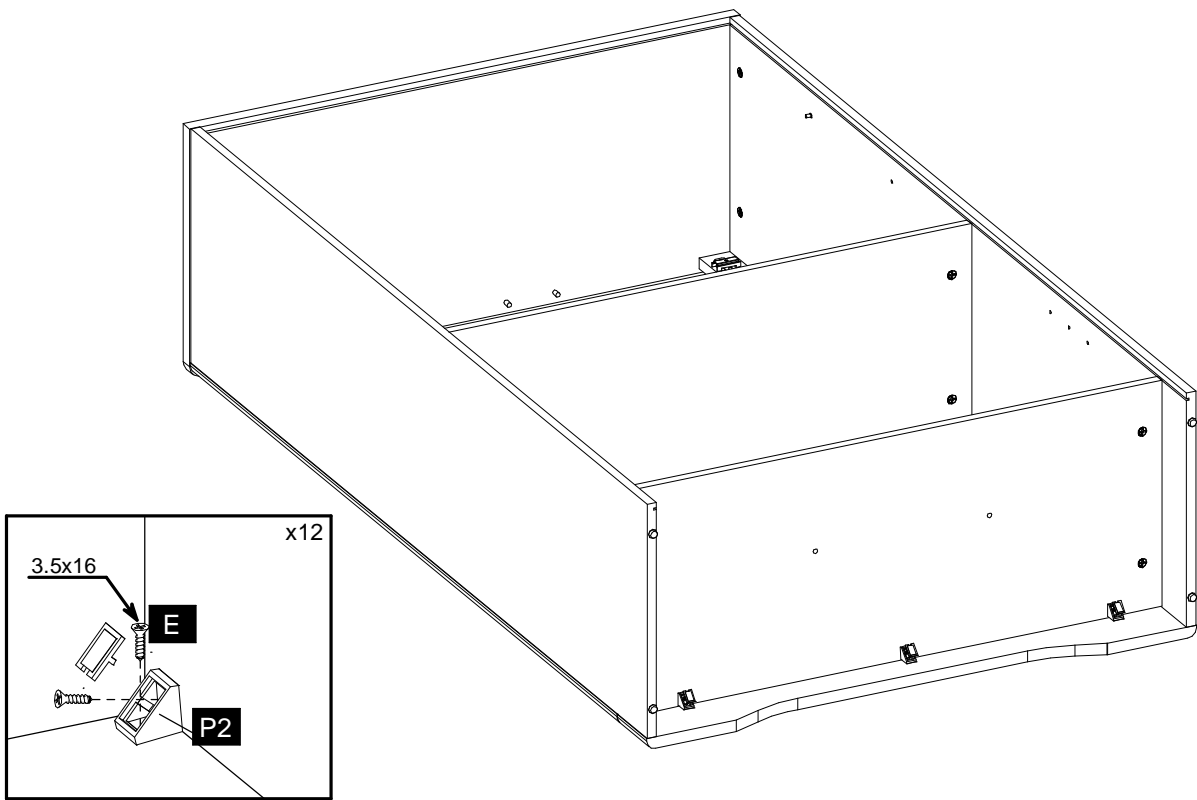

8

