

FIDEL

Typ X2

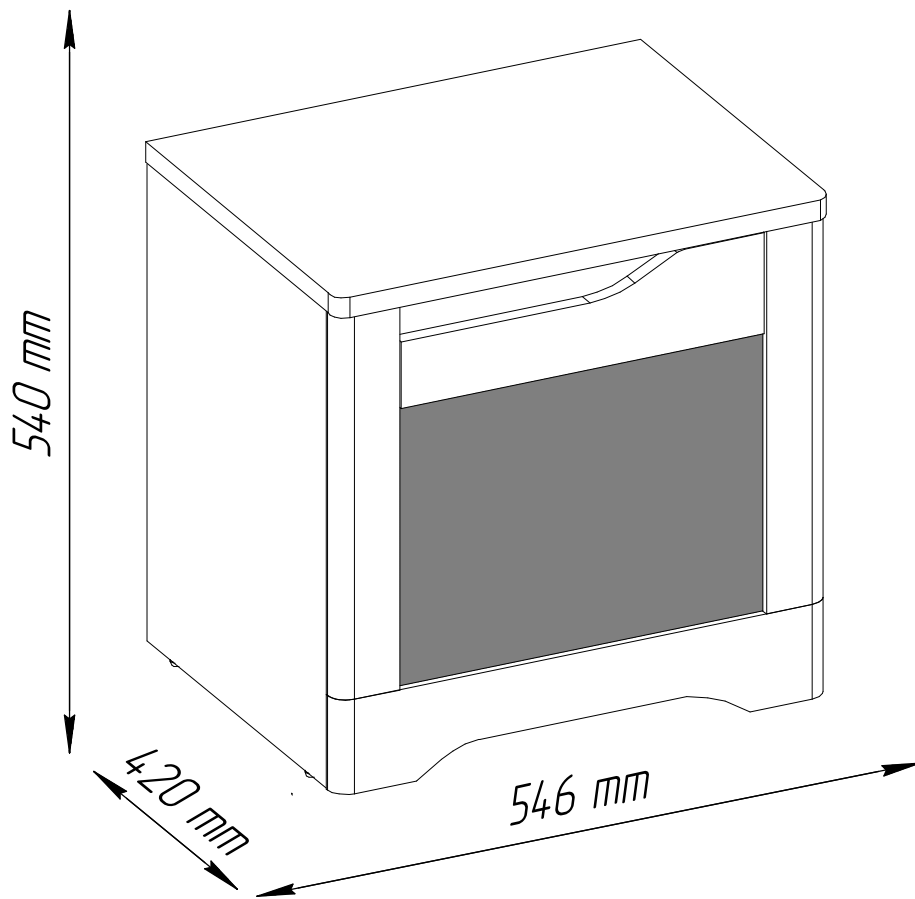

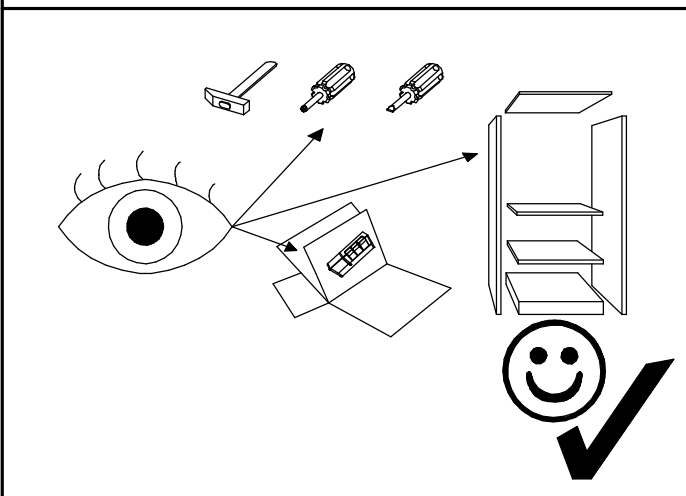

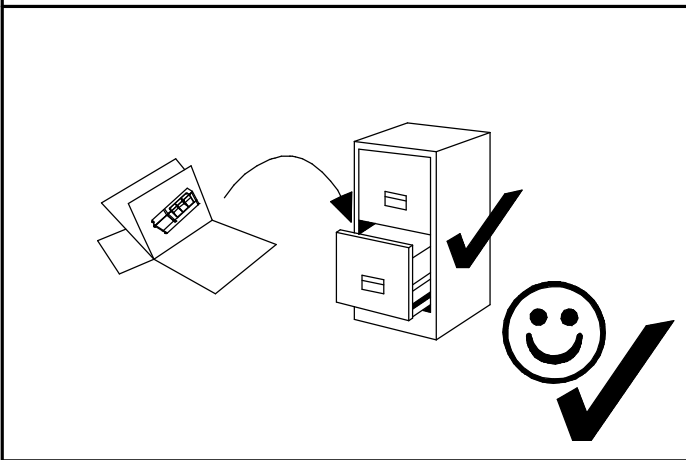
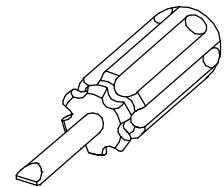
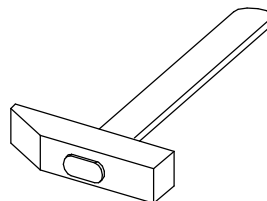
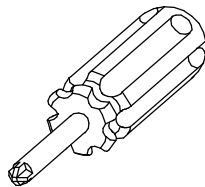
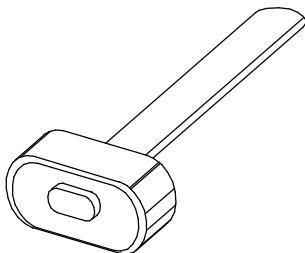
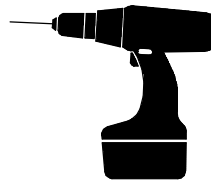
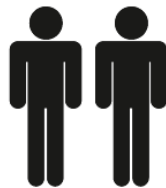
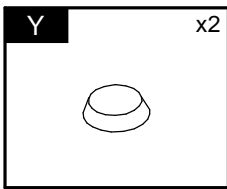
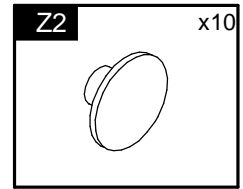
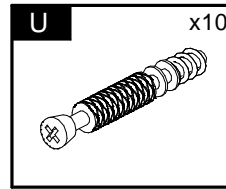
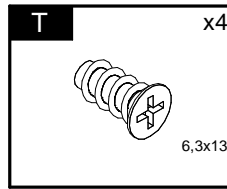
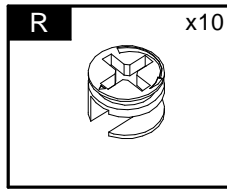
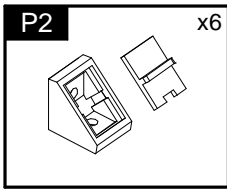
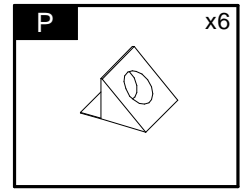
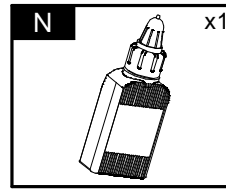
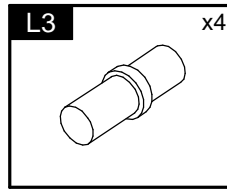
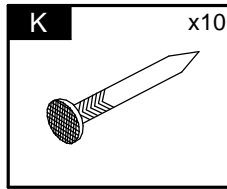
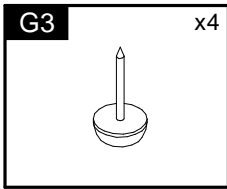
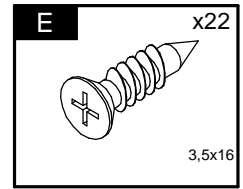
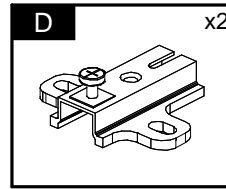
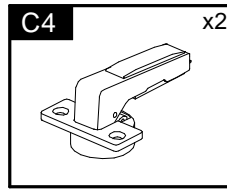
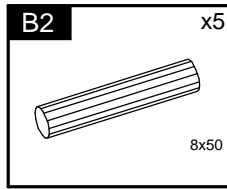
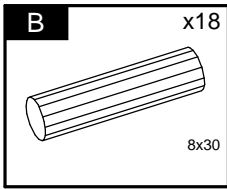
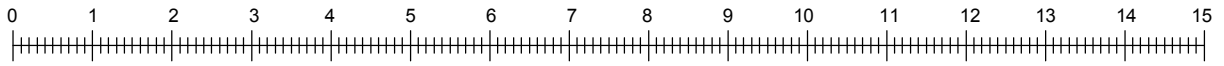

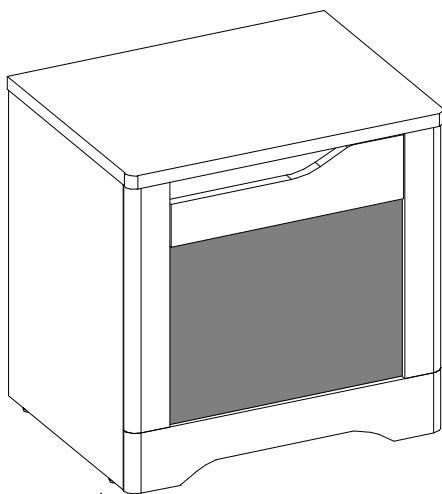

Element symbol	Measurements				Code	Paket
1	547	422	22	1	1002/2002	1/1
2	518	396	16	1	1003	1/1
3	518	396	16	1	1004	1/1
4	510	382.5	16	1	1005	1/1
5	510	360	16	1	N/A	1/1
6	510	70	16	1	1025	1/1
7	301	400	16	1	1023	1/1
8	524	440	3	1	N/A	1/1
9	401	111	19	1	1011_v	1/1
10	545	103	19	1	1008/3004	1/1
11	418	72	19	1	1018/3005	1/1
12	418	72	19	1	1018/3006	1/1

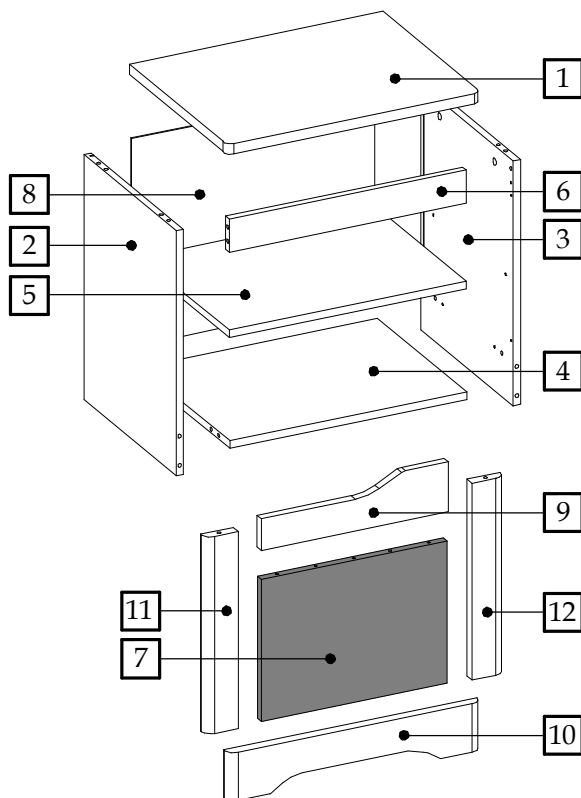

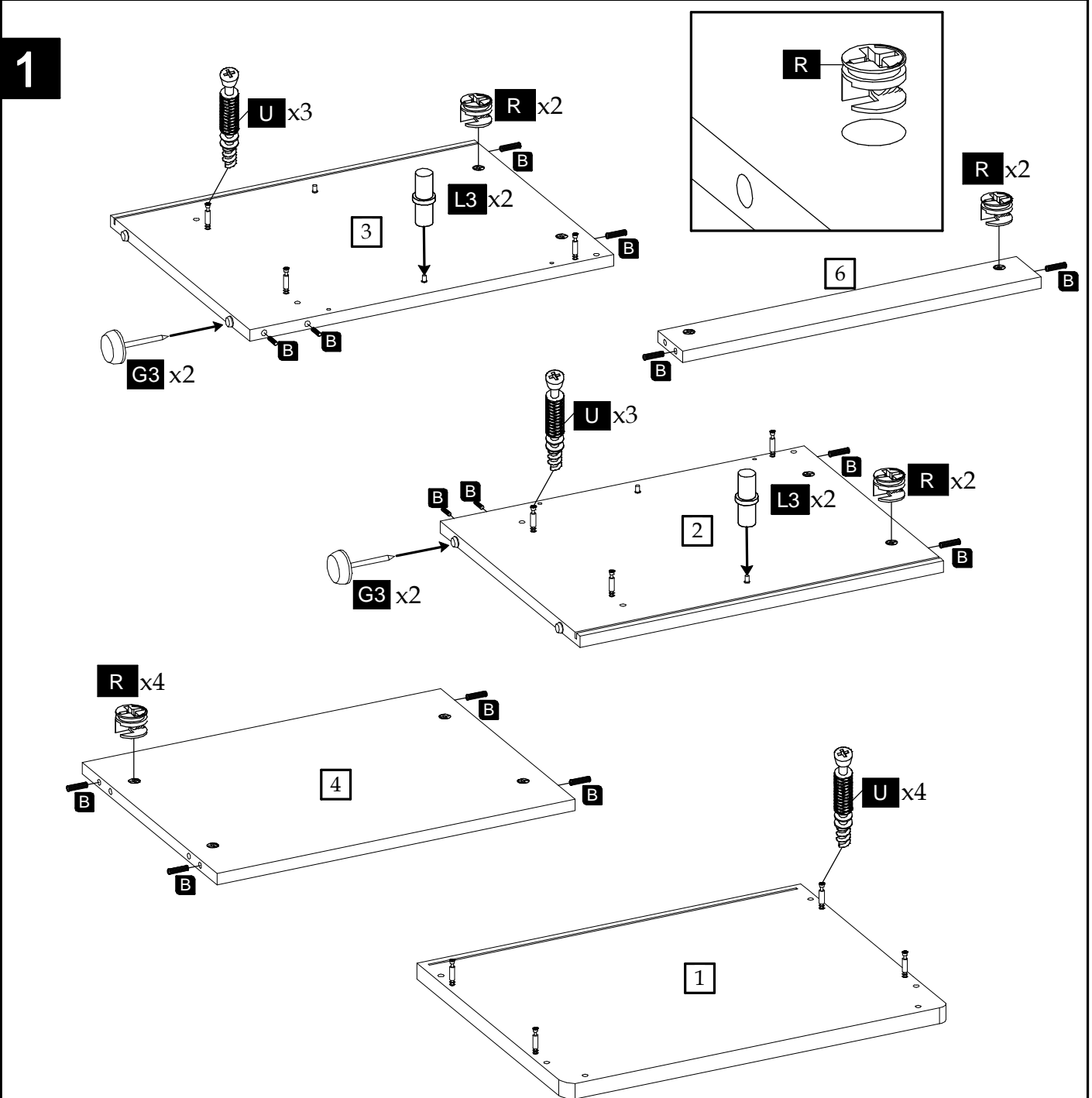

2

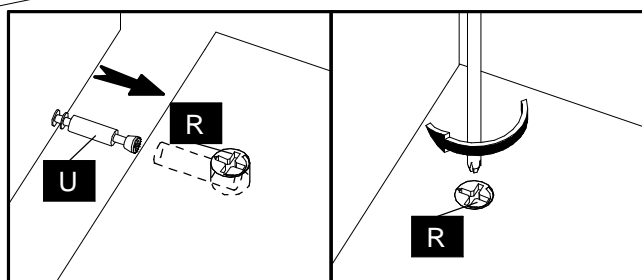
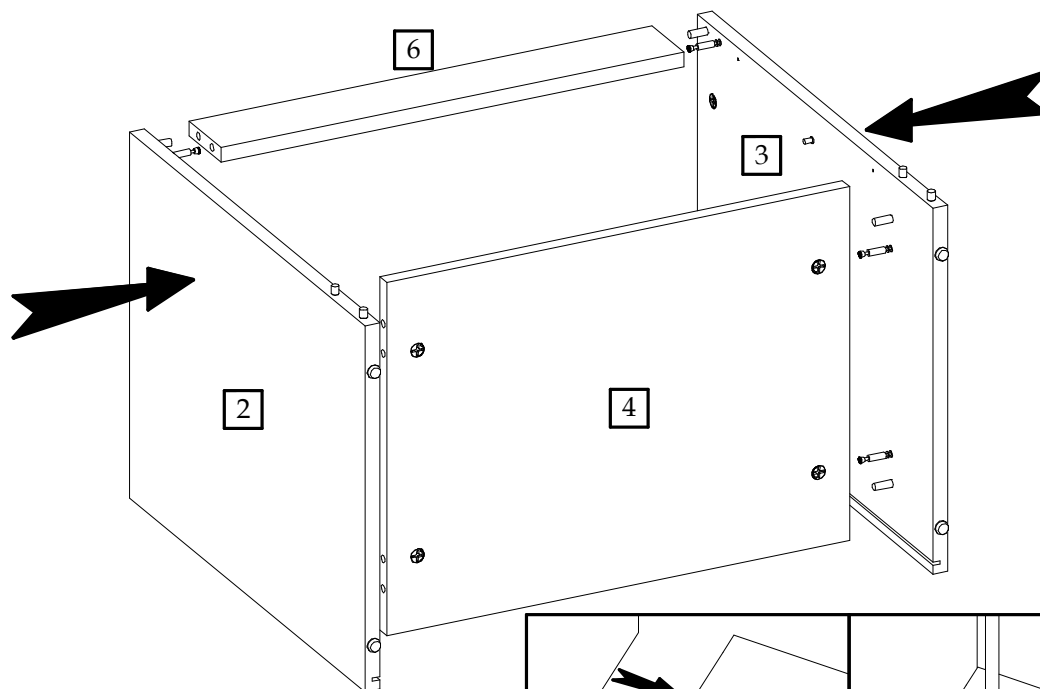

3

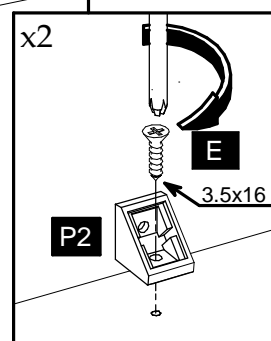
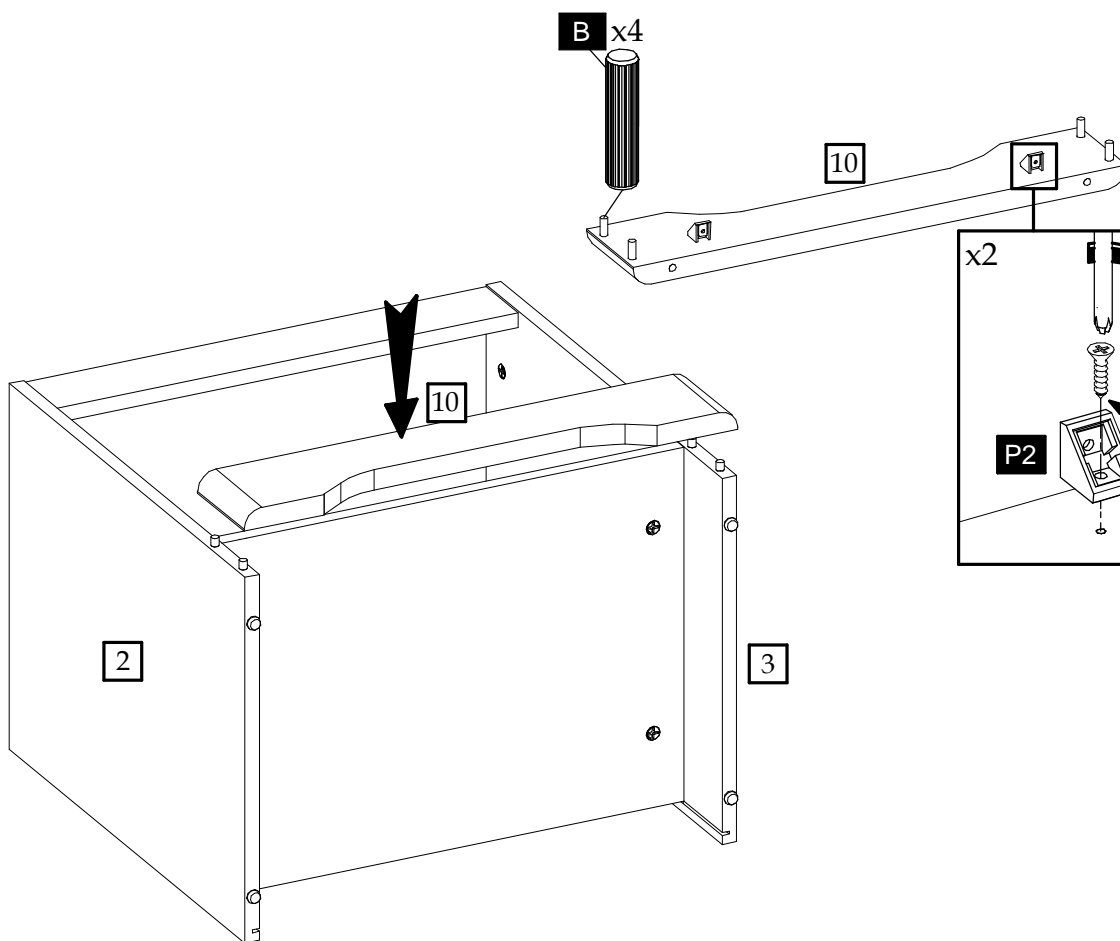

4

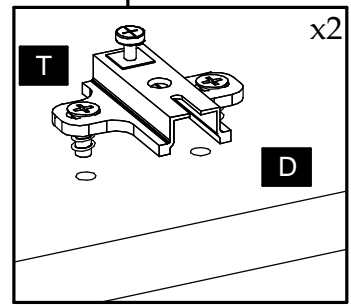
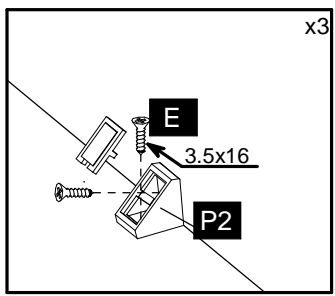
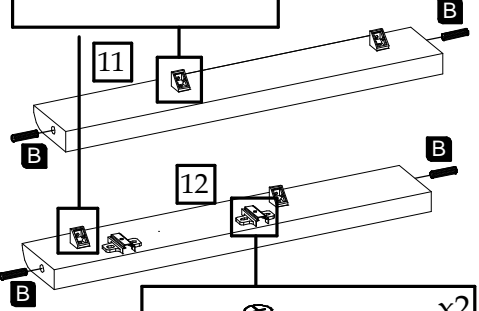
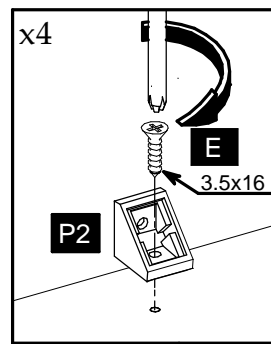
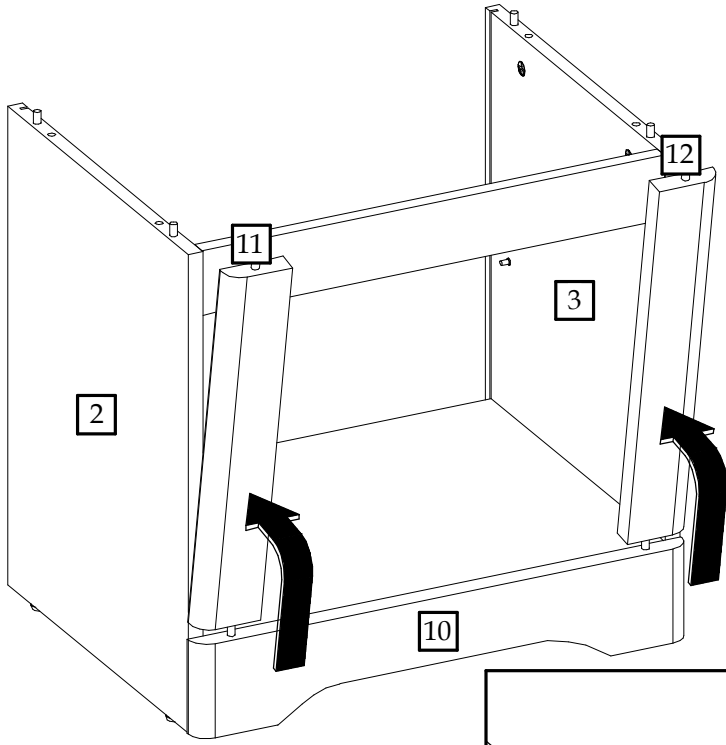

5

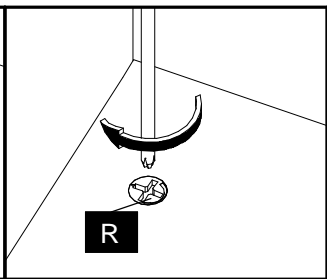
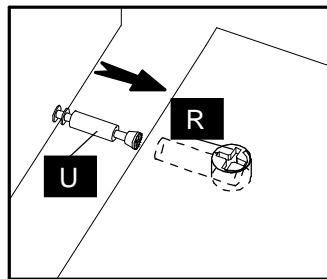
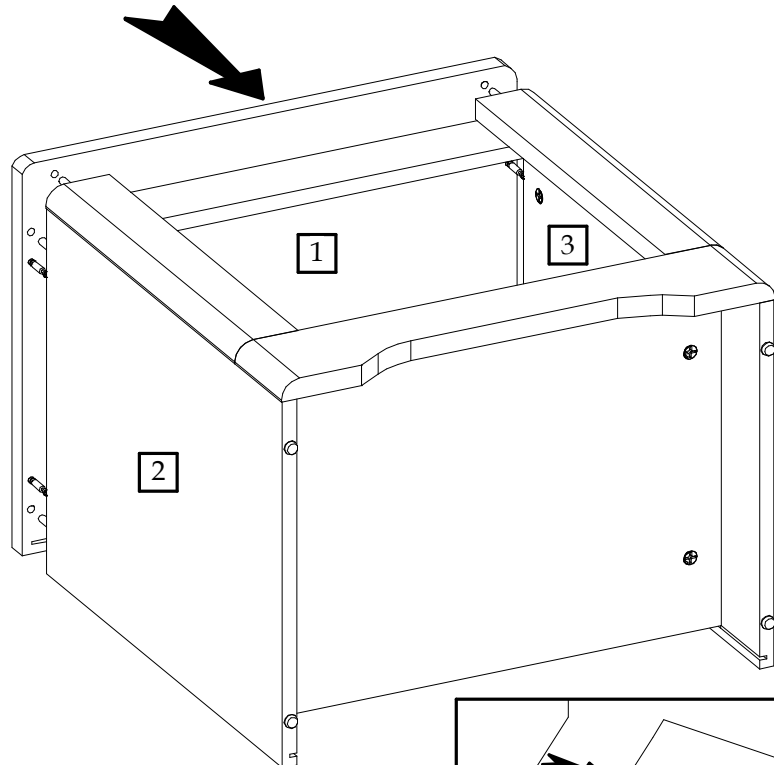

6

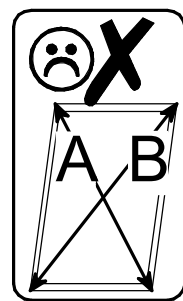
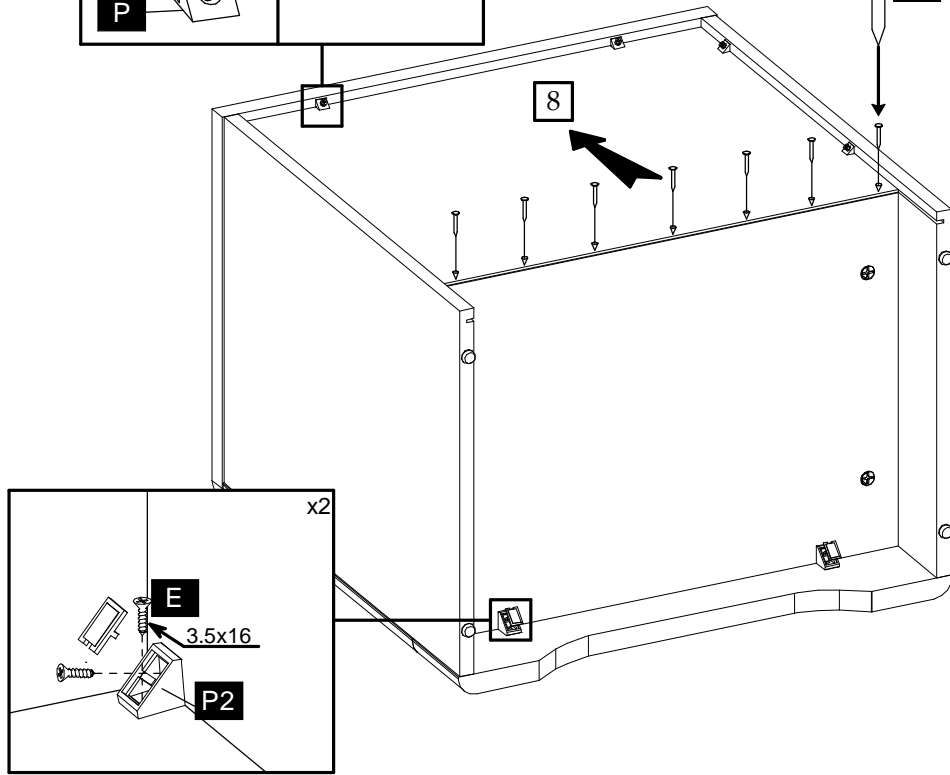
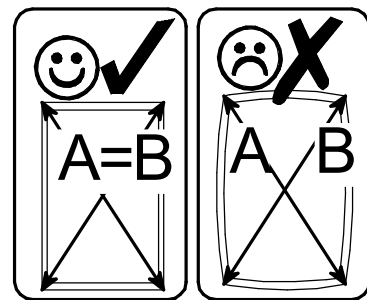
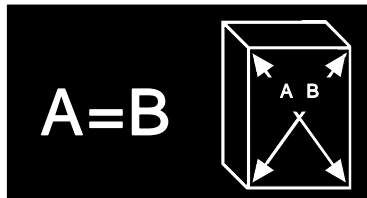
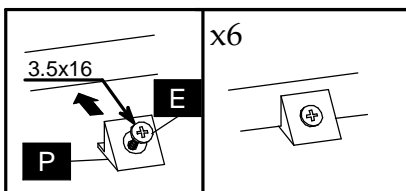

7

