

Helen

Typ A2

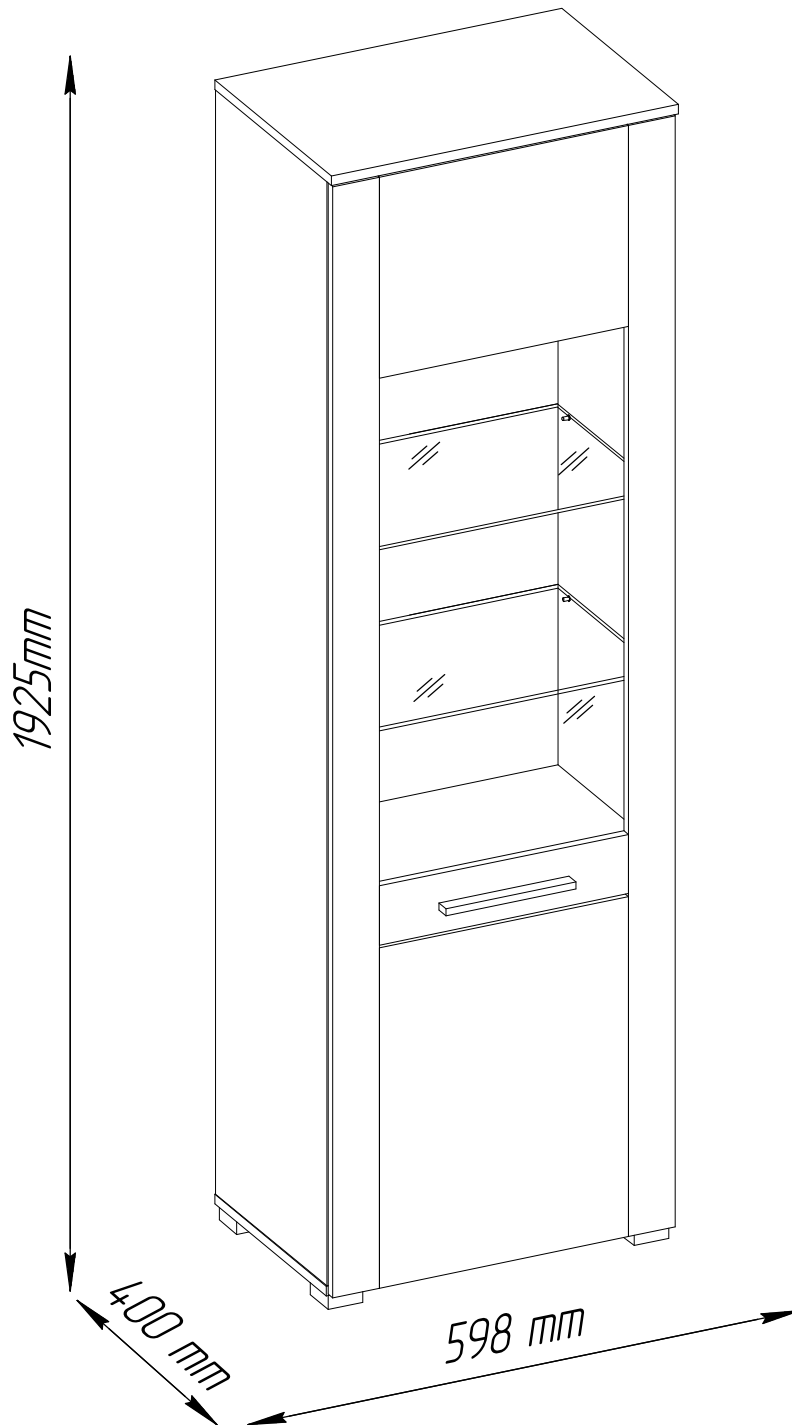

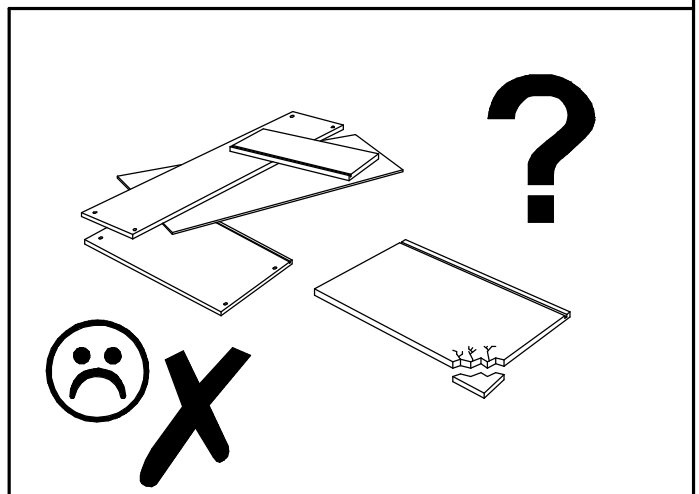

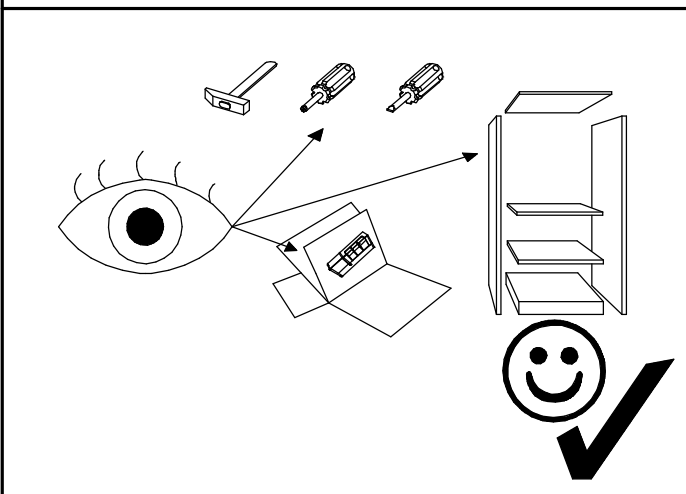
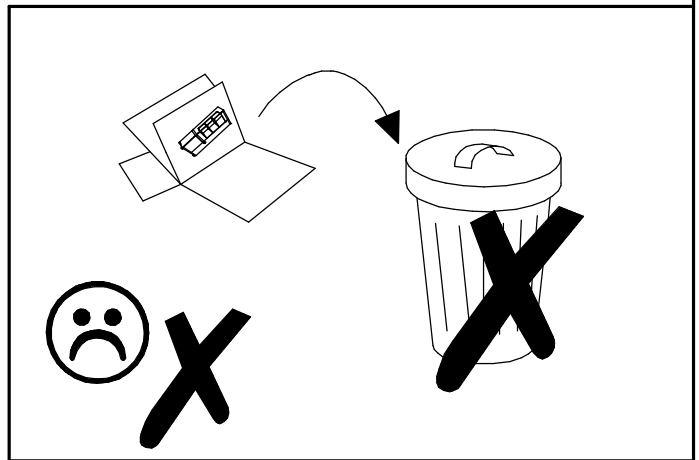
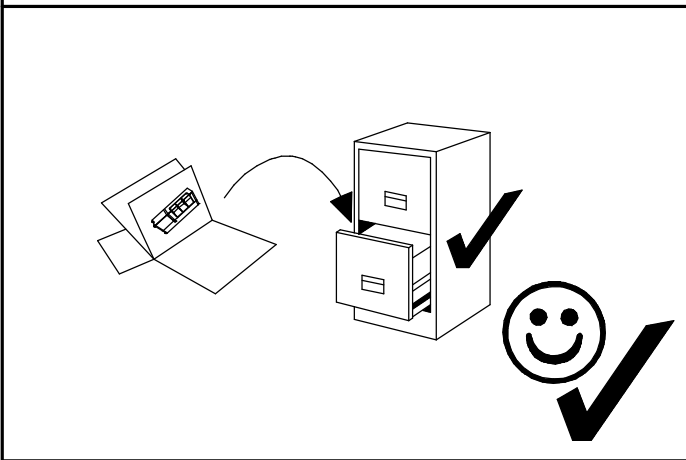
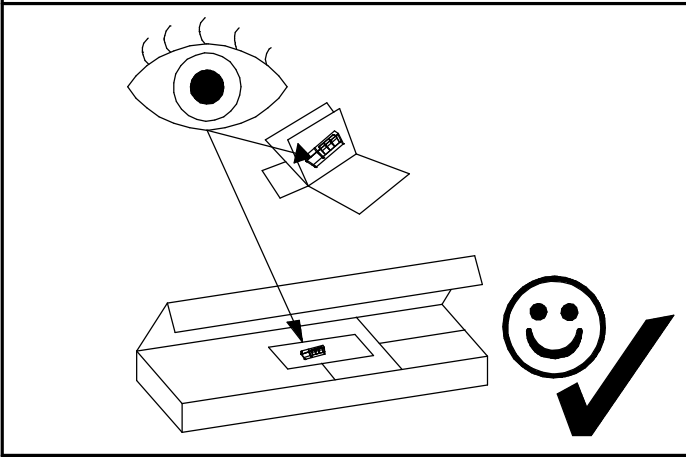
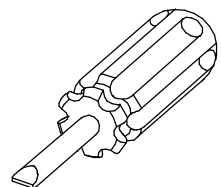
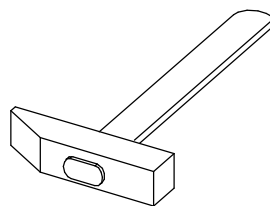
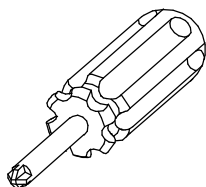
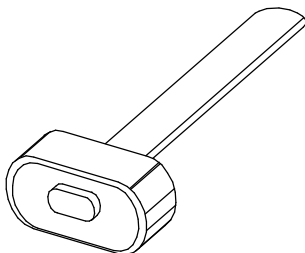
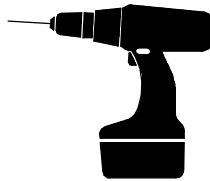
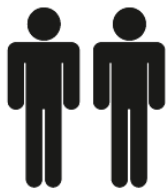
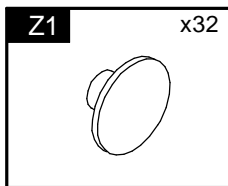
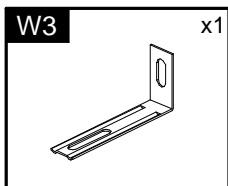
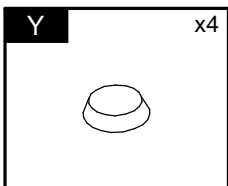
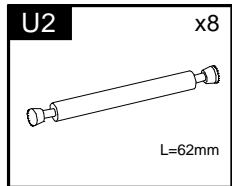
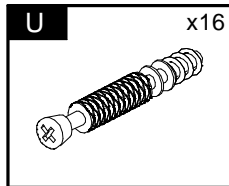
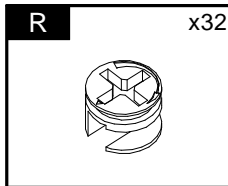
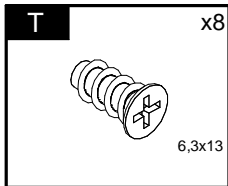
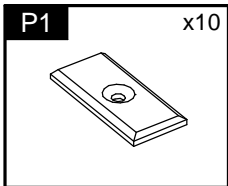
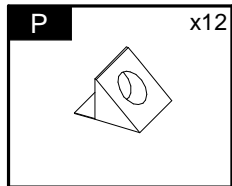
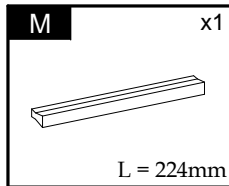
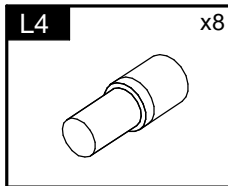
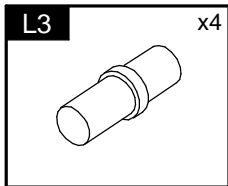
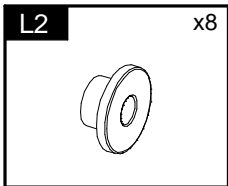
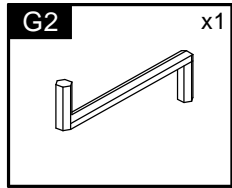
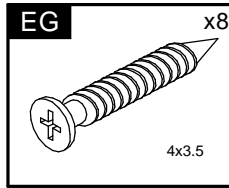
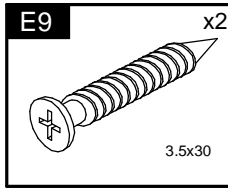
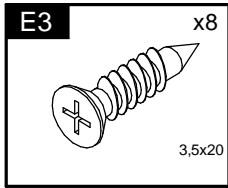
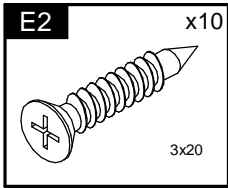
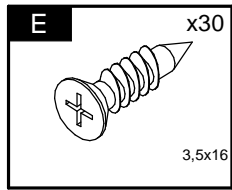
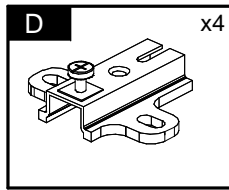
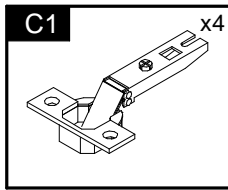
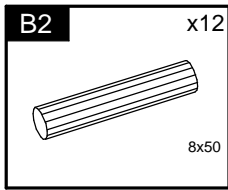
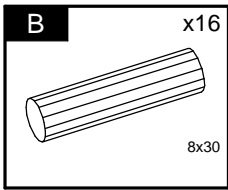
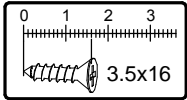
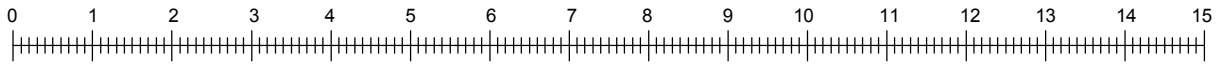

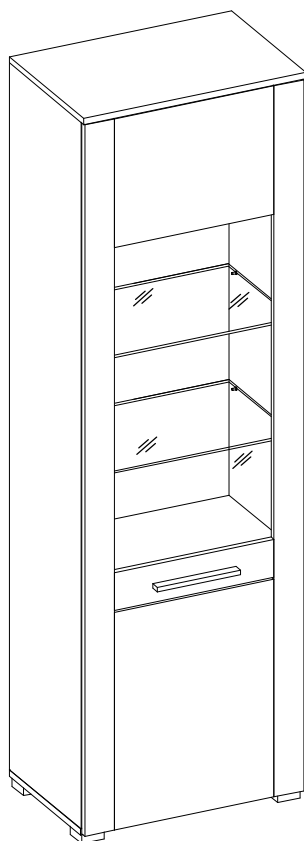

Element symbol	Measurements					Code	Paket
1	598	384	16	1	1002/2002	1/2	
2	598	401	16	1	1003	1/2	
3	1868	383	16	1	1004	1/2	
4	1868	383	16	1	1005	1/2	
5	564	362	16	1	1011	1/2	
6	564	353	16	1	1010	1/2	
7	564	353	16	1	N/A	1/2	
8	578	340	3	1	N/A	1/2	
9	615	578	3	1	N/A	1/2	
10	927	578	3	1	N/A	1/2	
11	1880	81	16	1	1009/3001	1/2	
12	1880	81	16	1	1009/3002	1/2	
13	430	341	16	1	1010/3003	1/2	
14	681	430	16	1	1011/3004	1/2	
15	919	489	4	1	Glass	2/2	
16	563	353	6	2	Glass	2/2	

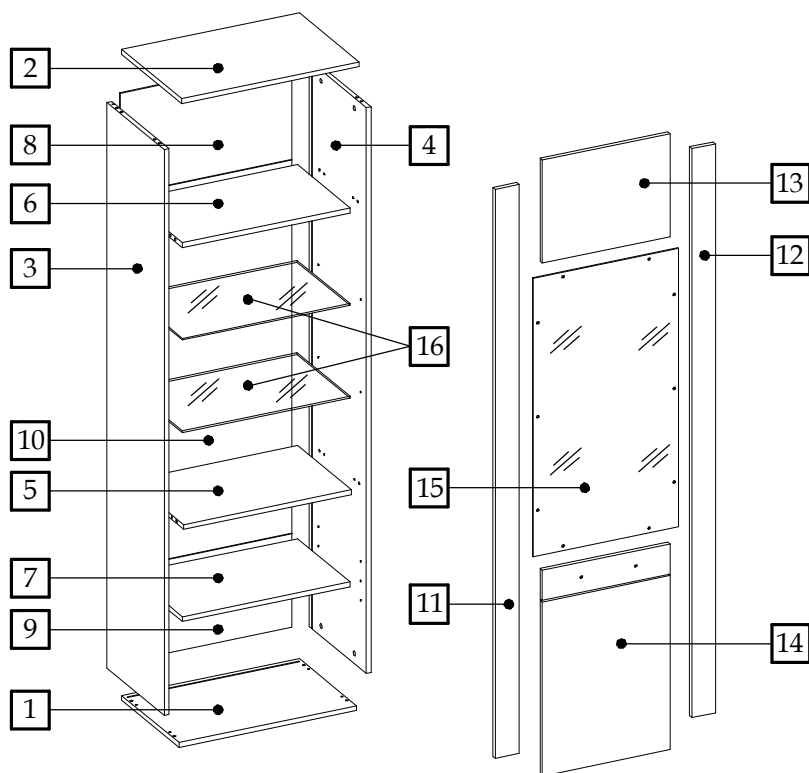

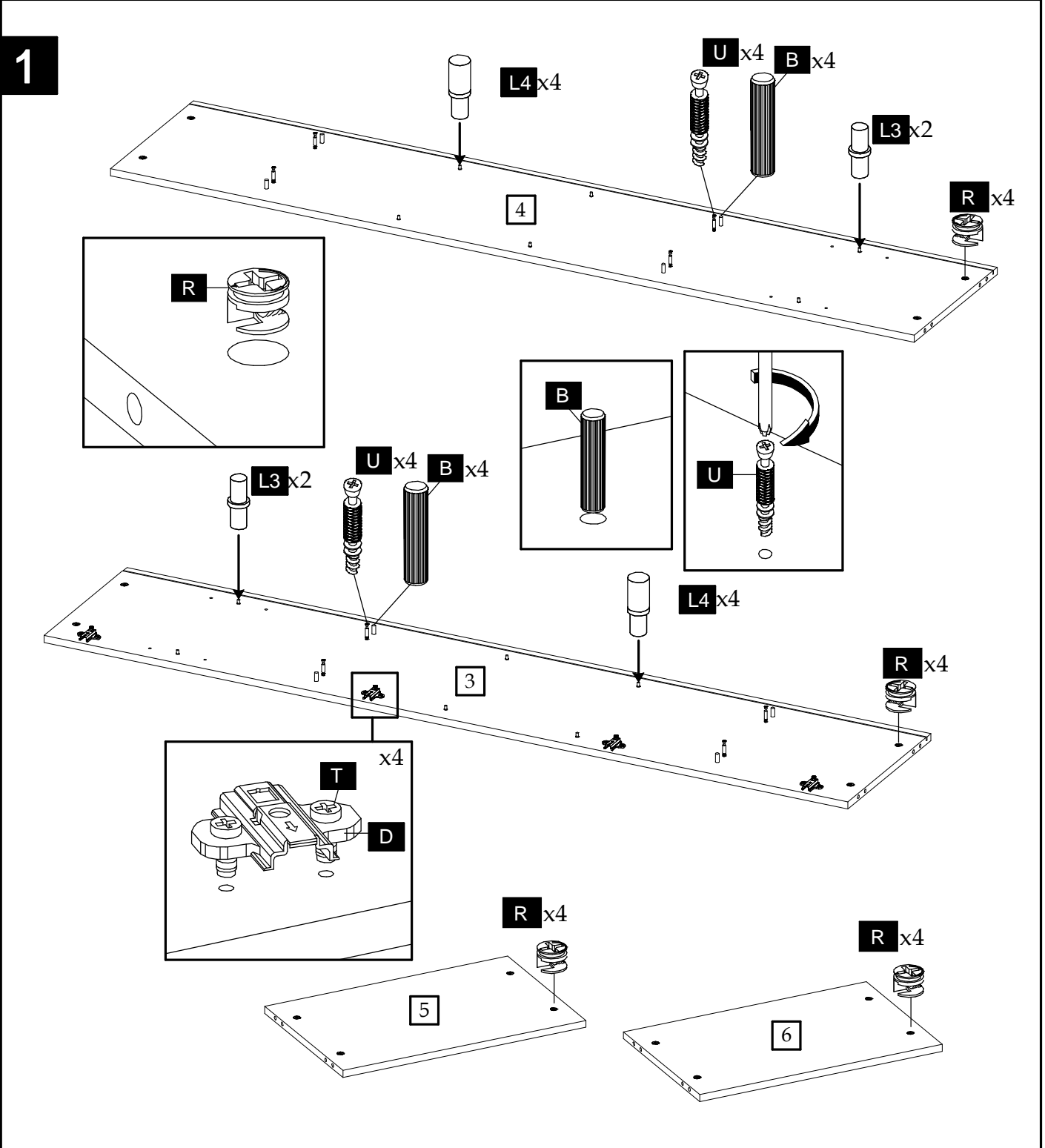

2

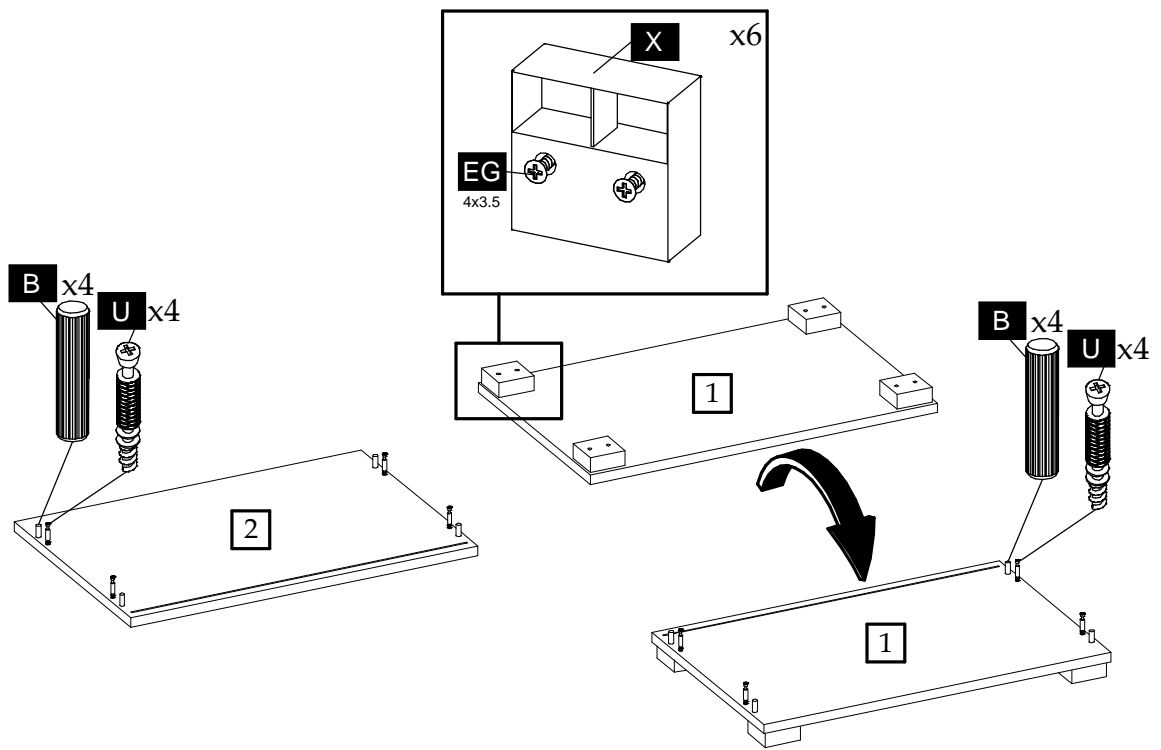

3

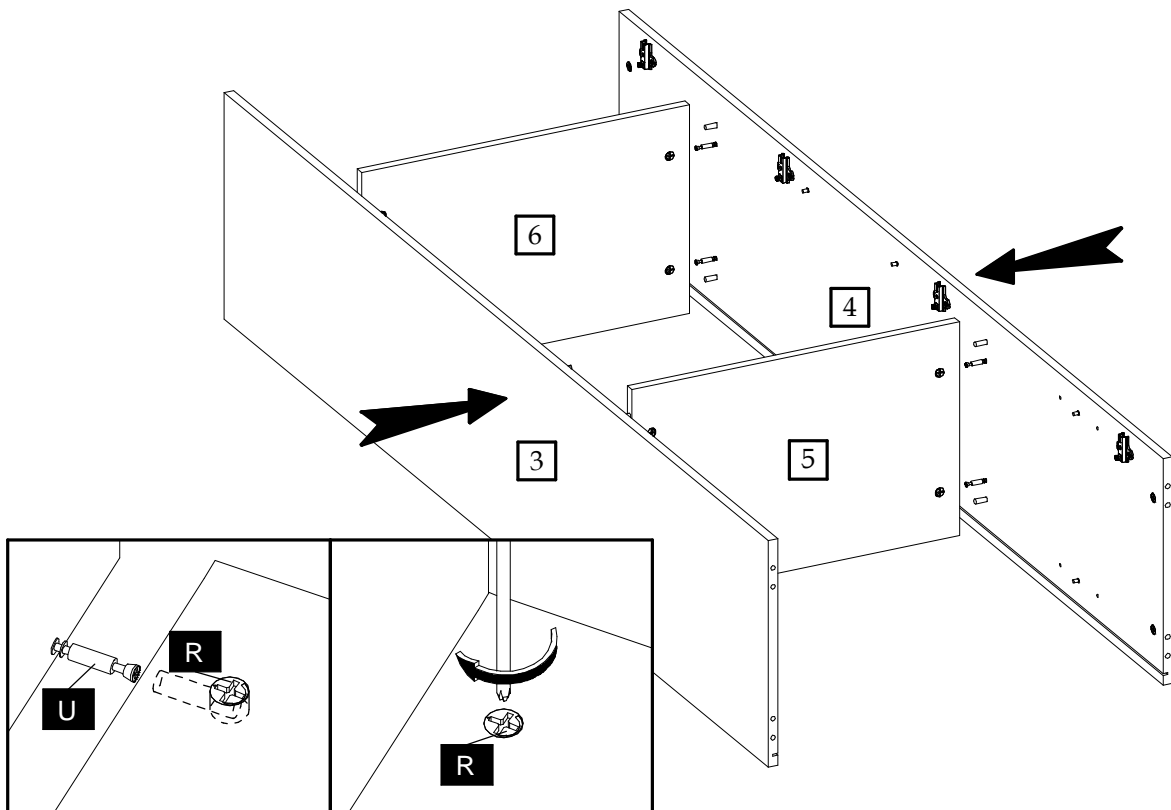

4

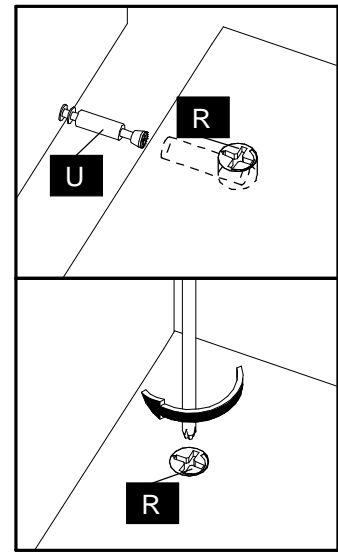
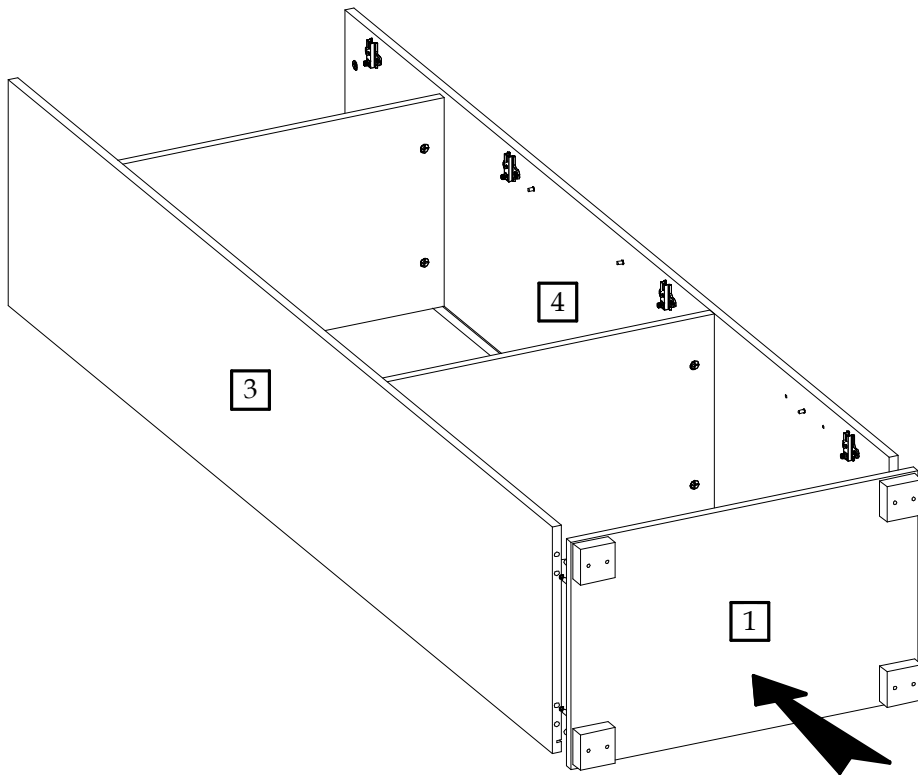

5

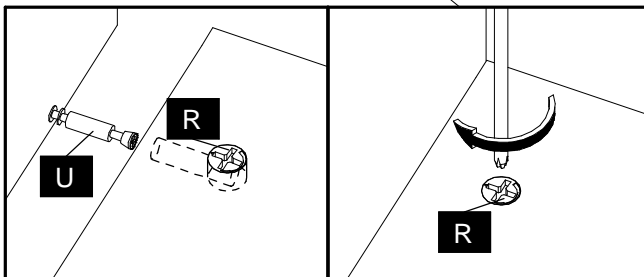
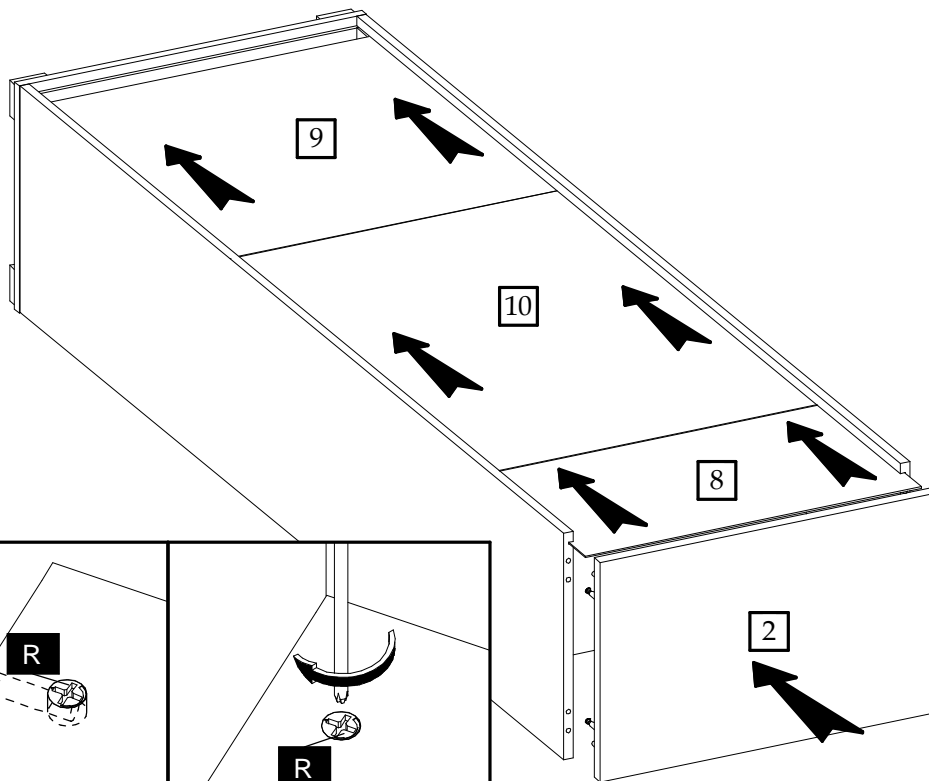

6

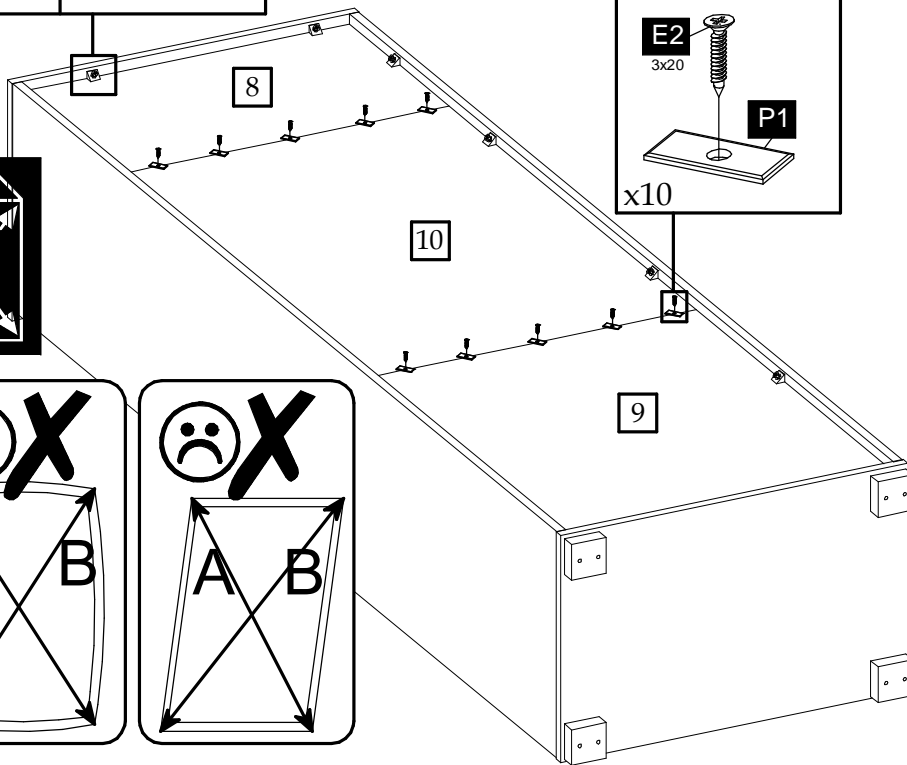
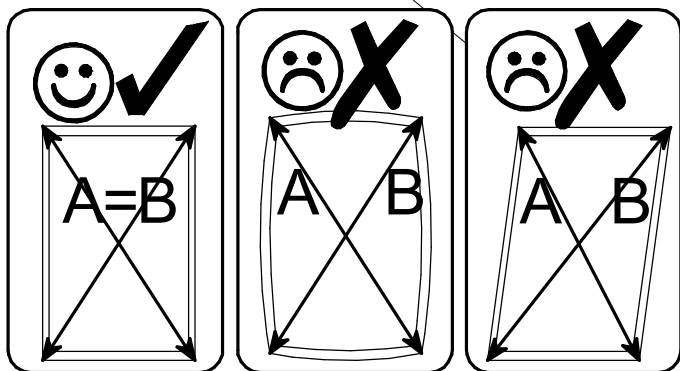
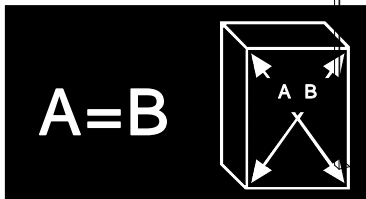
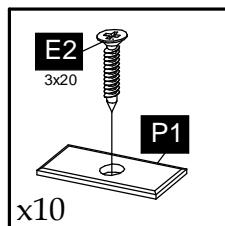
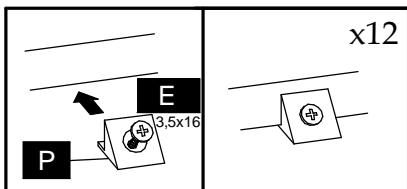

7

