

HILL

Typ Q

INDEKS 3323411

PL 36UO SZAFKA HILL Q 4D2S

SK 36UO SKRINA HILL Q 4D2S

CZ 36UO SKŘÍŇ HILL Q 4D2S

HU Szekrény HILL Q 4D2S rendszer

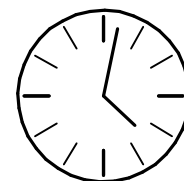
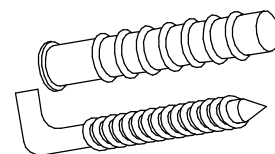

100 min

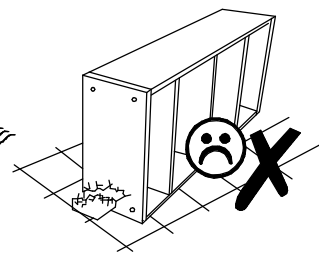
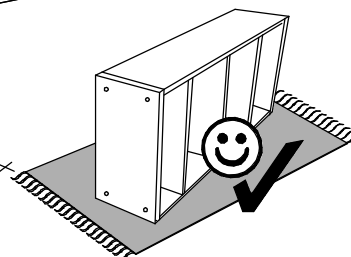
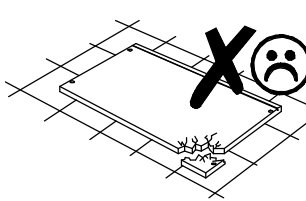
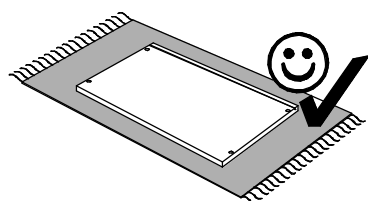
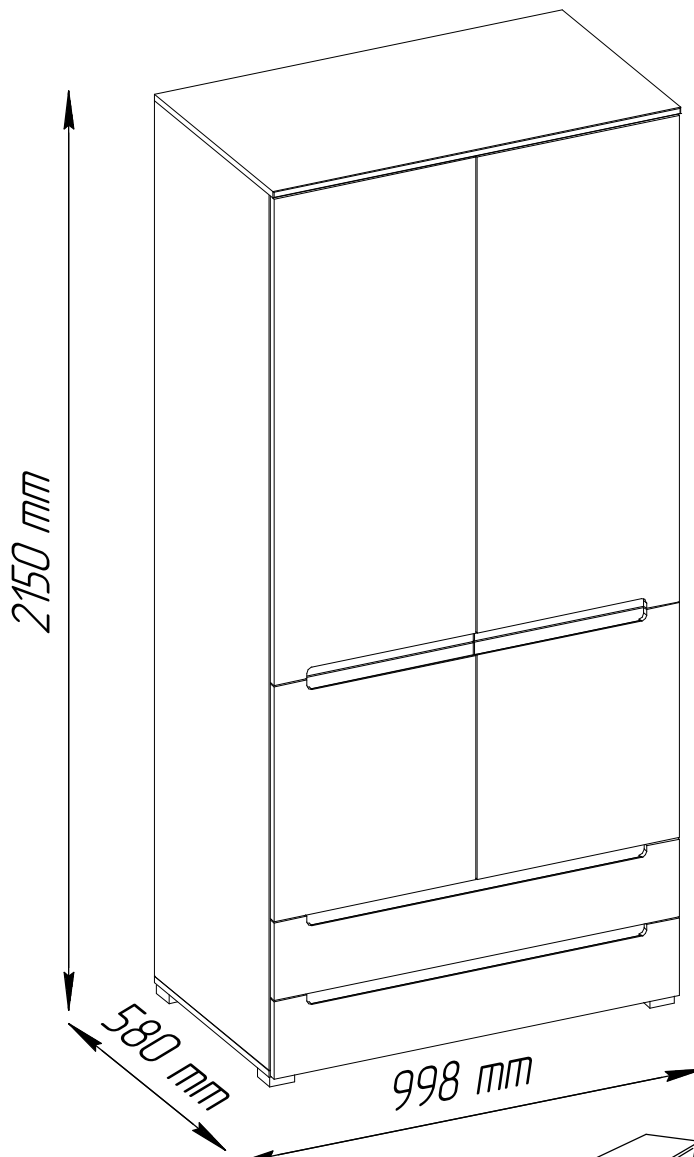
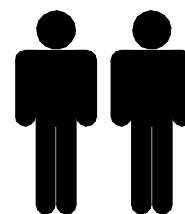

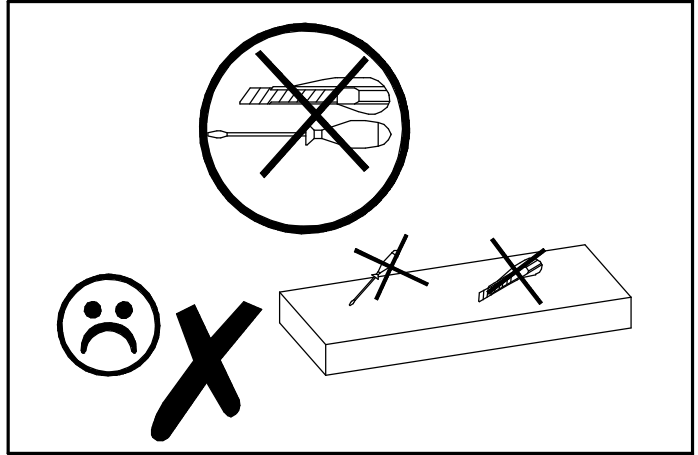
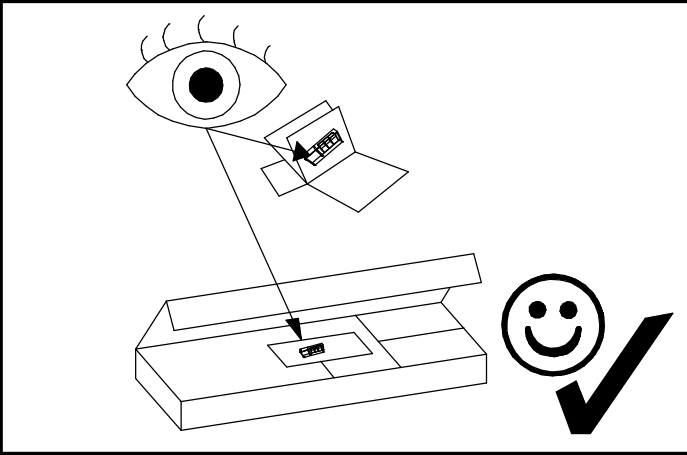

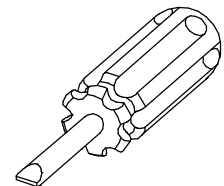
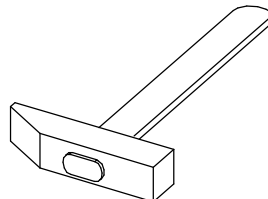
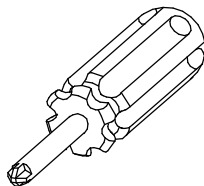
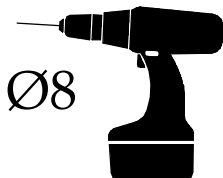
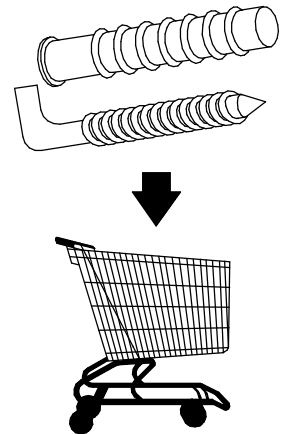
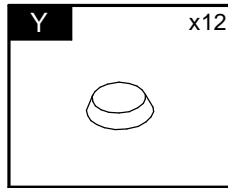
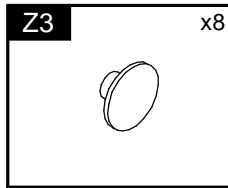
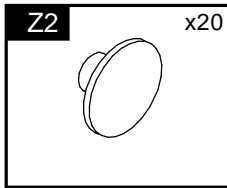
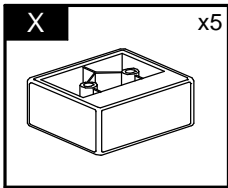
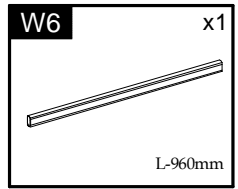
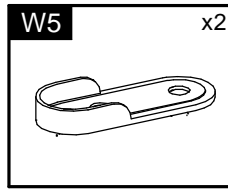
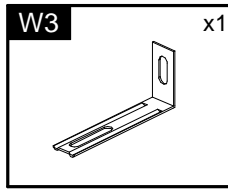
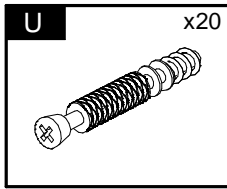
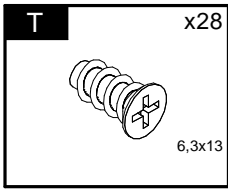
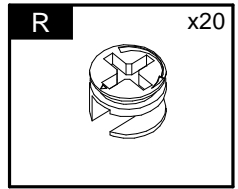
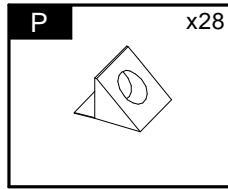
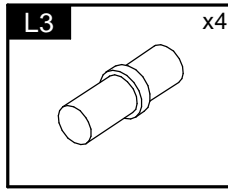
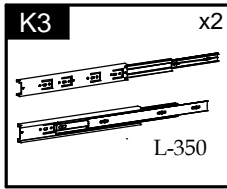
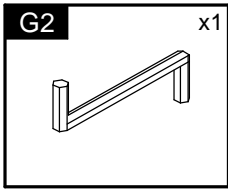
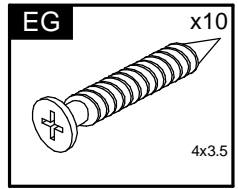
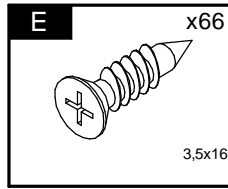
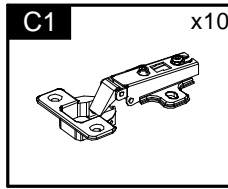
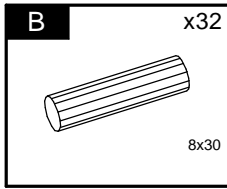
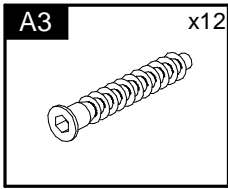
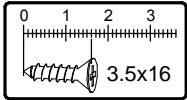

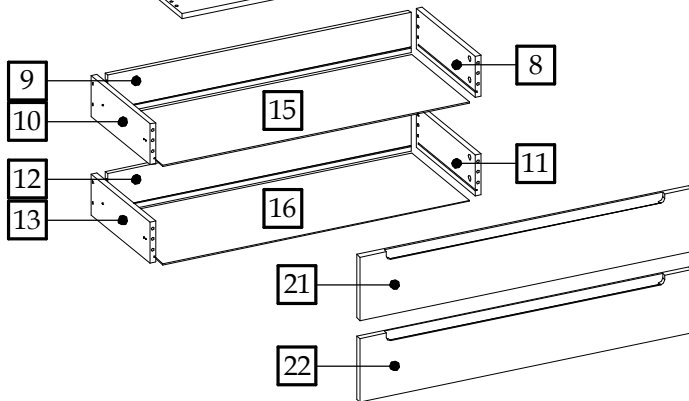
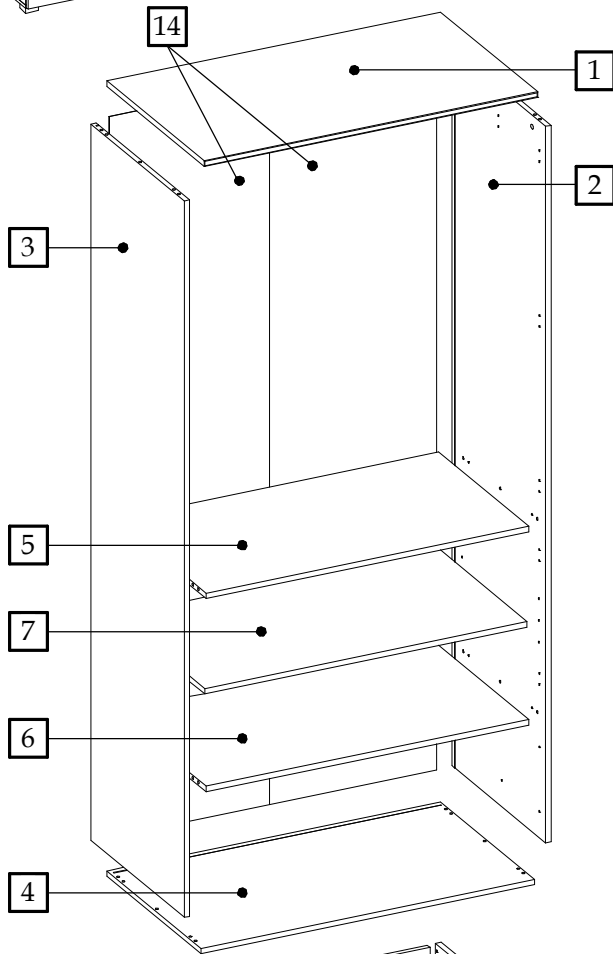
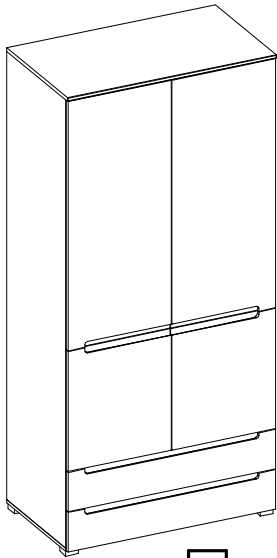

Element Symbol Szymbylum	Rozmiar Rozmer Dimenzij Measurements				Code Kod Kyd	Paket
1	998	580	16	1	1004	1/3
2	2103	559	16	1	1001	2/3
3	2103	559	16	1	1002	2/3
4	998	560	16	1	1003/2003	1/3
5	964	538	16	1	1055	1/3
6	964	538	16	1	1066	1/3
7	964	529	16	1	N/A	1/3
8	350.5	120	16	1	1057/2057	1/3
9	906.5	119	16	1	1058	1/3
10	350.5	120	16	1	1059/2059	1/3
11	350.5	120	16	1	1062/2062	1/3
12	906.5	119	16	1	1063	1/3
13	350.5	120	16	1	1064/2064	1/3
14	2117	489	3	2	N/A	2/3
15	916	343	3	1	N/A	3/3
16	916	343	3	1	N/A	3/3
17	1170	496.5	19	1	1018/3001	3/3
18	1170	496.5	19	1	1019/3002	3/3
19	566	496.5	19	1	1020/3003	3/3
20	566	496.5	19	1	1021/3004	3/3
21	994	188	19	1	1022/3005	3/3
22	994	188	19	1	1022/3006	3/3

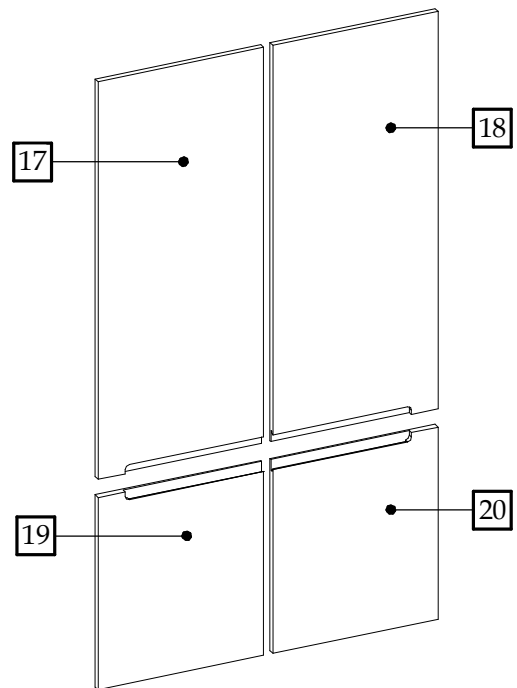



1

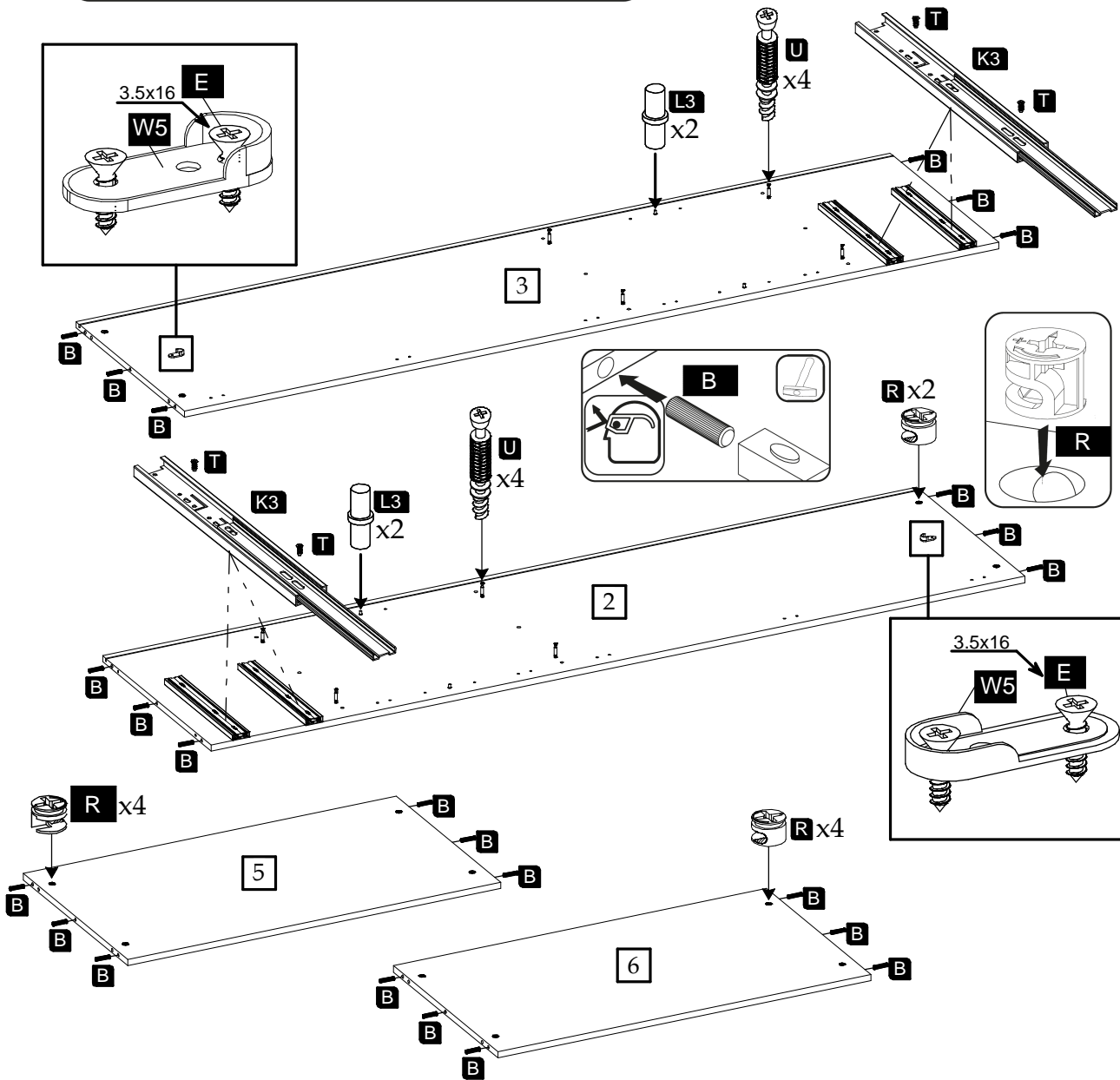
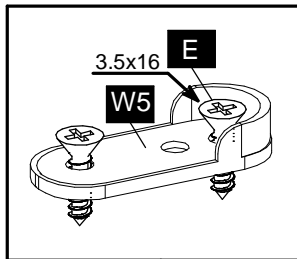
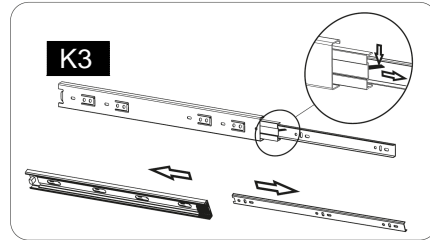
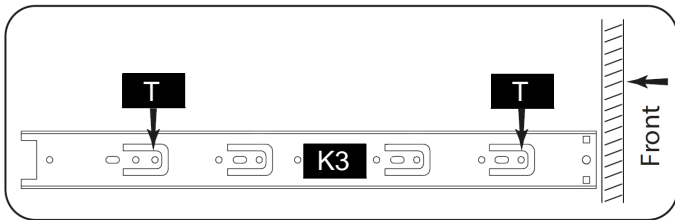

2

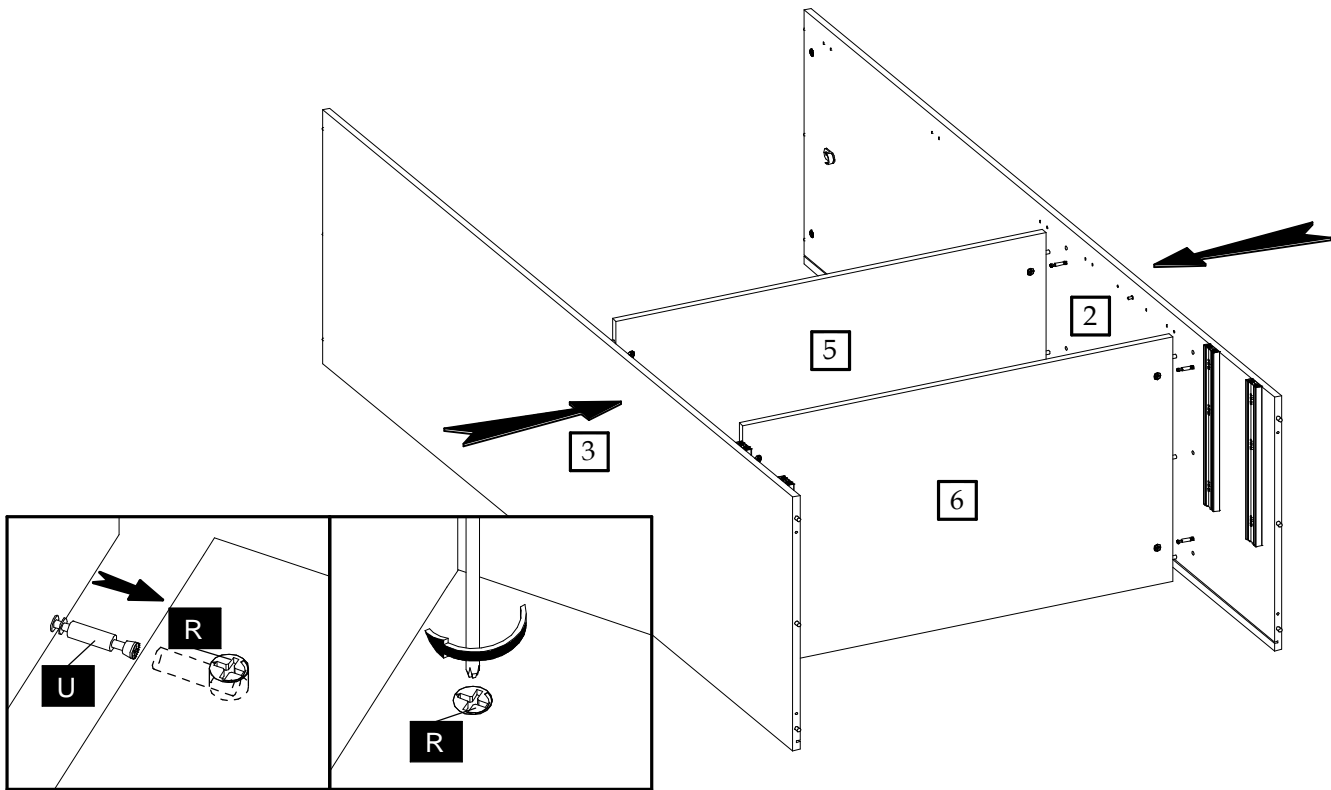

3

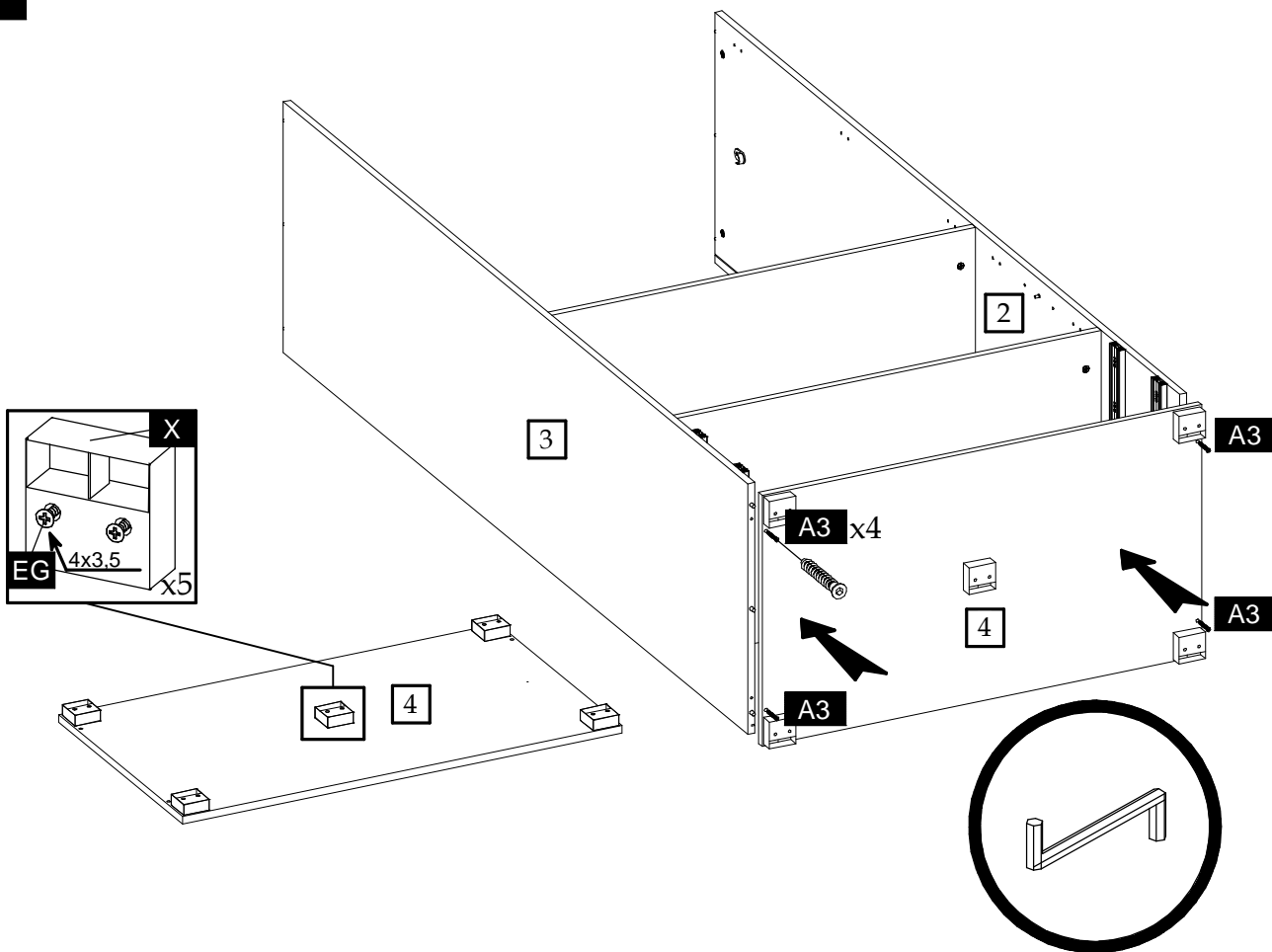

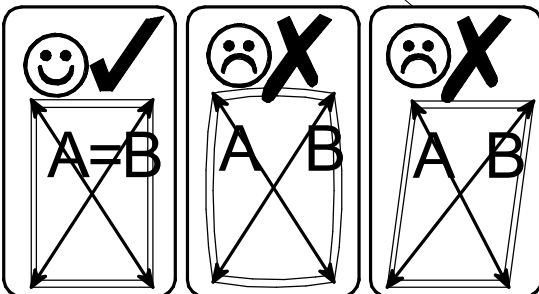
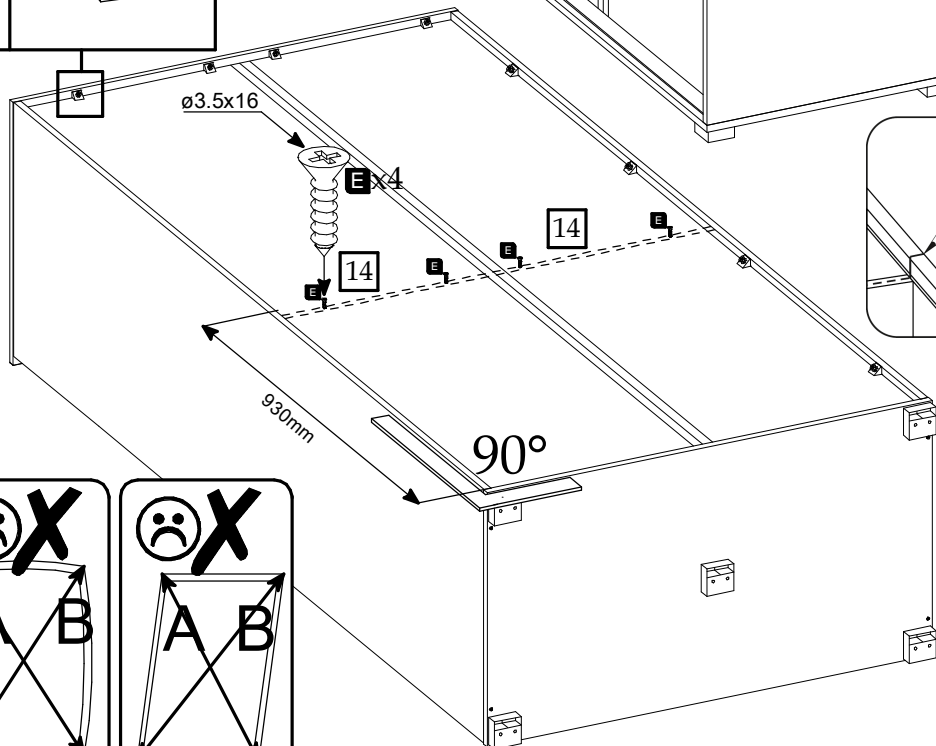
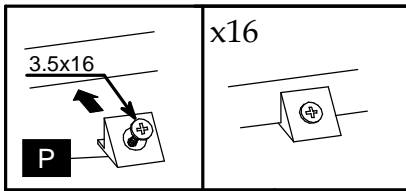
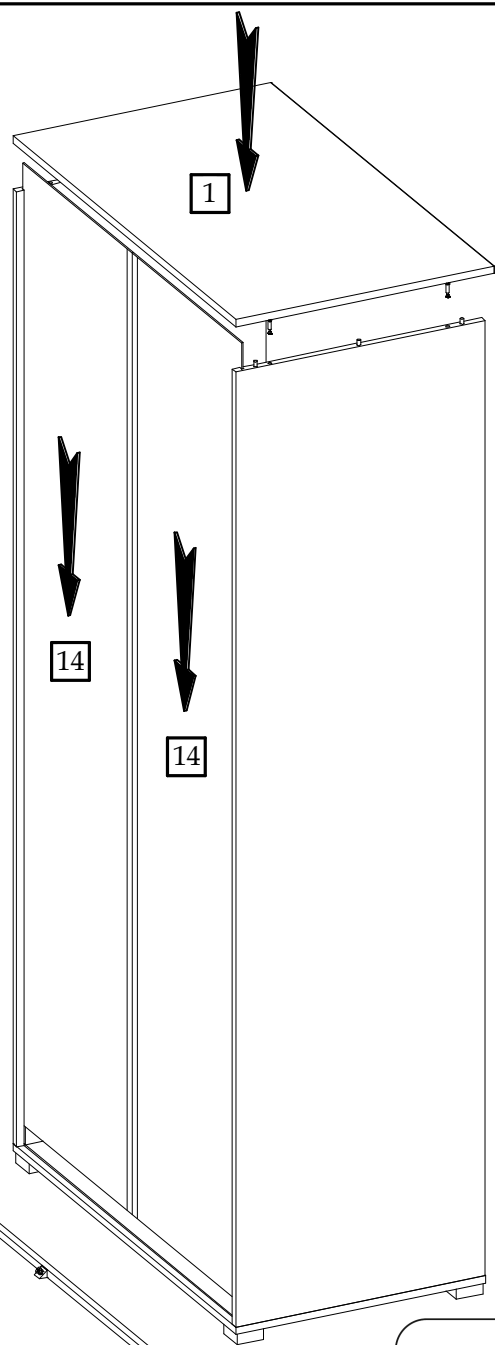
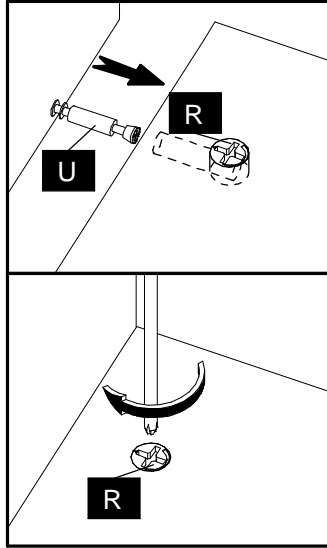
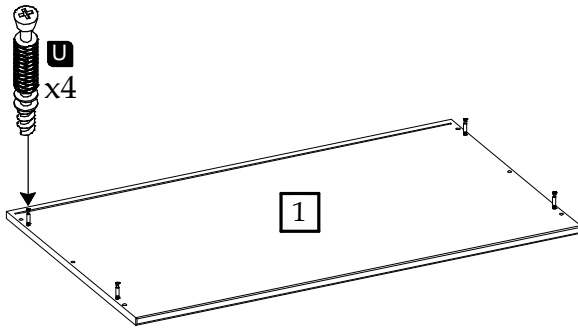

5

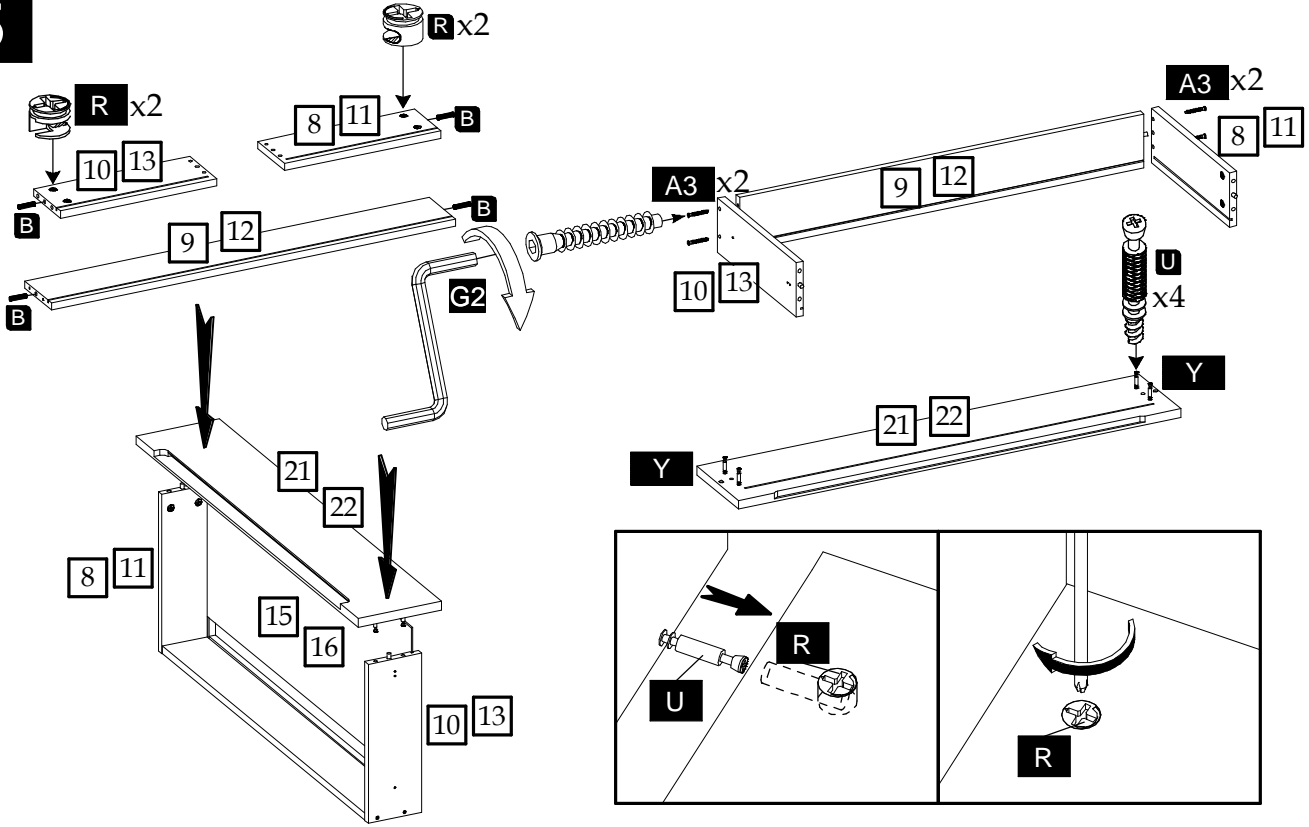

6

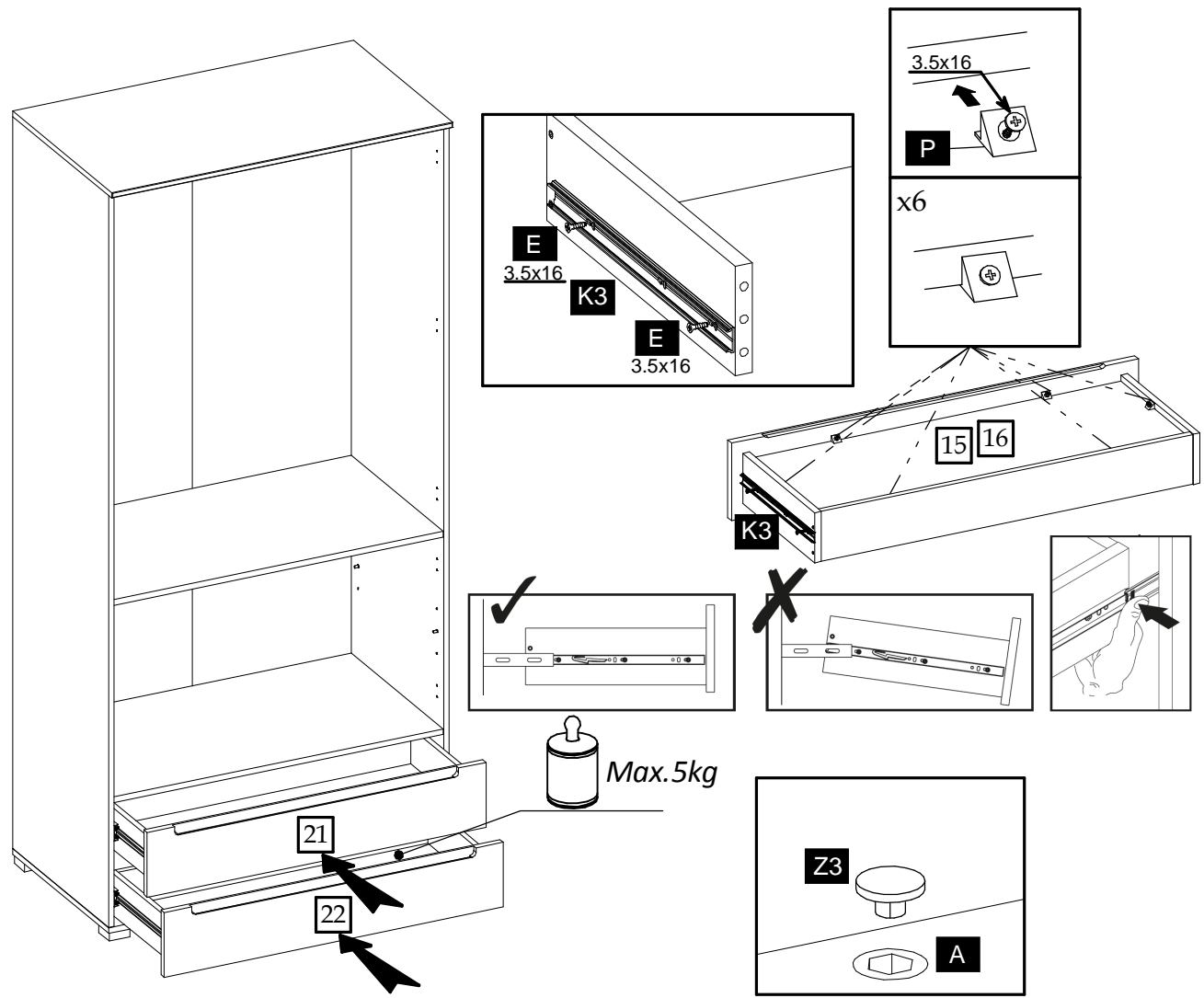

7

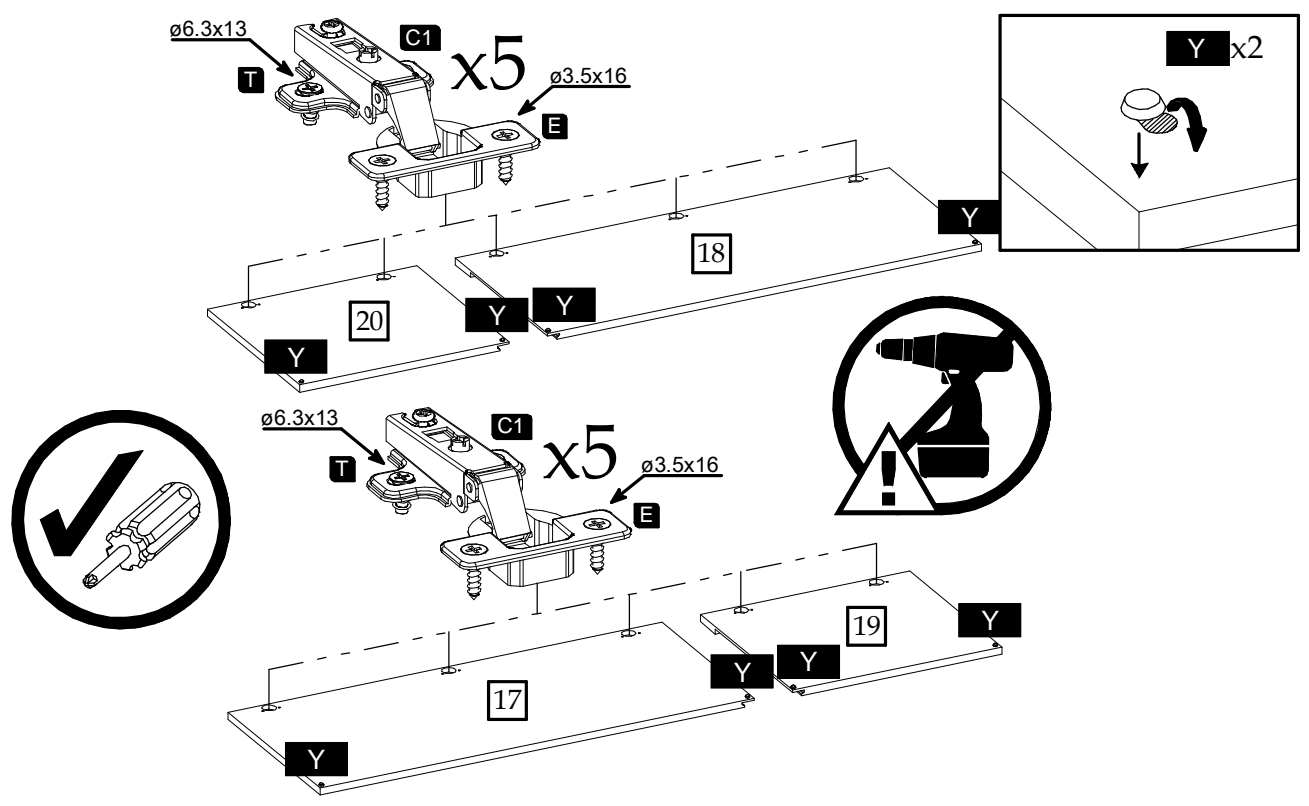

8

