

HILL X

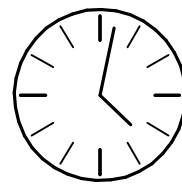

50 min

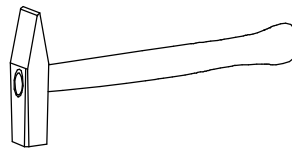
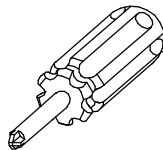
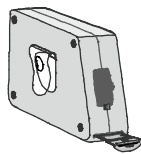
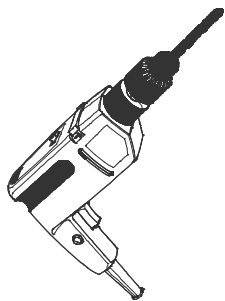
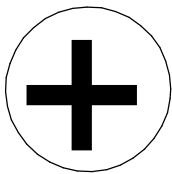

INDEX 3371242



PL: 36UO+STOLIK NOCNYHILL X 2SZ



SK: 36UO+NOČNÝ STOLÍKHILL X 2SZ



CZ: 36UO+NOČNÍ STOLEK HILL X 2SZ

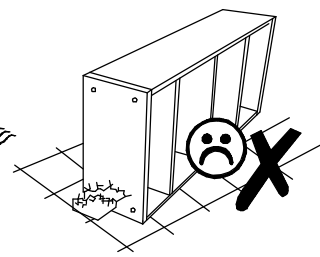
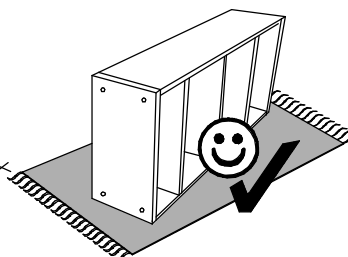
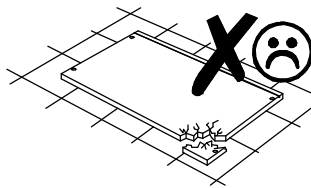
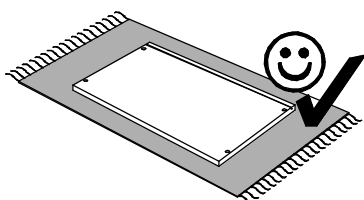
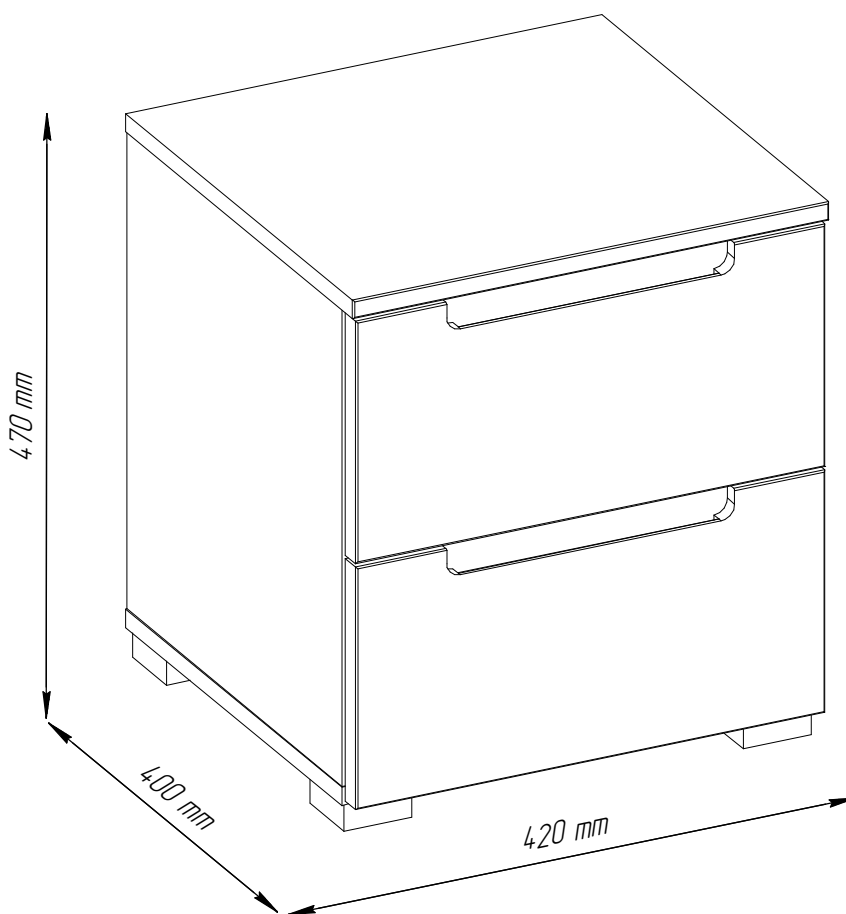

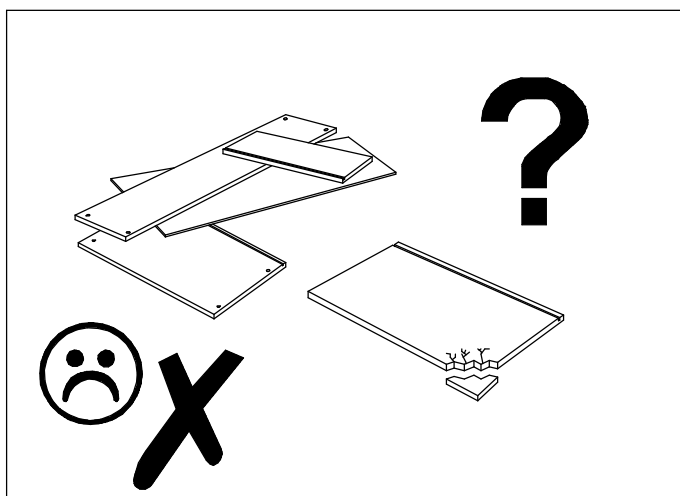
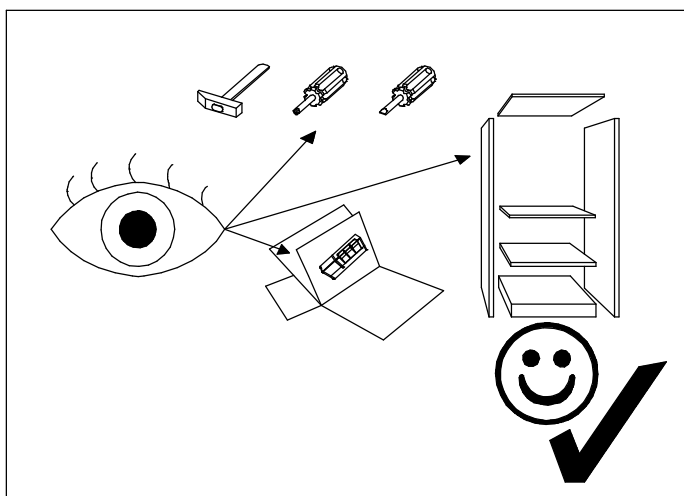
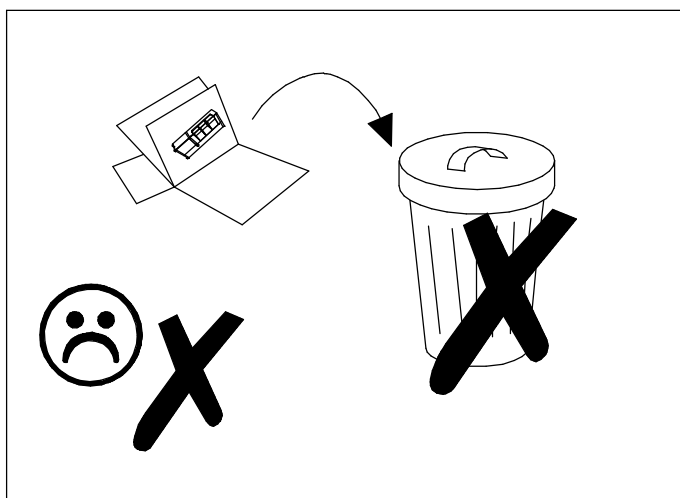
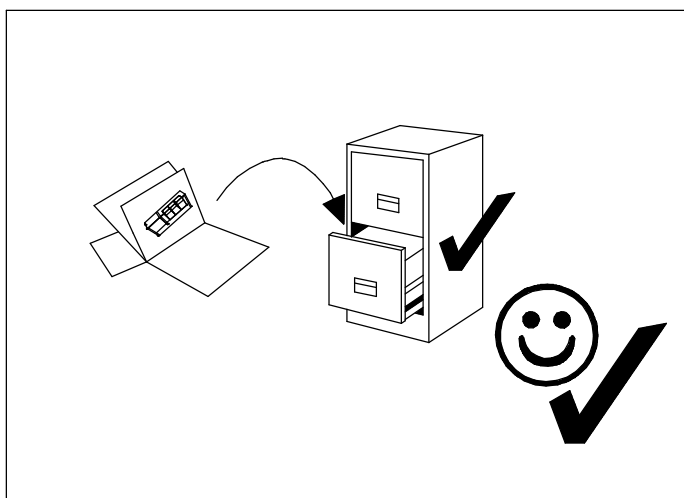
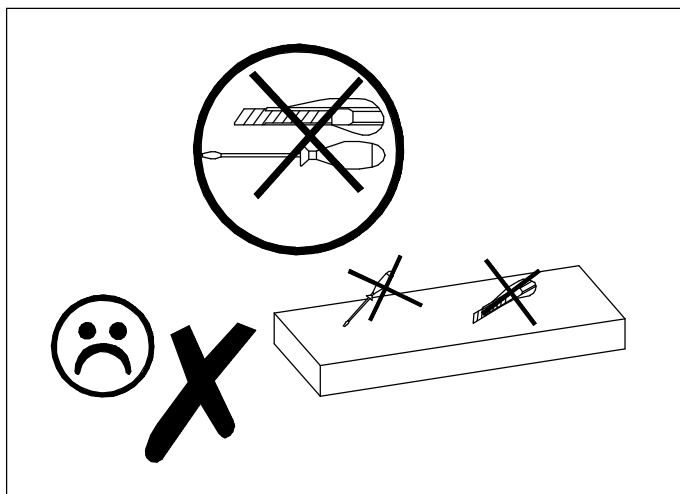
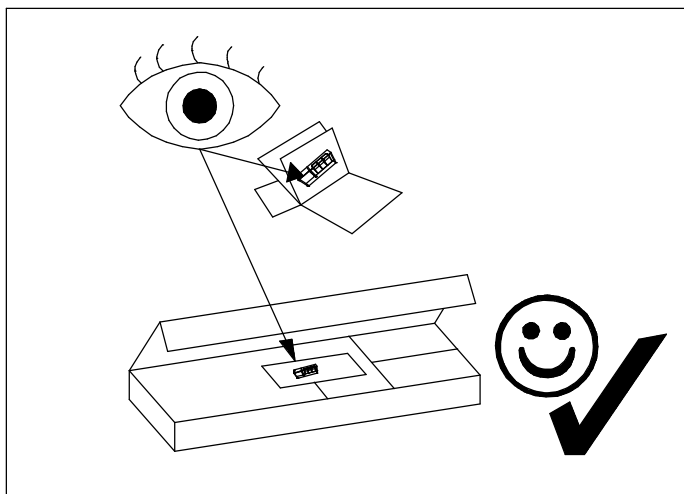

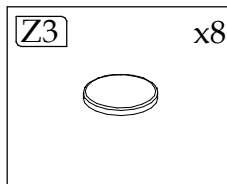
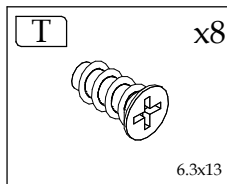
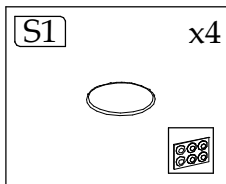
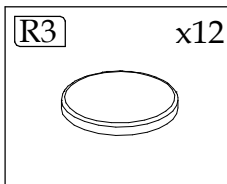
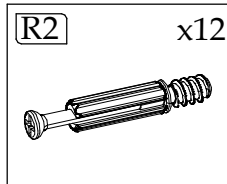
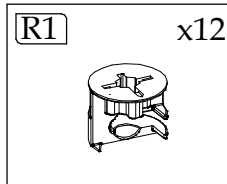
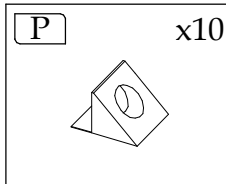
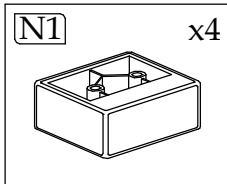
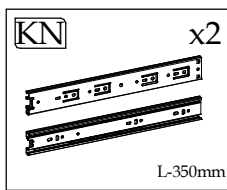
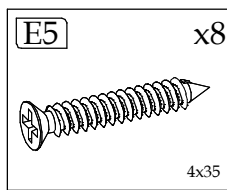
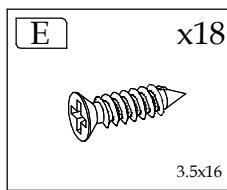
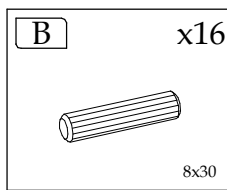
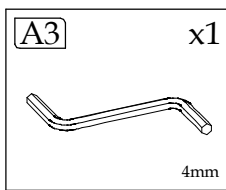
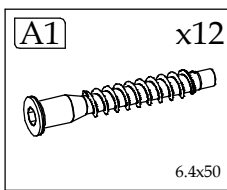

Element symbol	Measurements				Code	Paket
	1	2	3	4		
1	420	400	16	1	1004	1/1
2	413	379	16	1	1001	1/1
3	413	379	16	1	1002	1/1
4	420	380	16	1	1003/2003	1/1
5	350.5	120	16	1	1007/2007	1/1
6	328.5	119	16	1	1008	1/1
7	350.5	120	16	1	1009/2009	1/1
8	350.5	120	16	1	1012/2012	1/1
9	328.5	119	16	1	1013	1/1
10	350.5	120	16	1	1014/2014	1/1
11	427	400	3	1	N/A	1/1
12	338	343	3	1	N/A	1/1
13	338	343	3	1	N/A	1/1
14	416	212	19	1	1029/3001	1/1
15	416	212	19	1	1029/3002	1/1

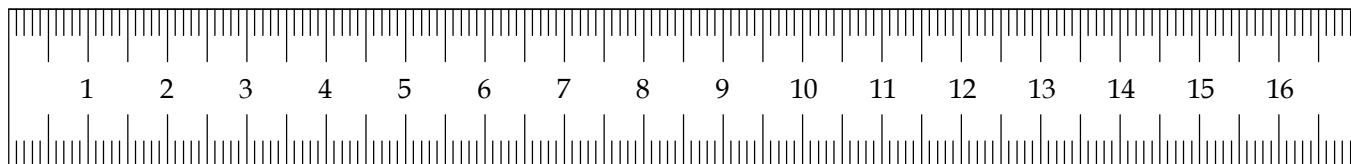
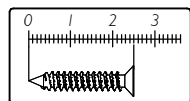
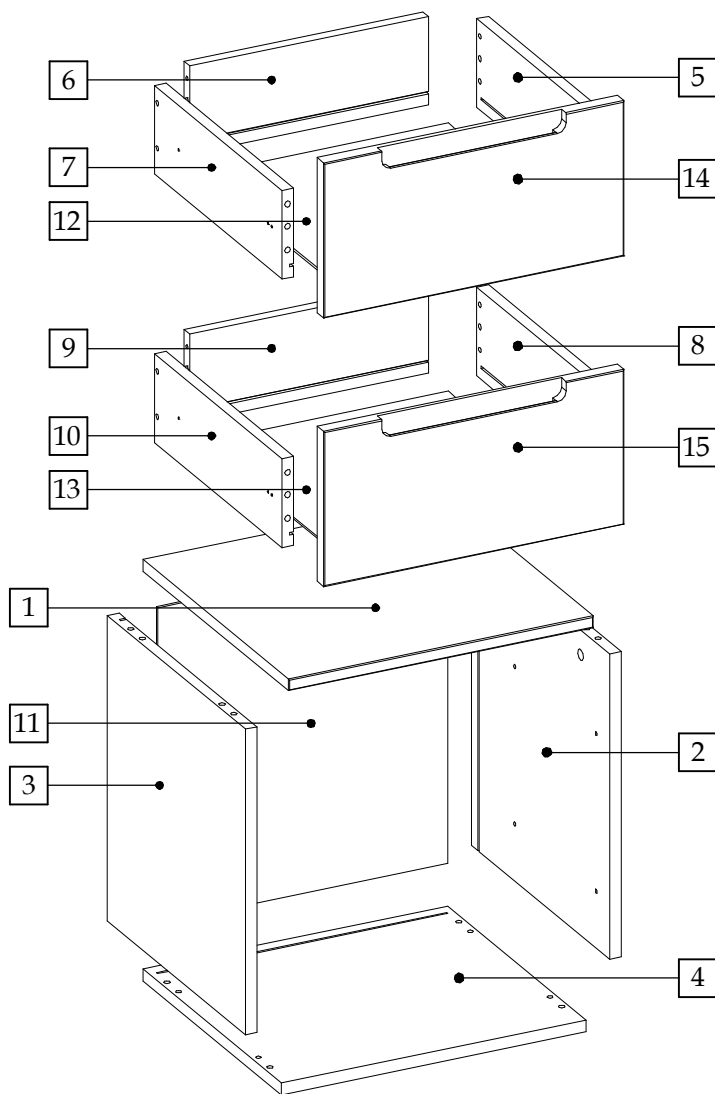

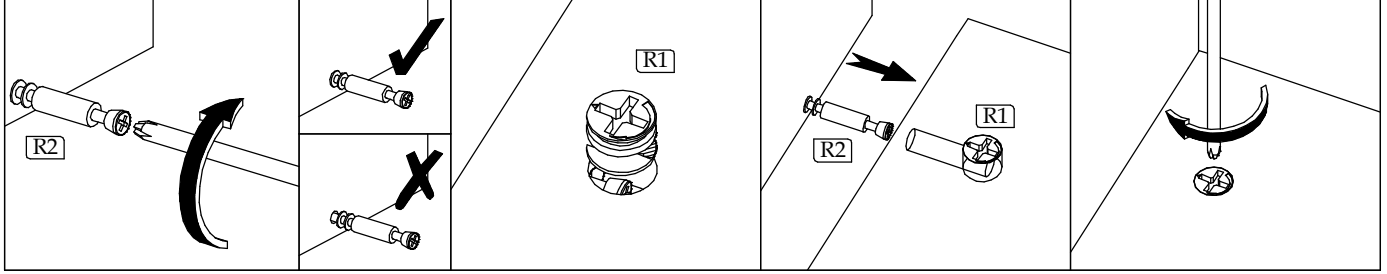

▶ 1

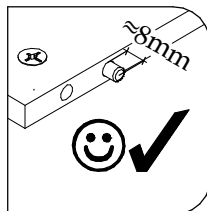
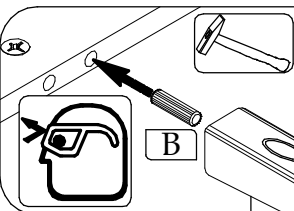
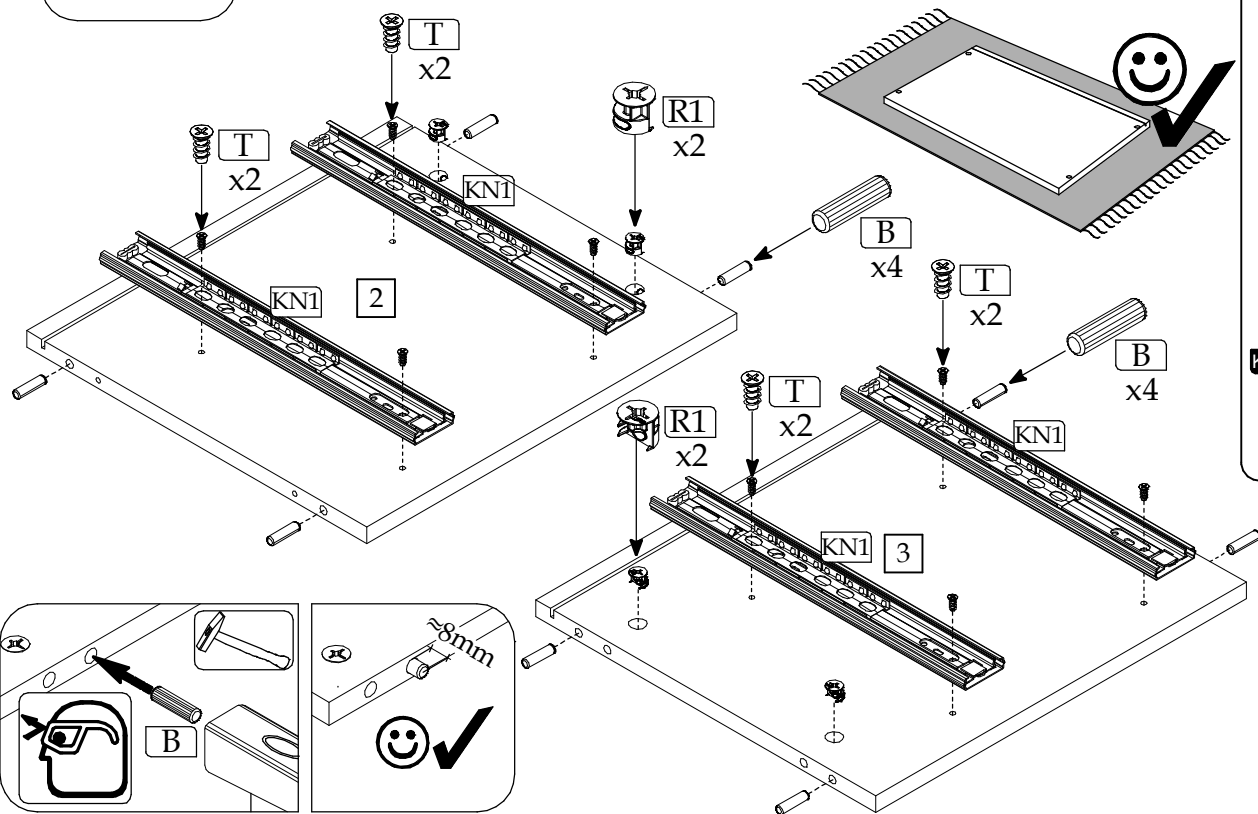
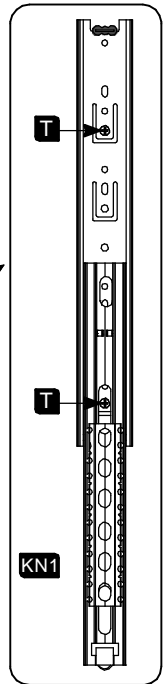
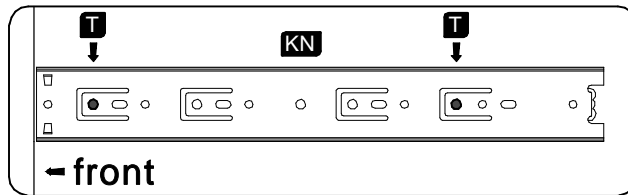
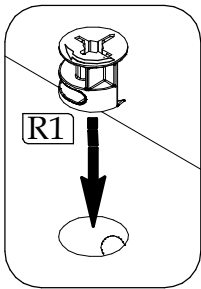
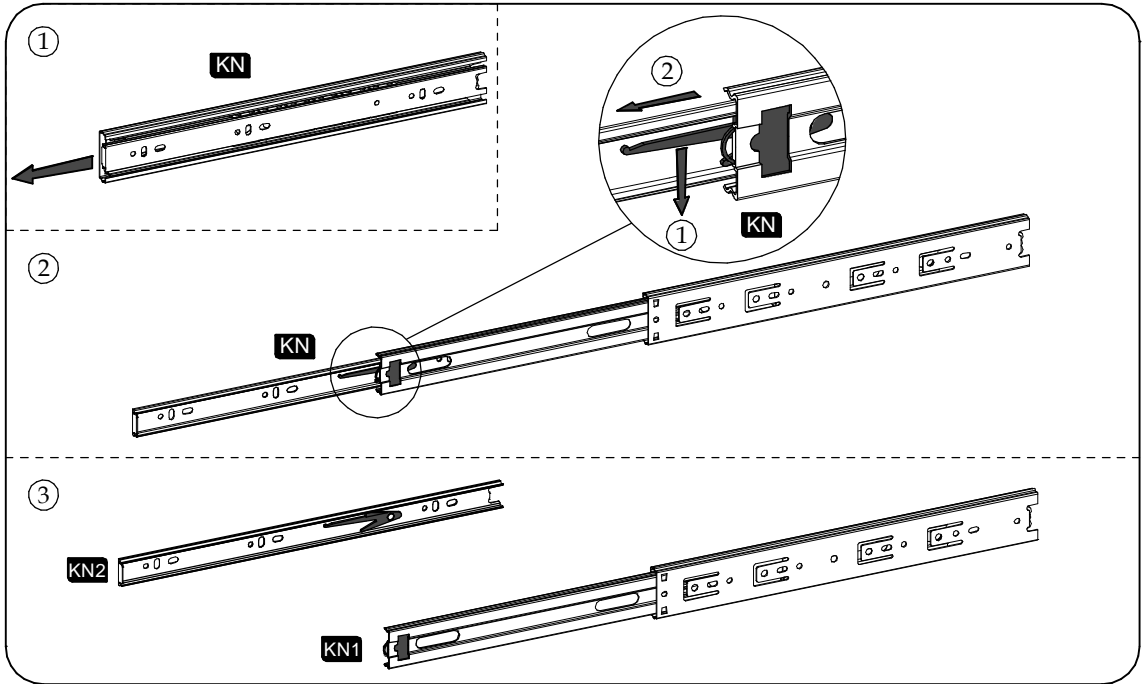

▶ 2

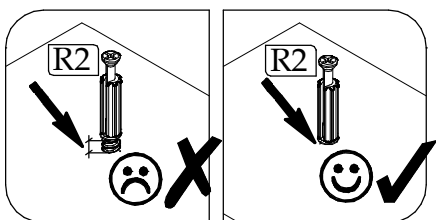
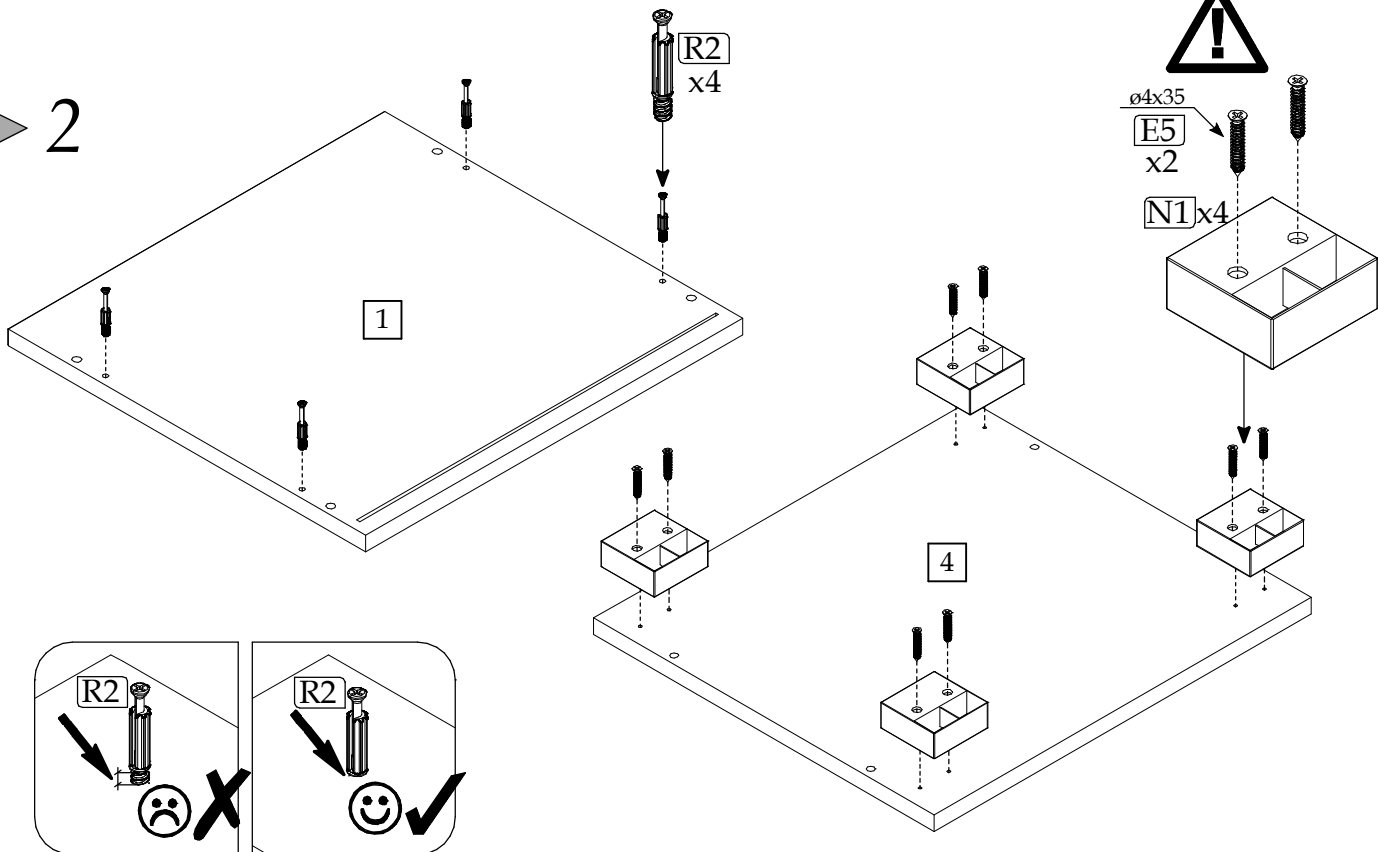

▶ 3

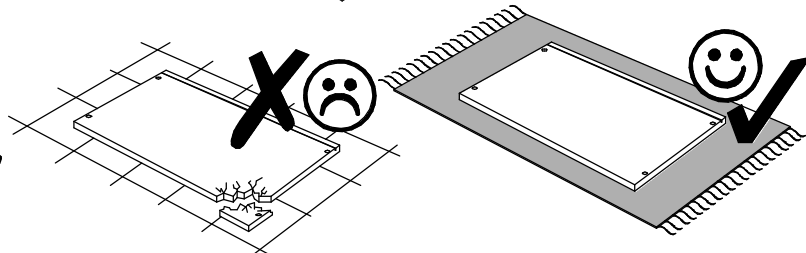
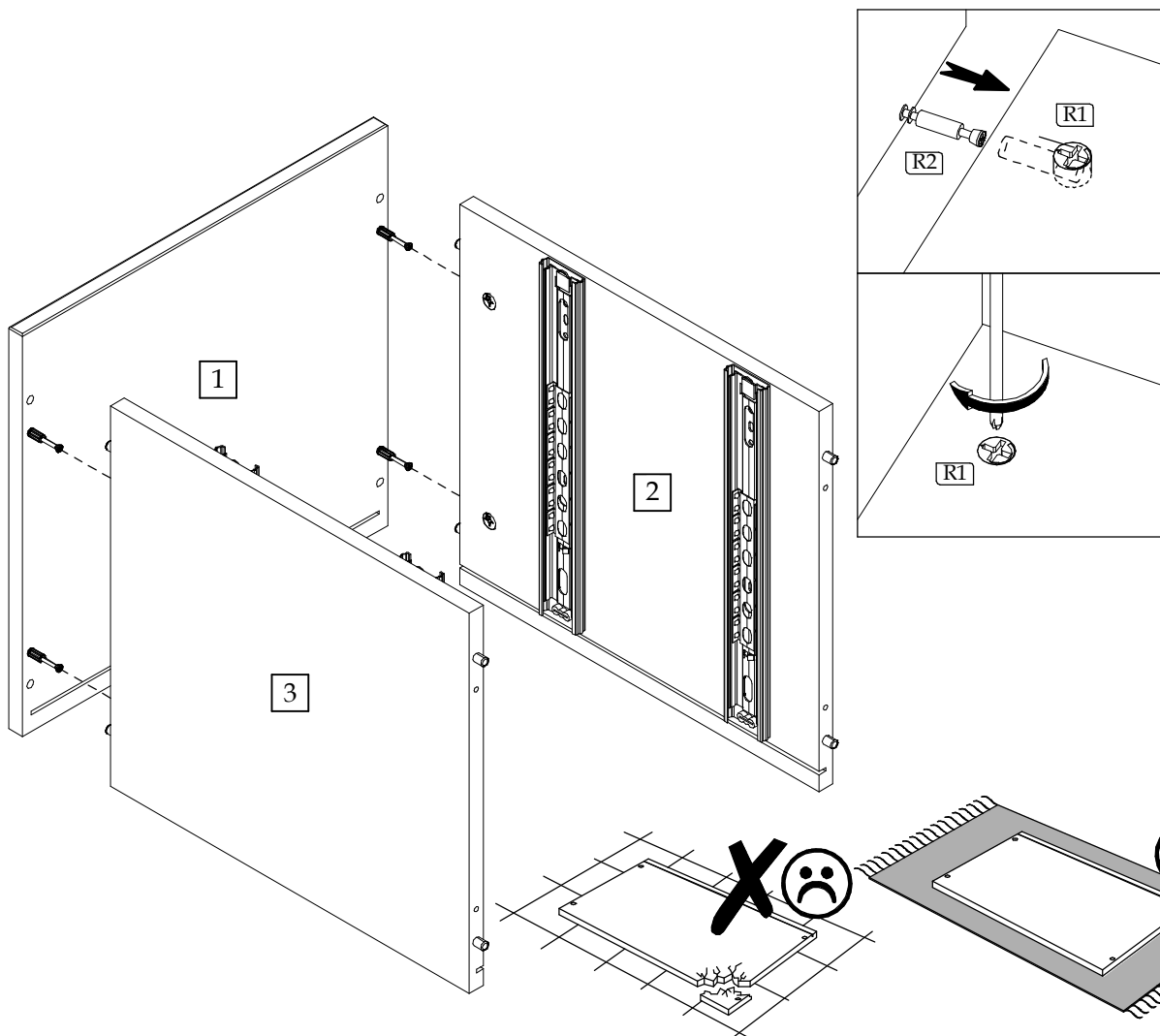

▶ 4

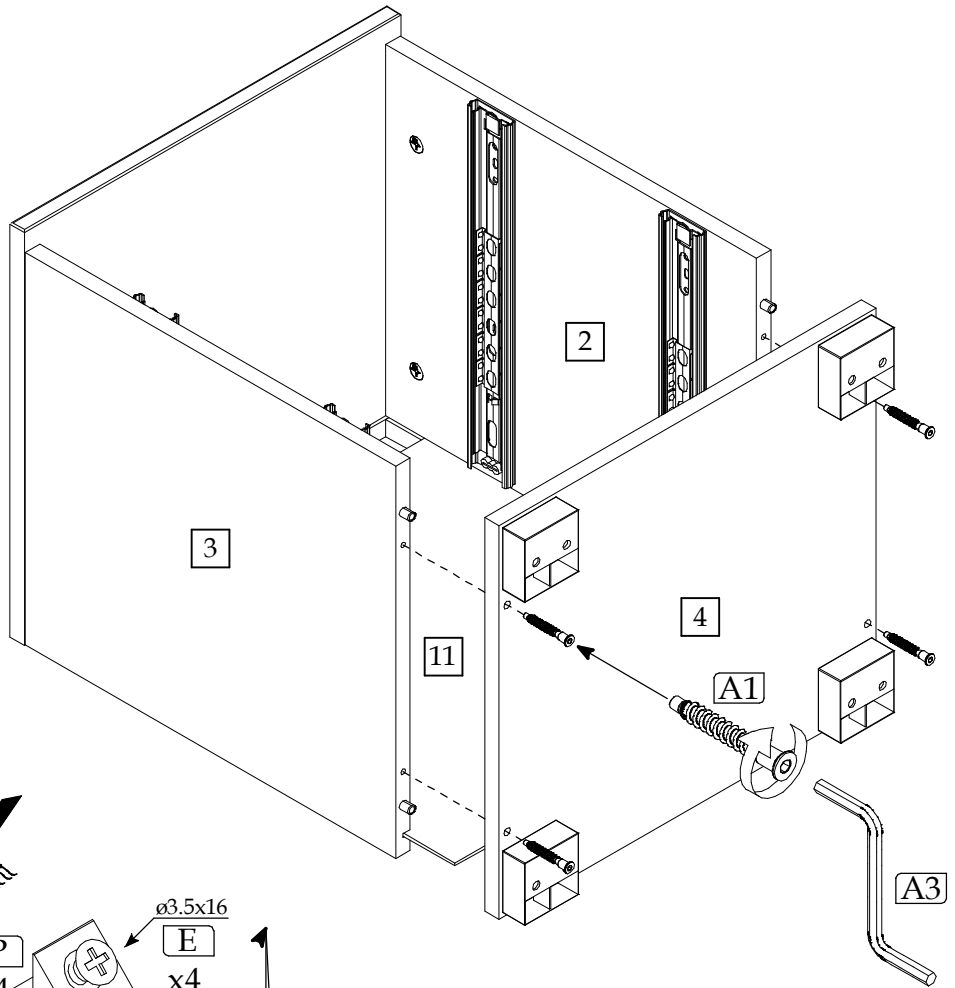
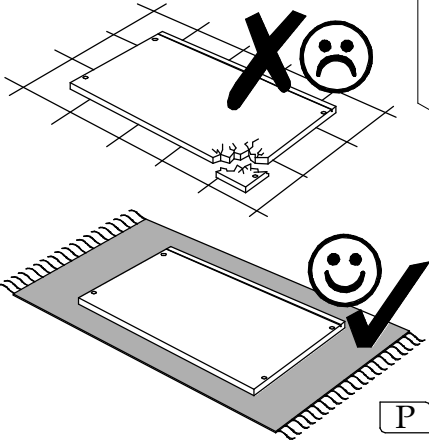
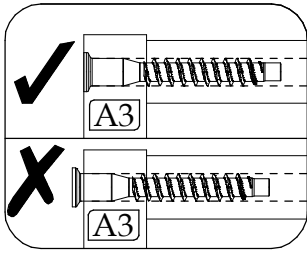

▶ 5

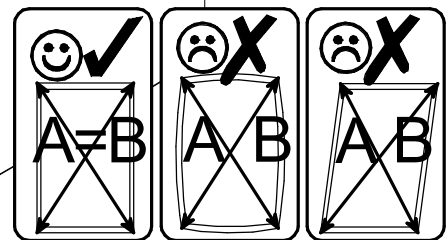
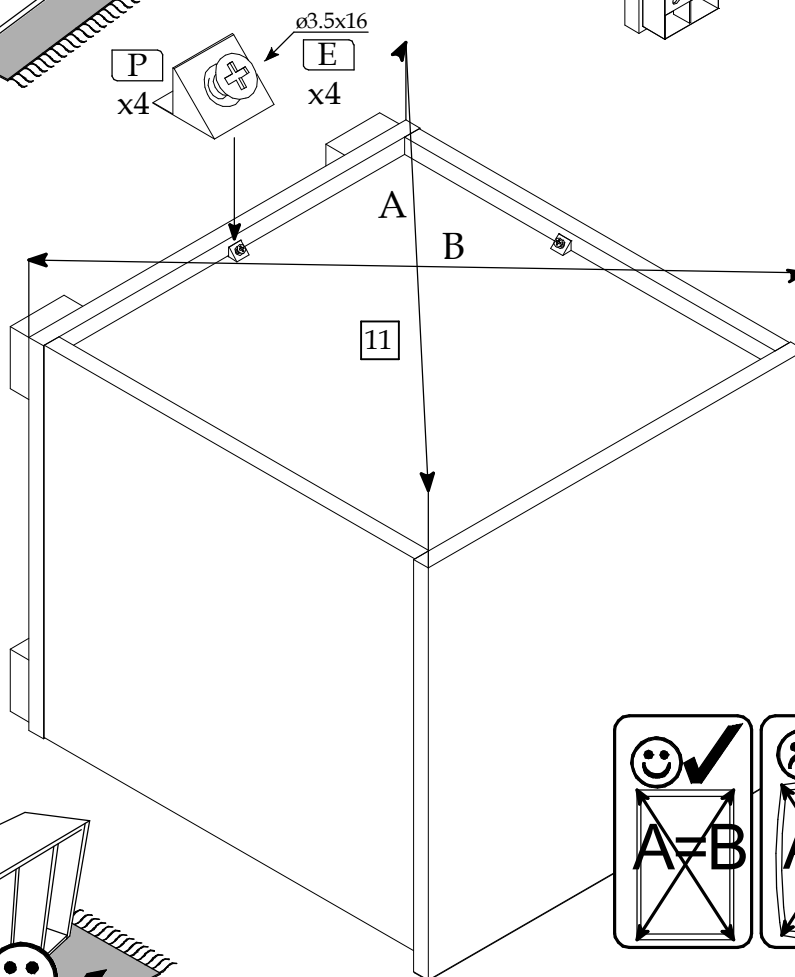

▶ 6

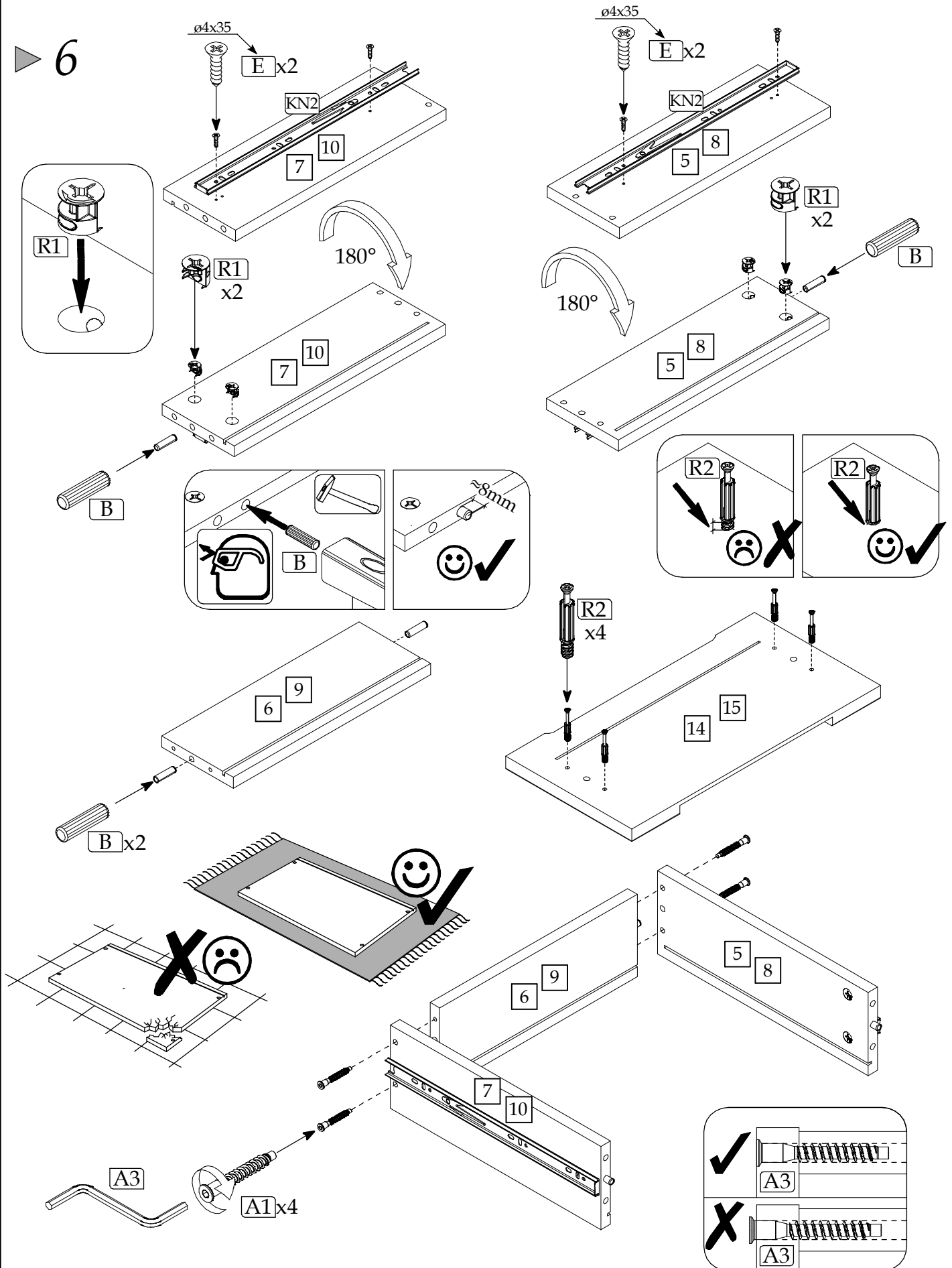

▶ 8

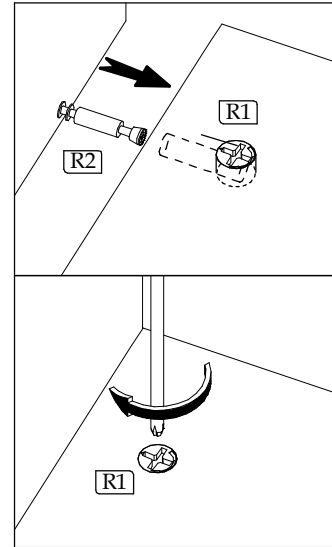
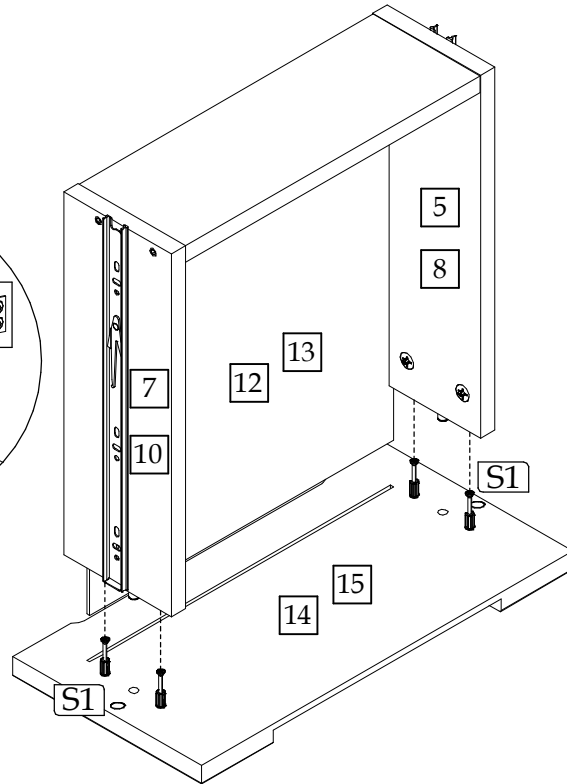
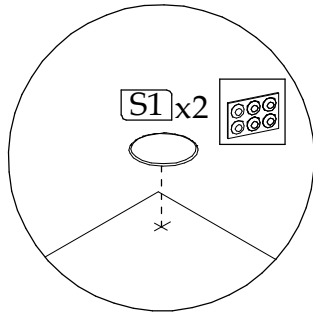

▶ 9

