

HENRY

Type A

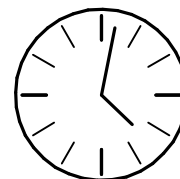

60 min

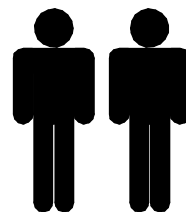
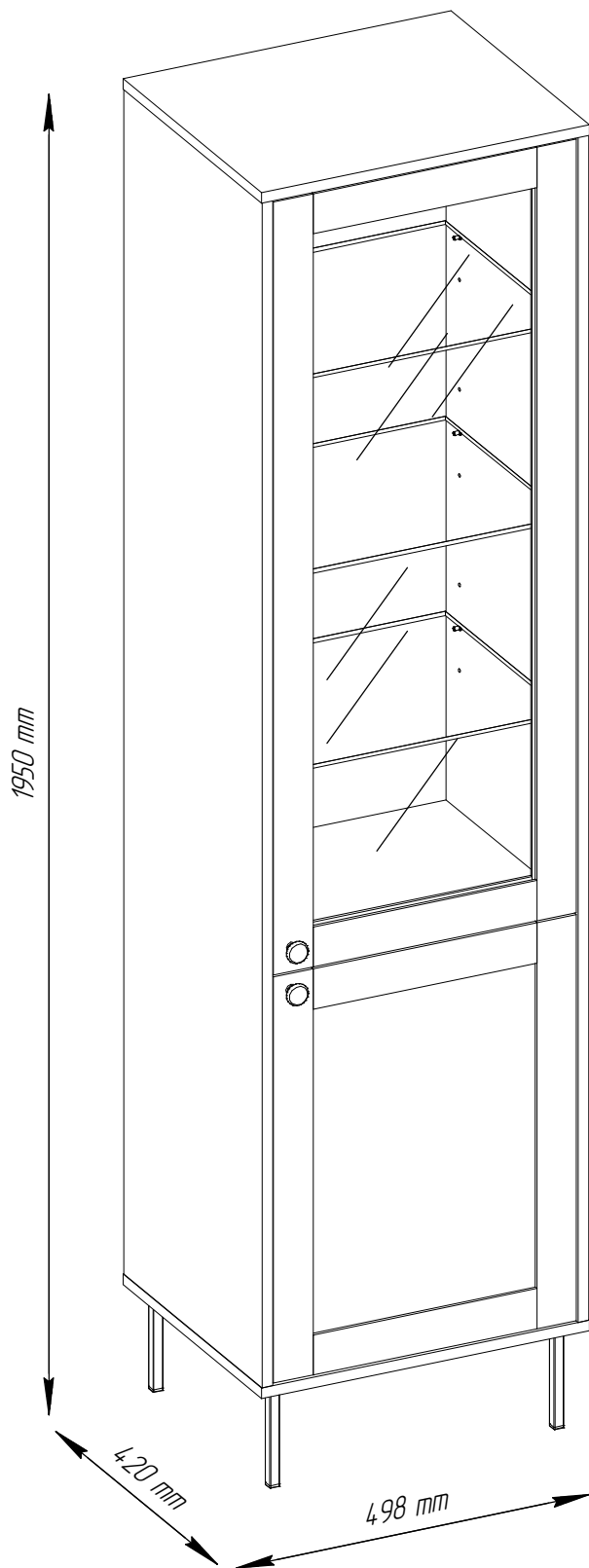
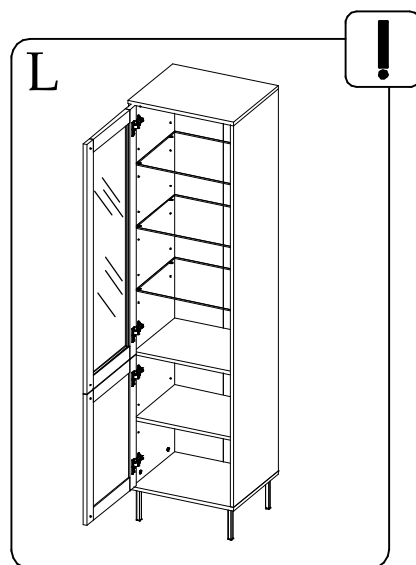
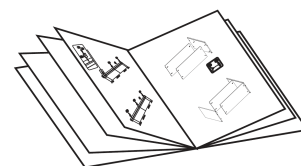
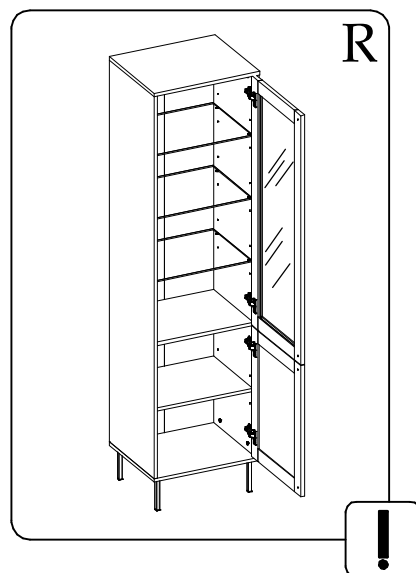

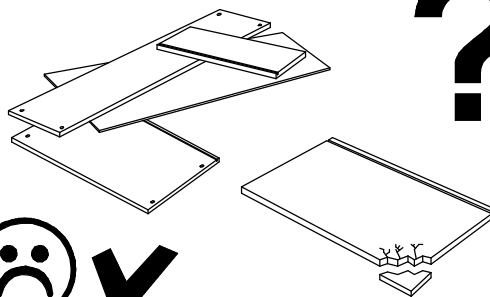
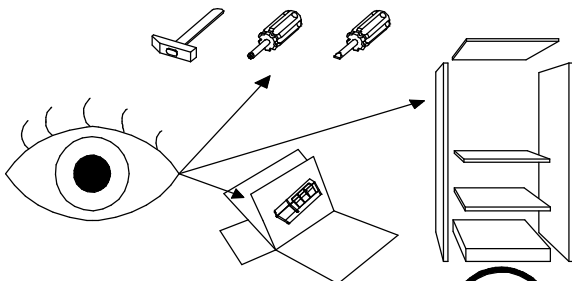
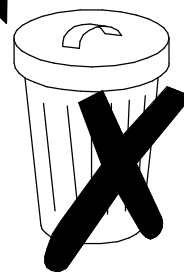
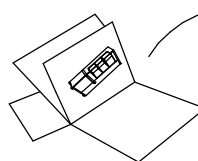
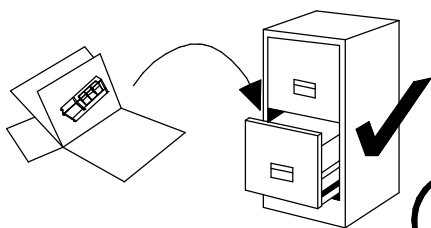
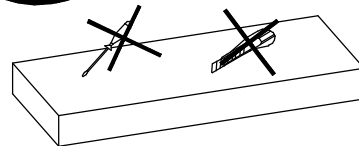
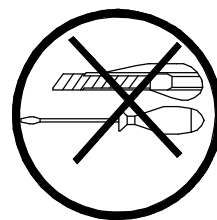
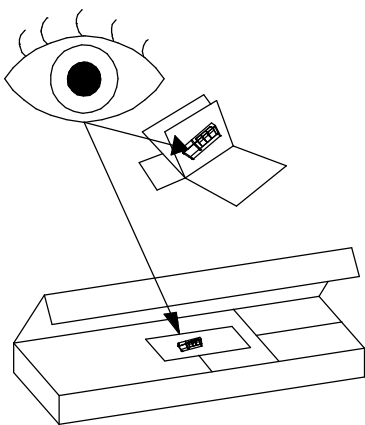

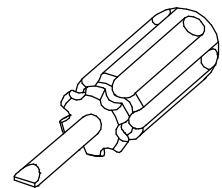
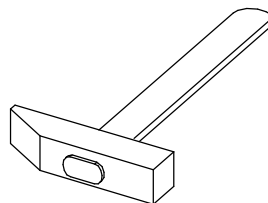
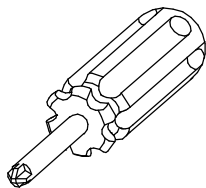
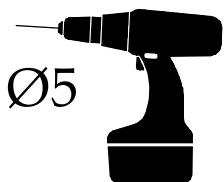
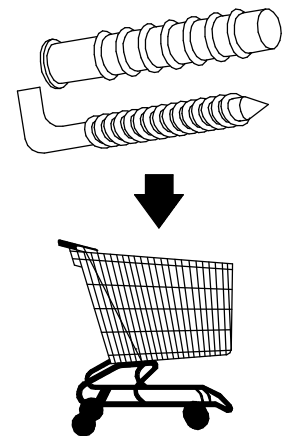
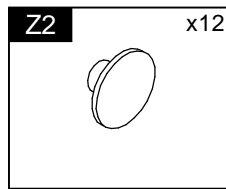
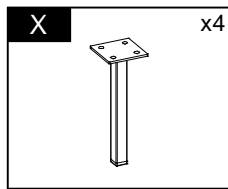
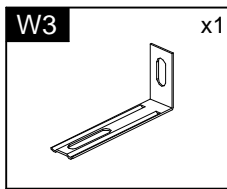
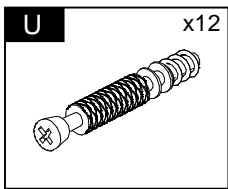
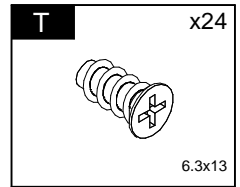
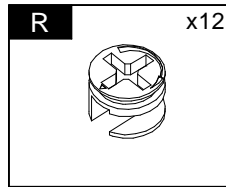
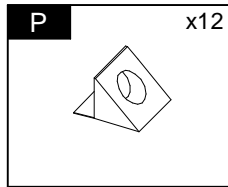
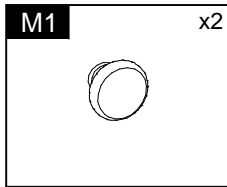
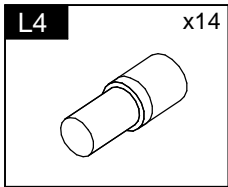
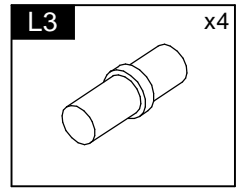
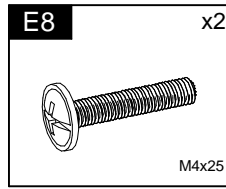
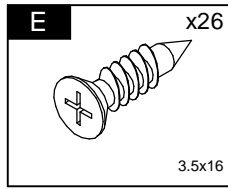
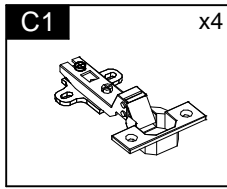
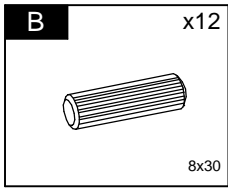
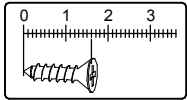
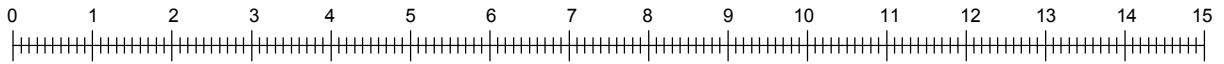

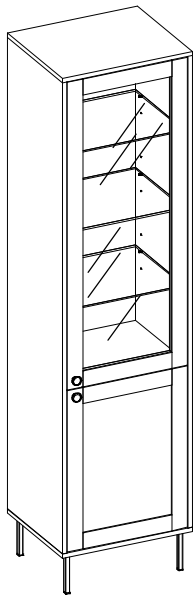

Element symbol	Measurements				Code	Pack
	1	2	3	4		
1	1768	419.5	16	1	1002	1/3
2	1768	419.5	16	1	1003	1/3
3	498	420	16	1	1004	1/3
4	498	420	16	1	1005	1/3
5	464	379	16	1	1007	1/3
6	463	370	16	1	N/A	1/3
7	1782	239	3	2	N/A	1/3
8	606	460	19	1	3001	2/3
9	1154	460	19	1	3002	2/3
10	463	370	6	3	Glass	3/3

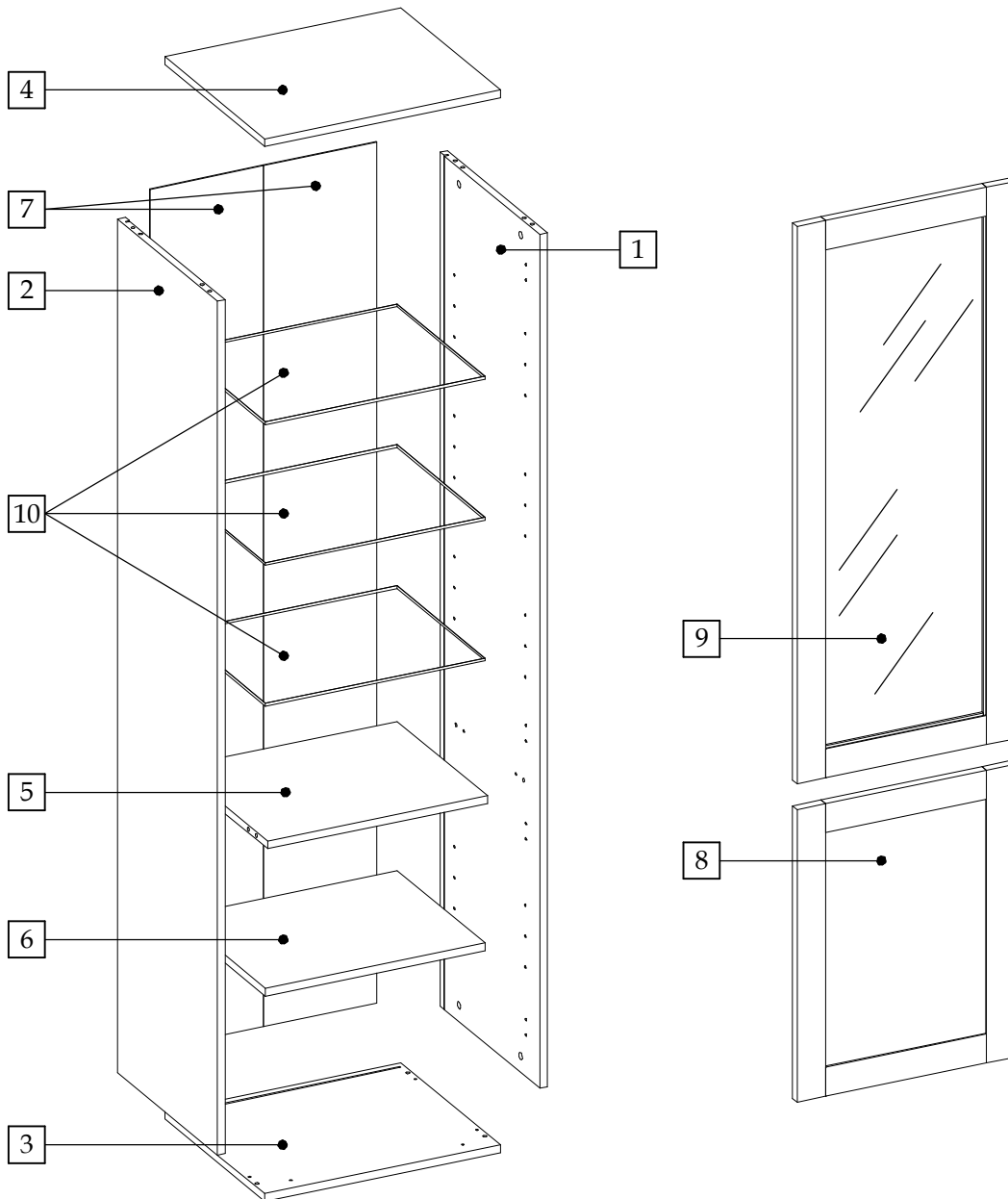

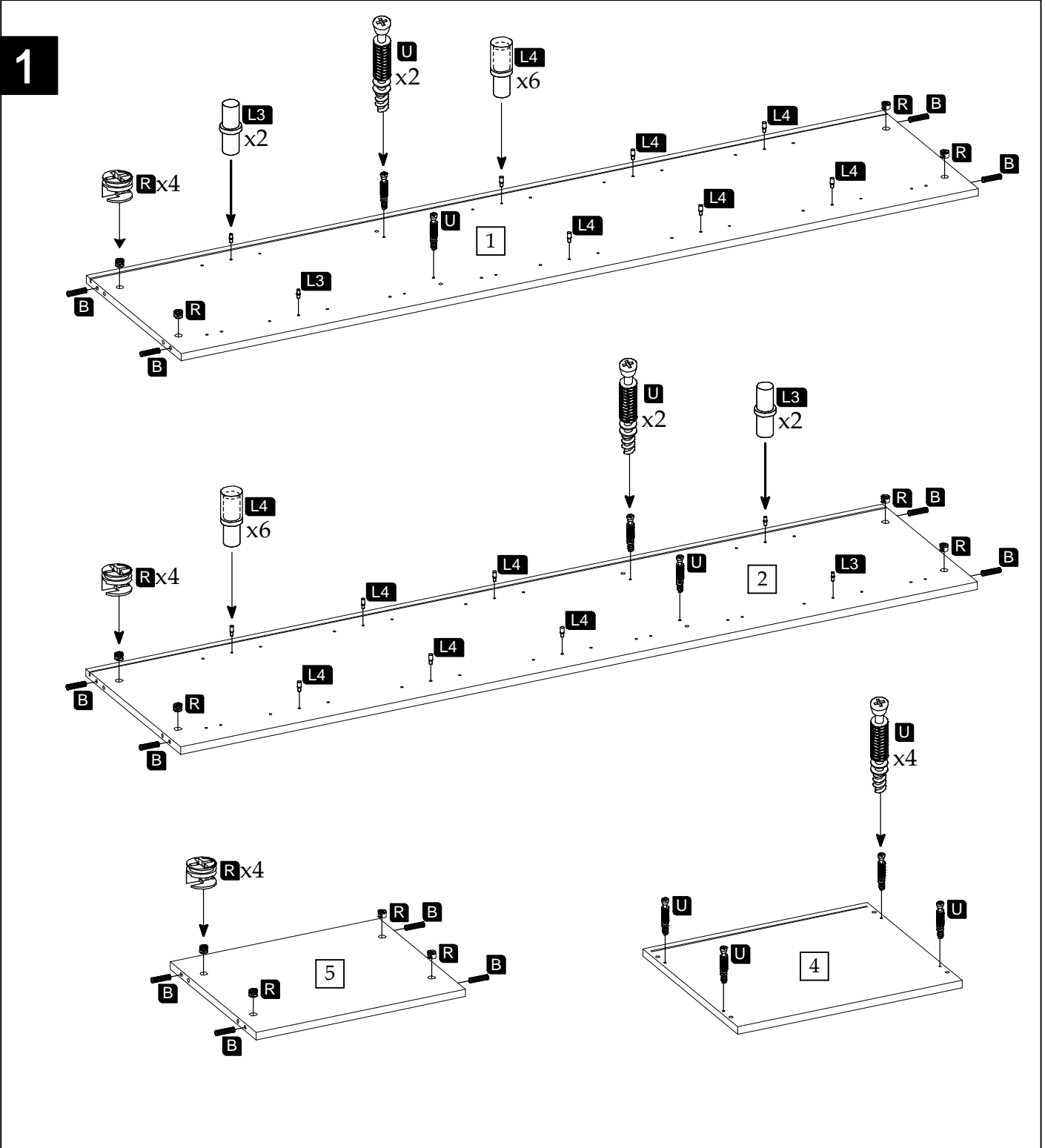
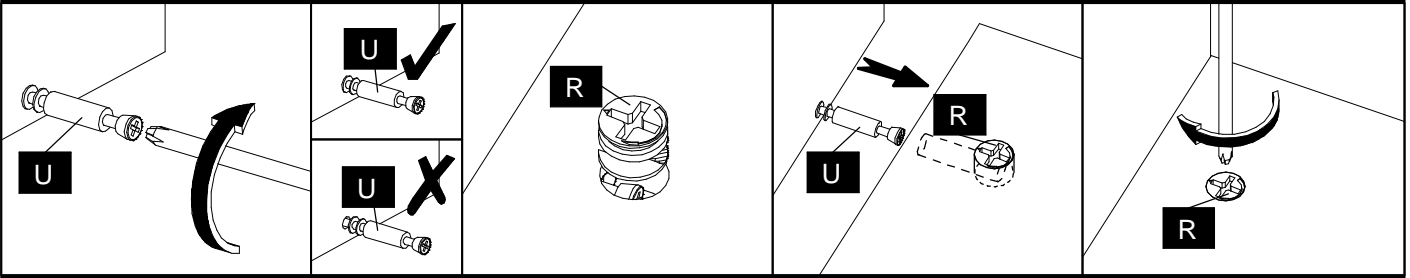

2

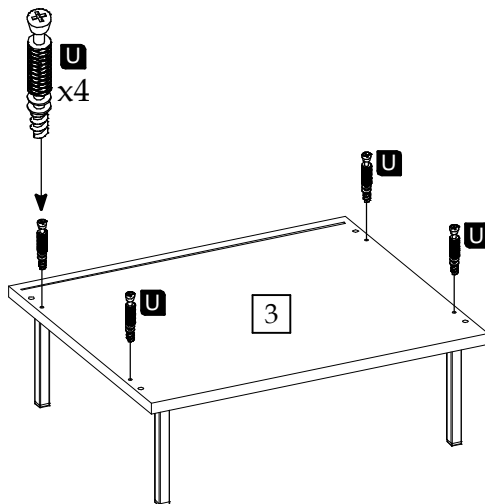
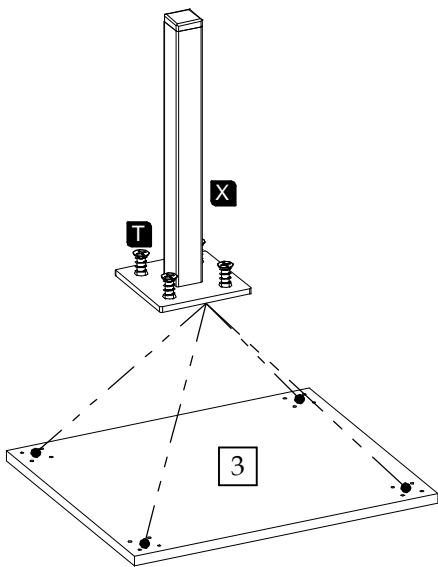

3

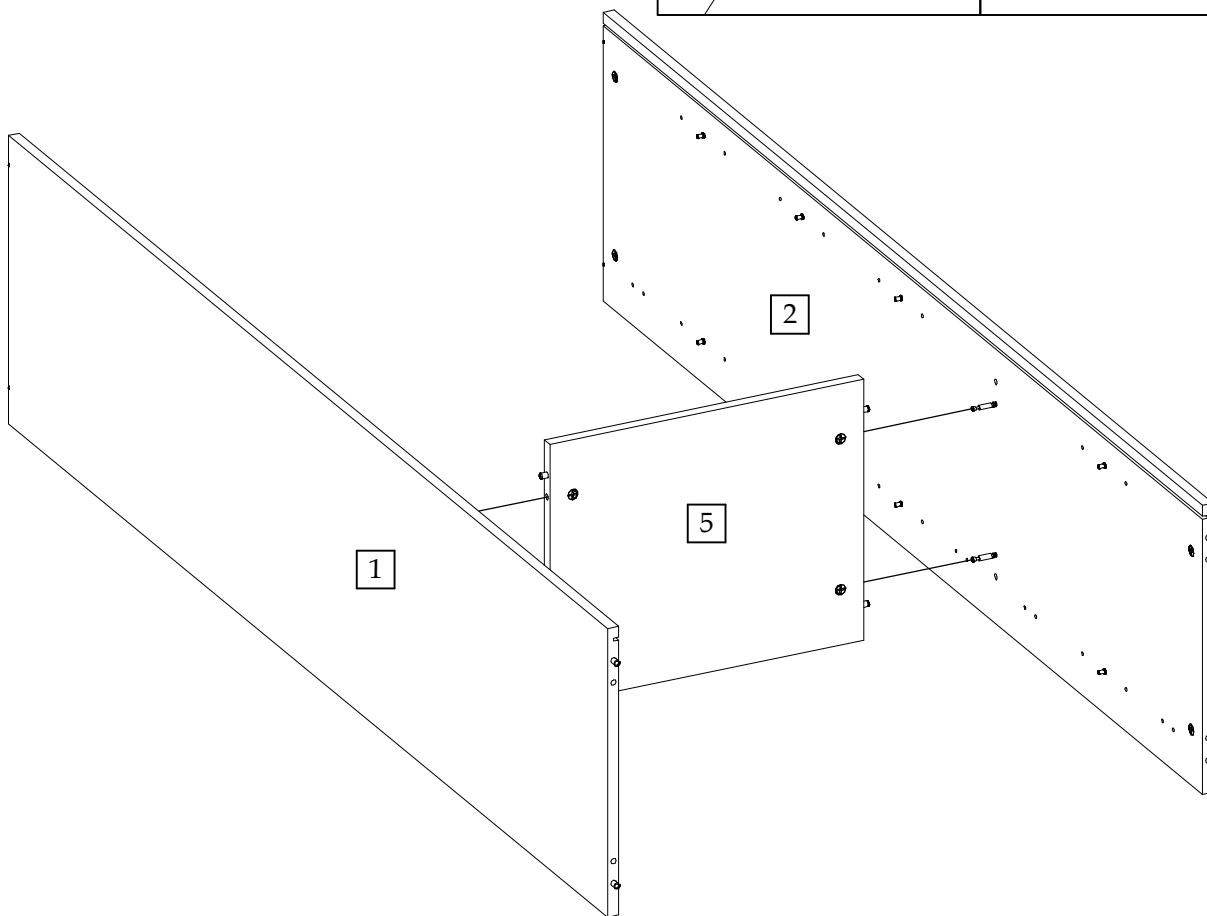
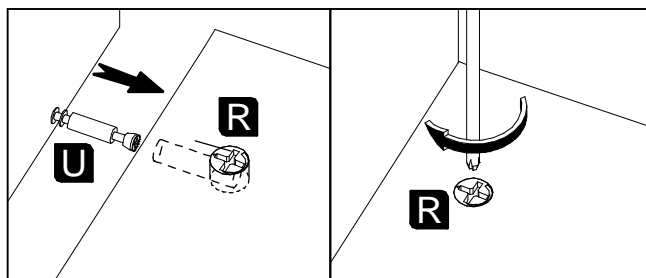

4

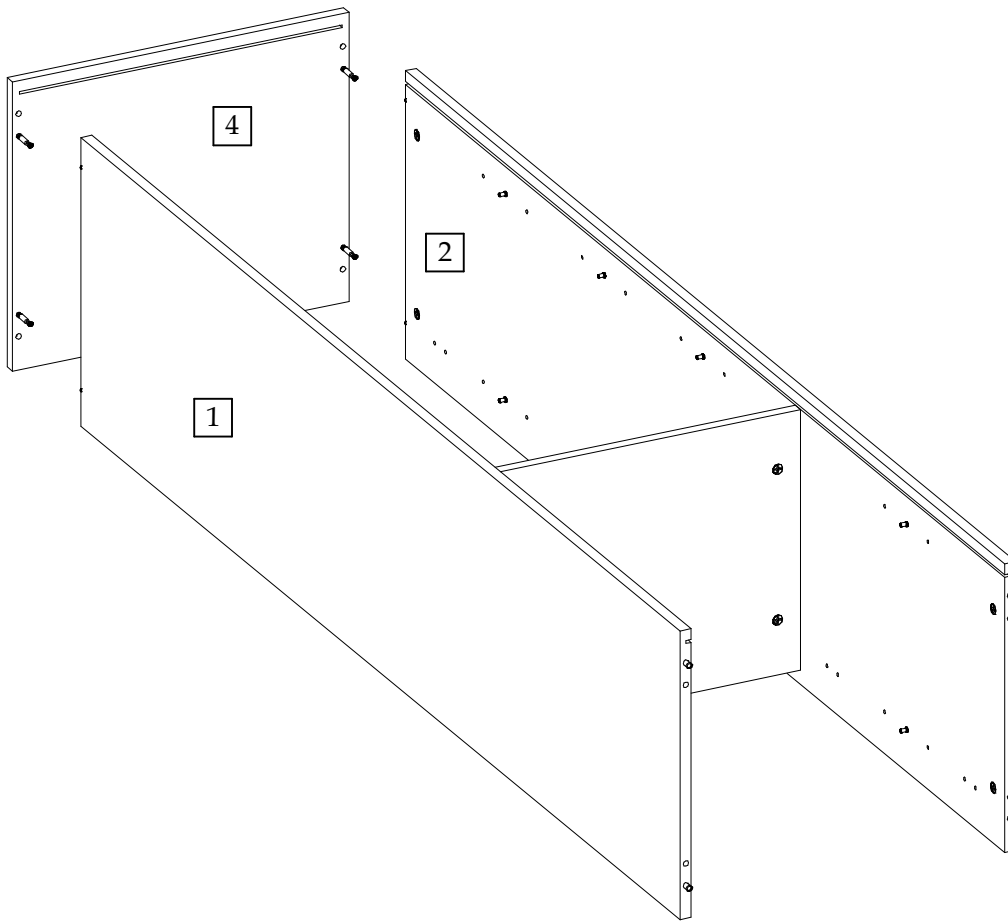

5

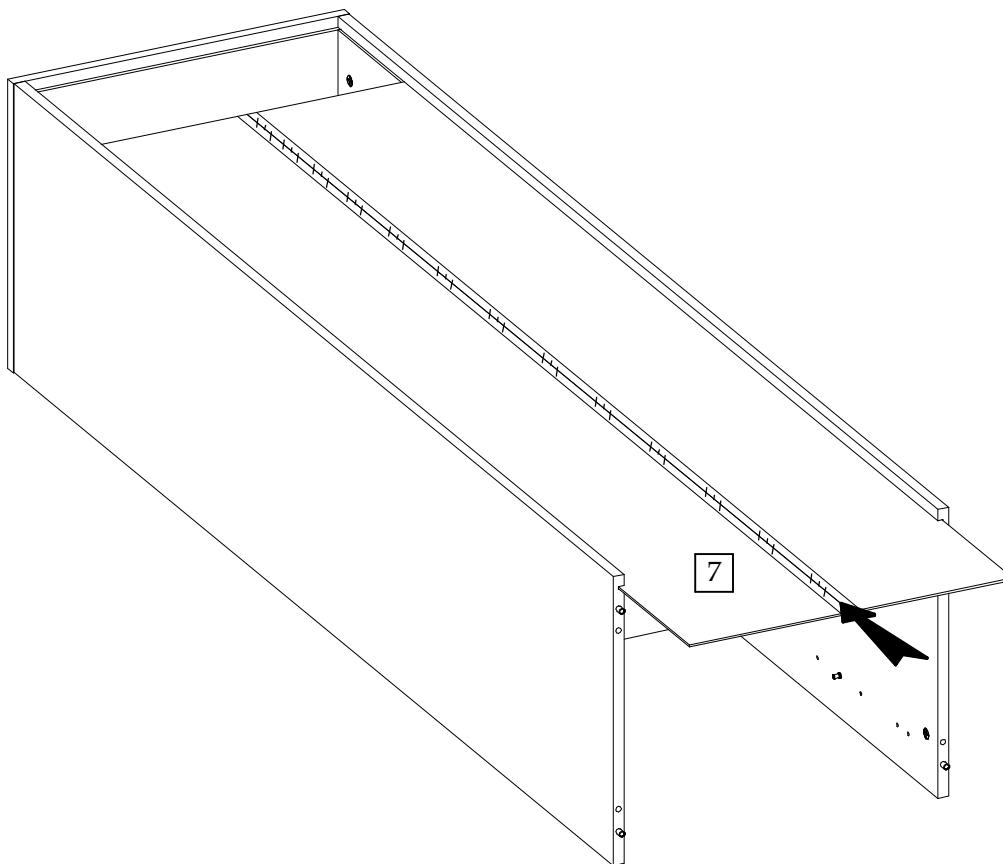

6

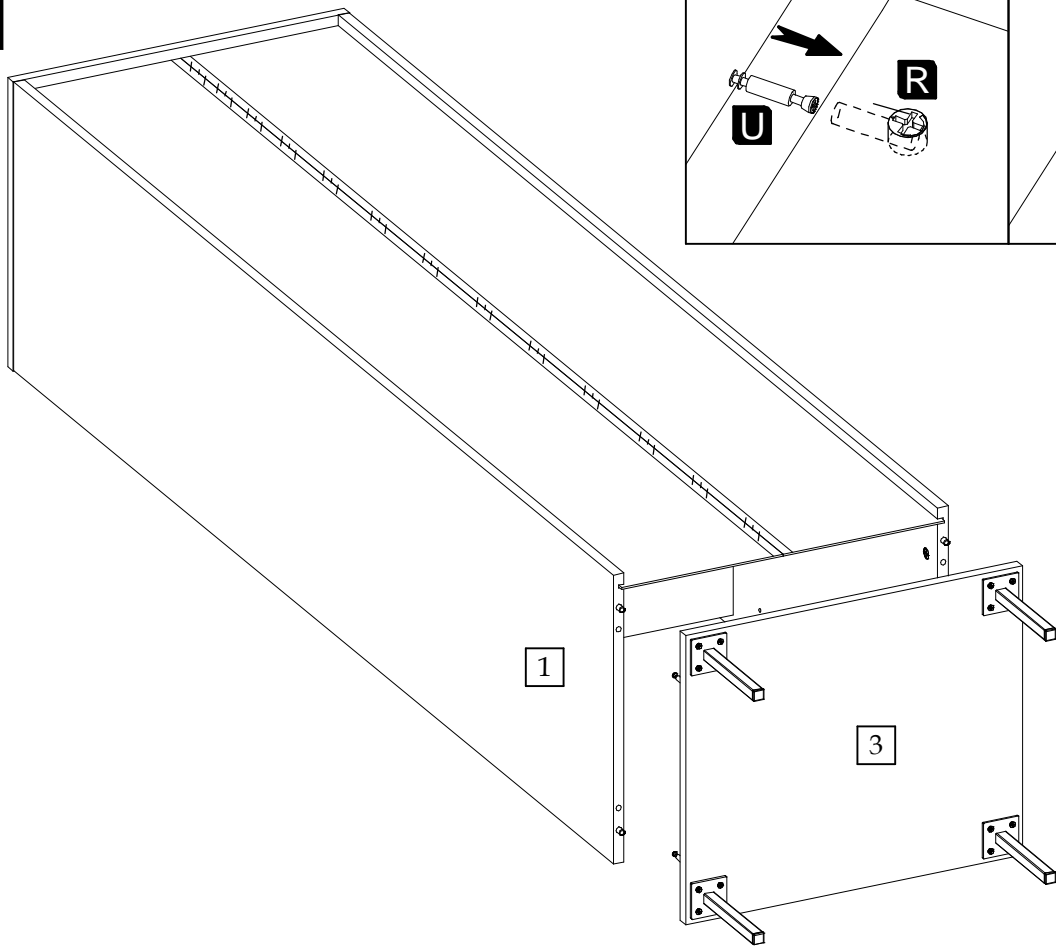

7

