

HENRY

Type B

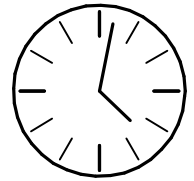

60 min

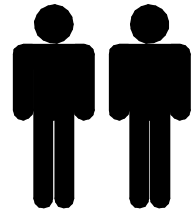
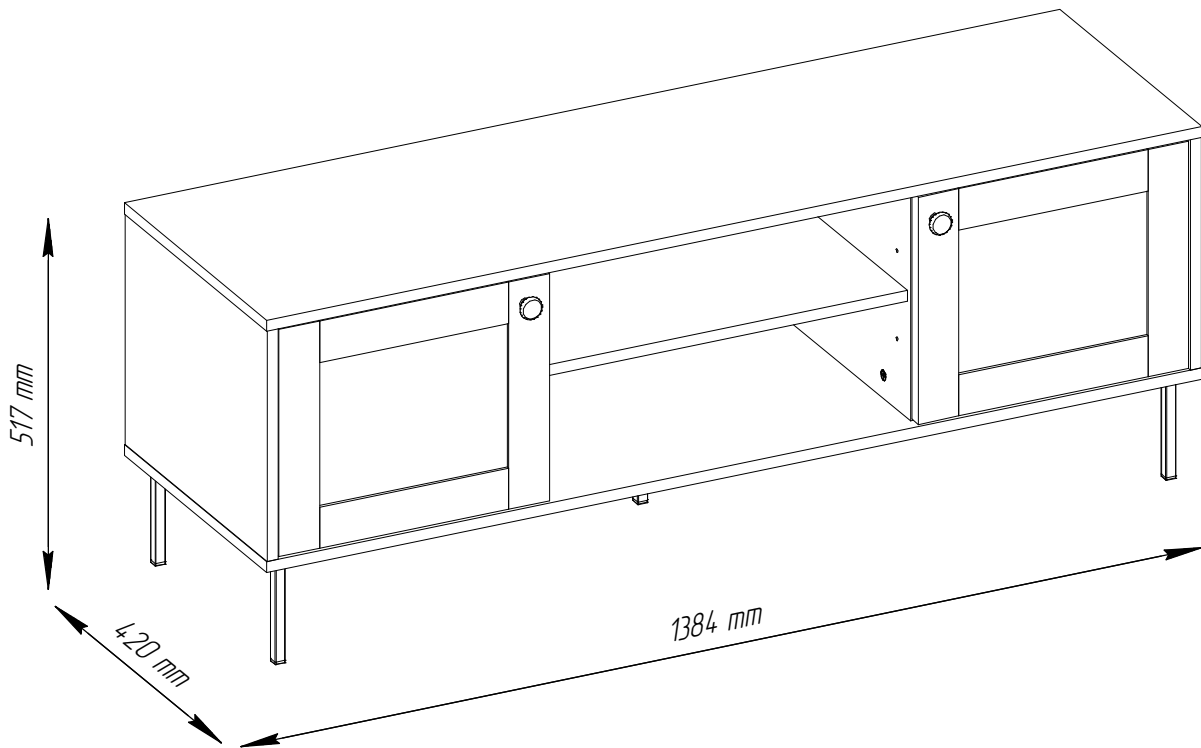

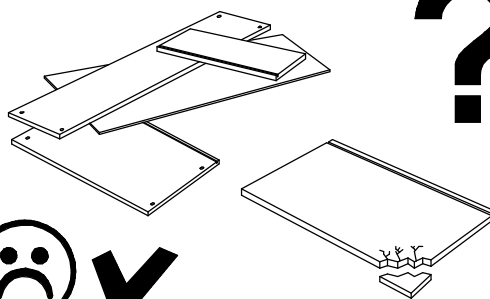
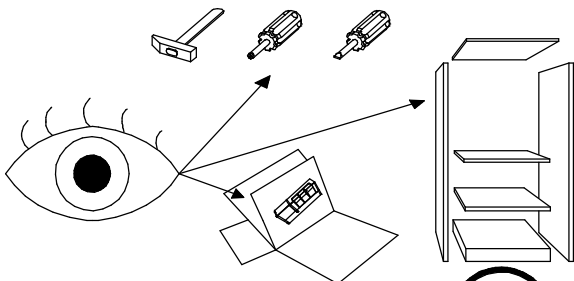
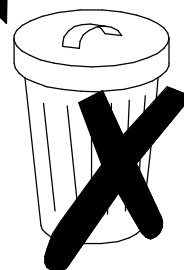
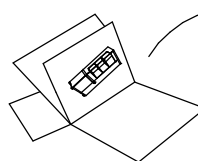
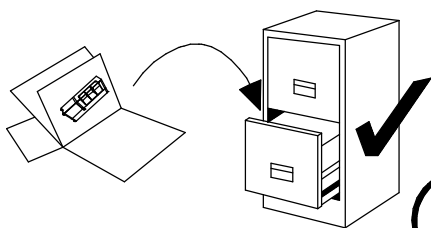
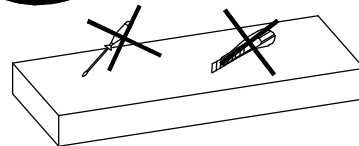
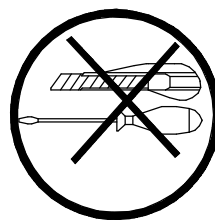
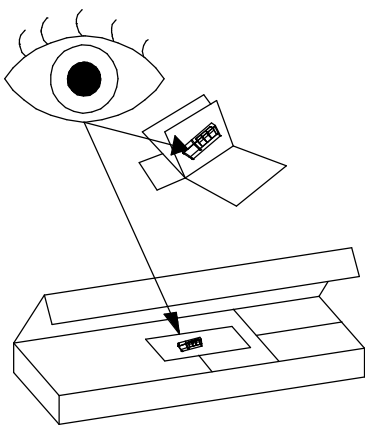

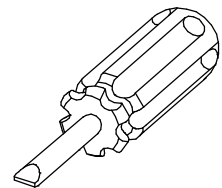
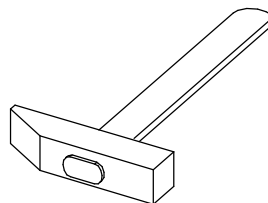
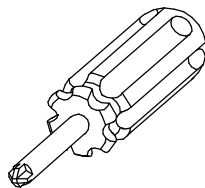
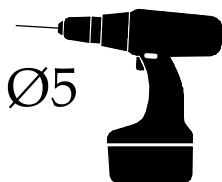
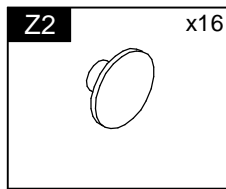
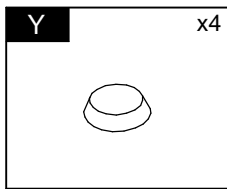
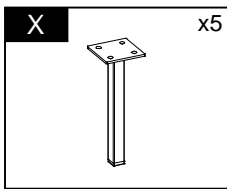
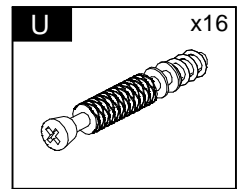
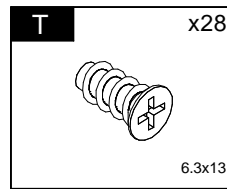
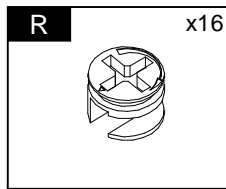
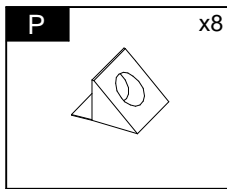
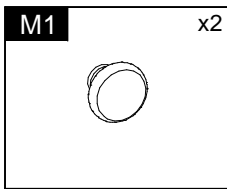
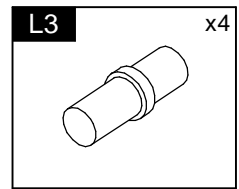
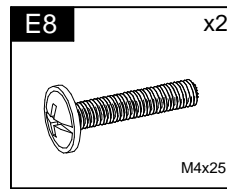
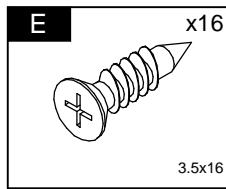
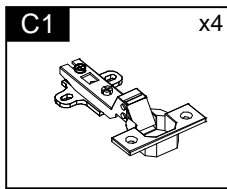
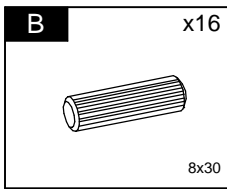
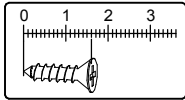
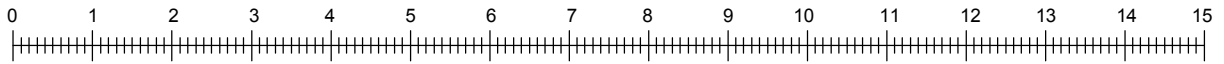

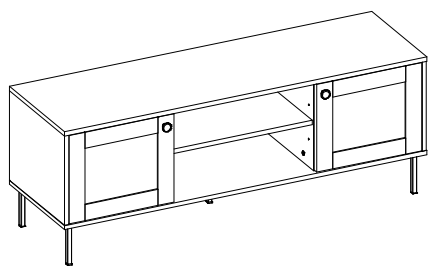

Element symbol	Measurements				Code	Pack
1	335	419.5	16	2	1002	1/1
2	1384	420	16	1	1004	1/1
3	1384	420	16	1	1005	1/1
4	335	378.5	16	2	1007	1/1
5	541	370	16	1	N/A	1/1
6	1364	349	3	1	1009	1/1
7	330	400	19	2	3001	1/1

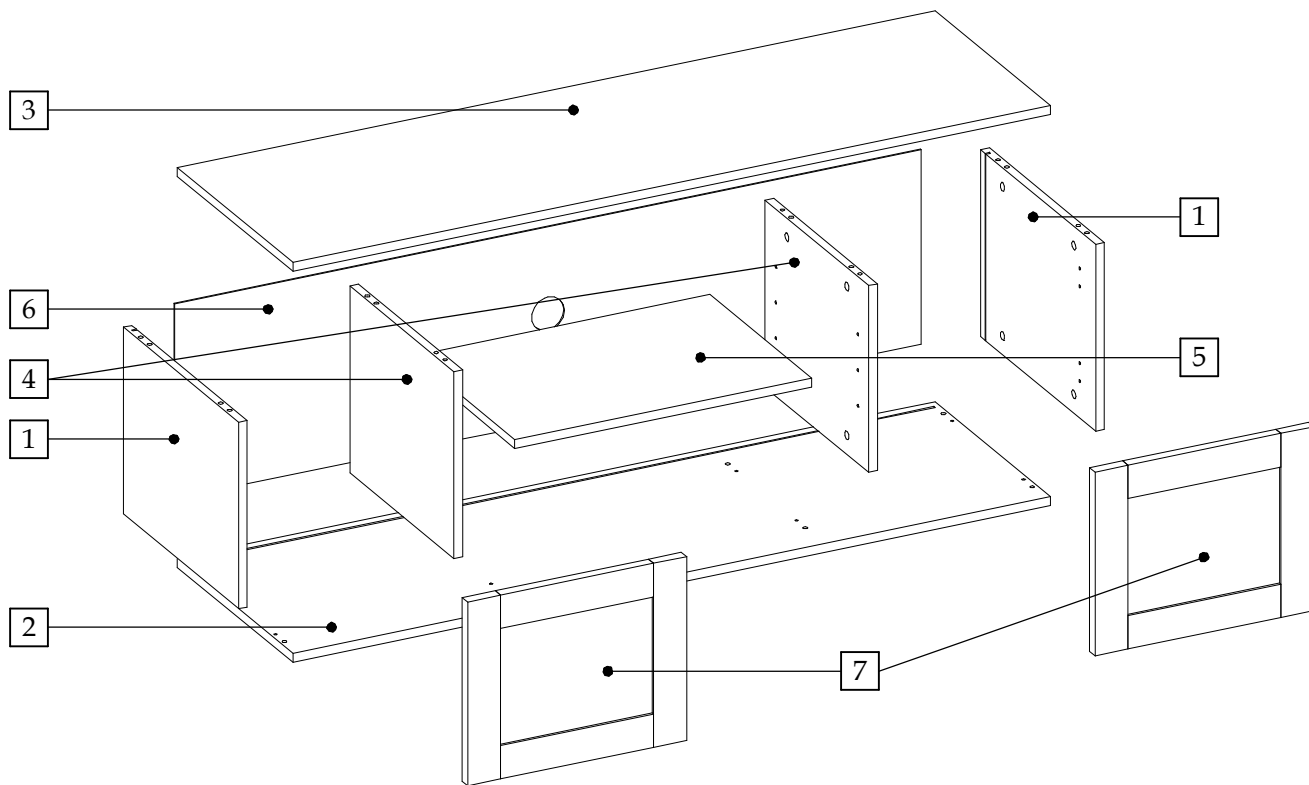

2

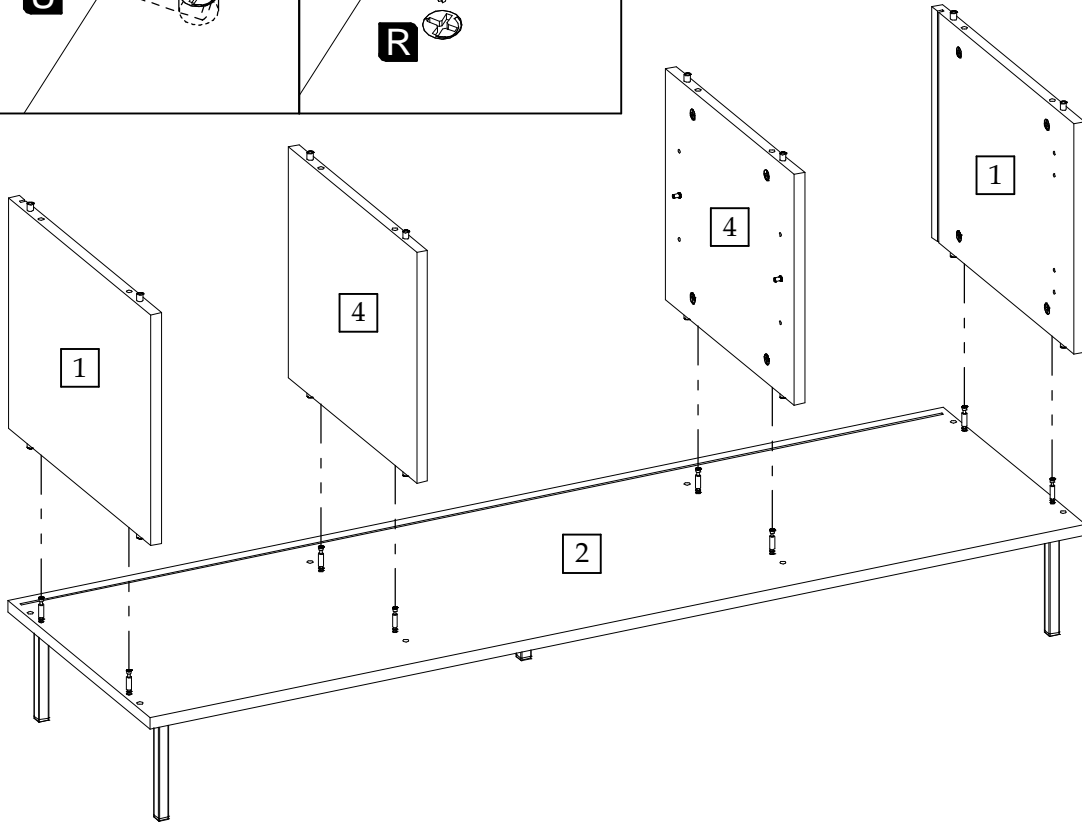
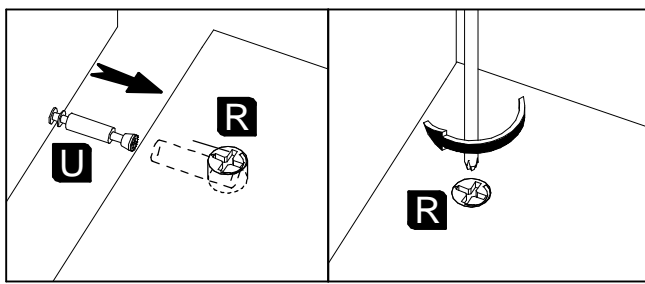

3

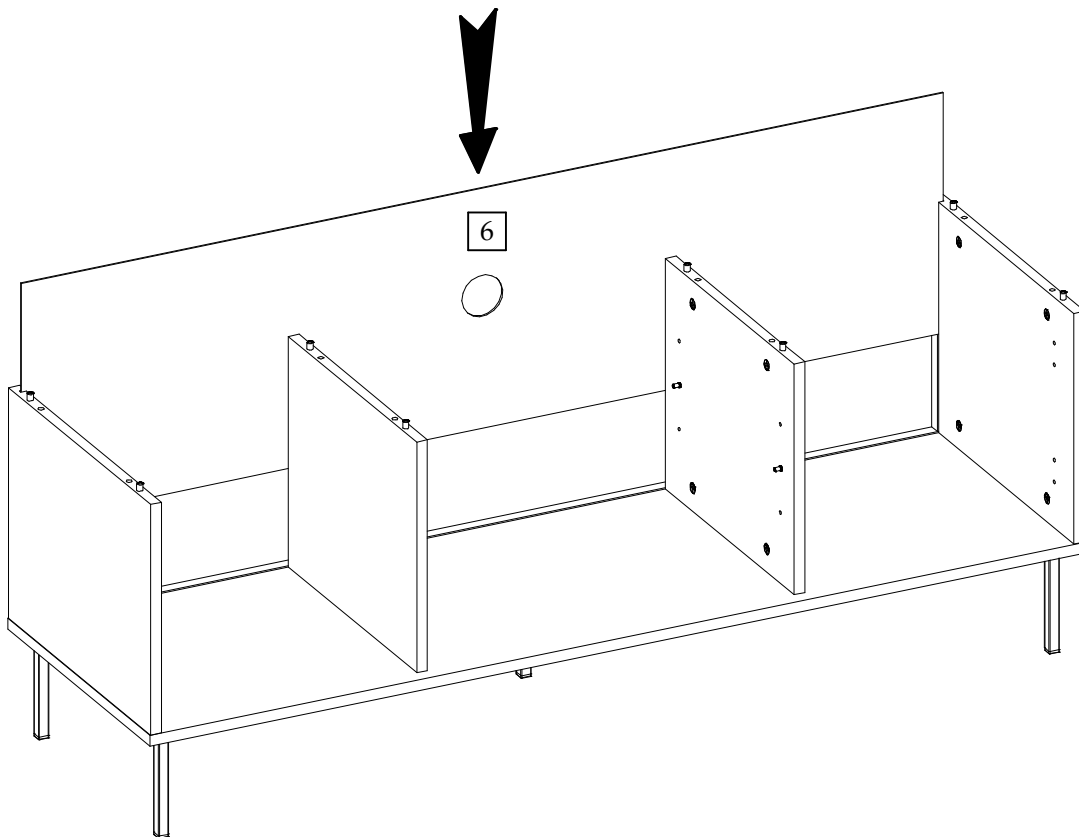

4

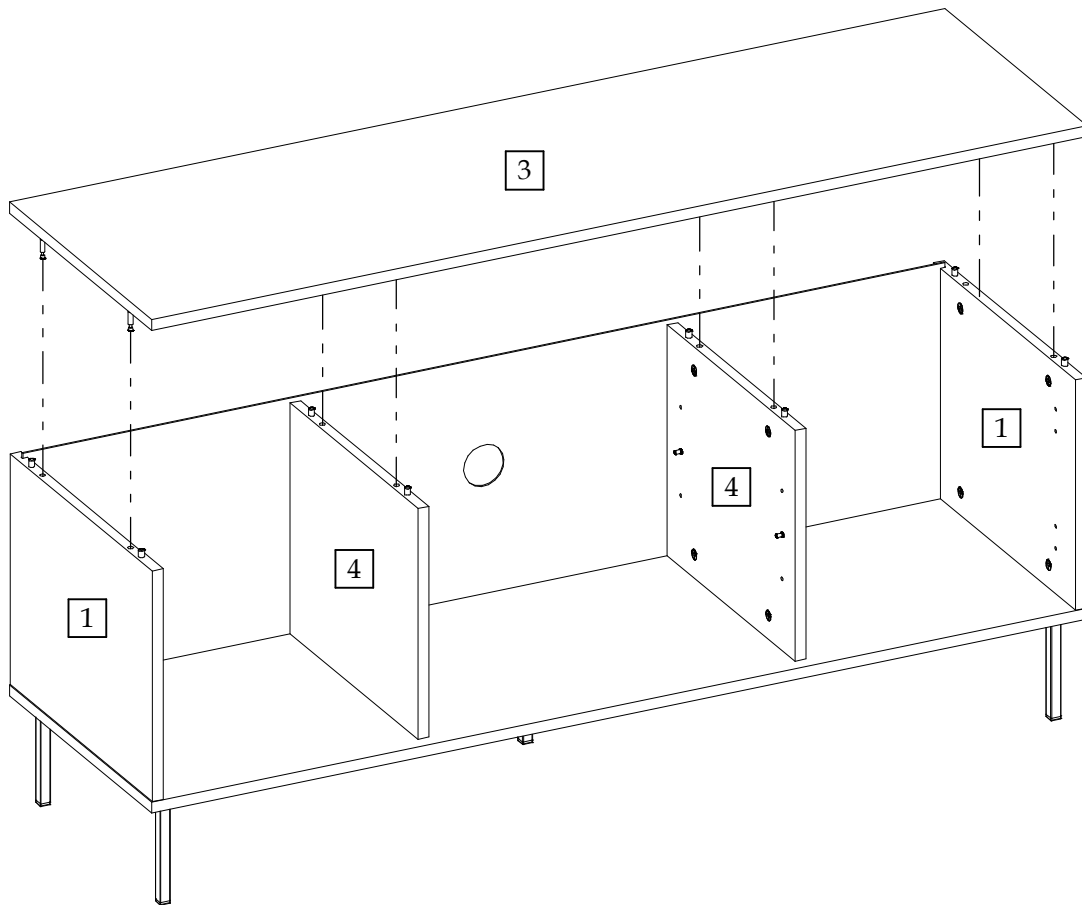

5

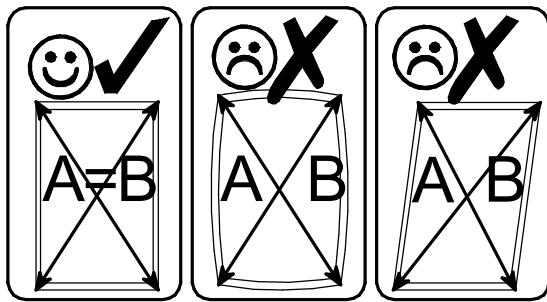

ø3.5x16

