

# HENRY

## Type C

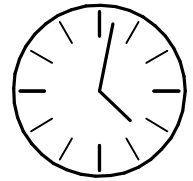

70 min

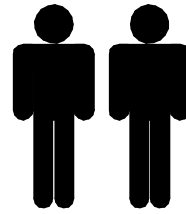

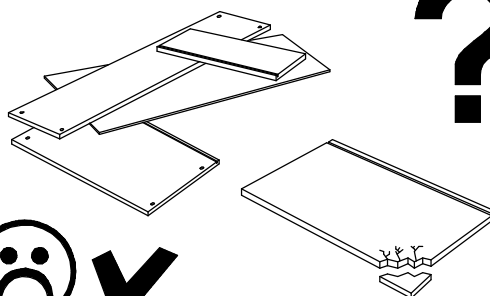
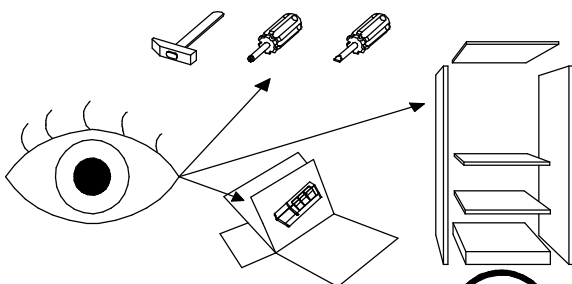
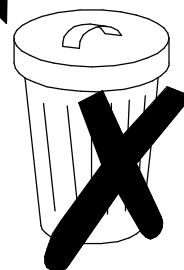
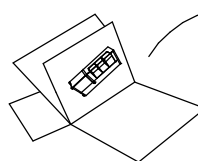
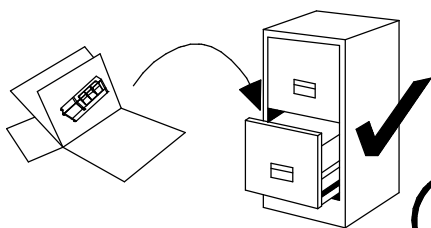
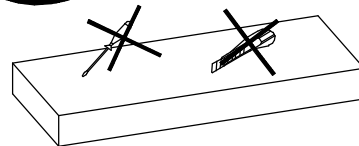
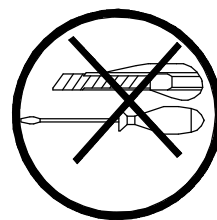
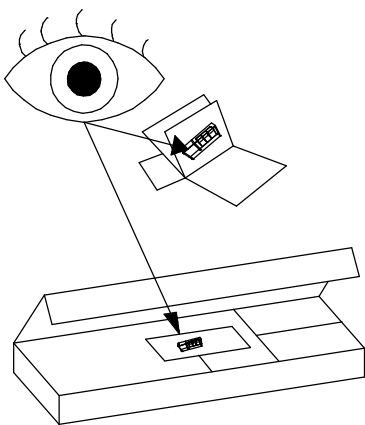

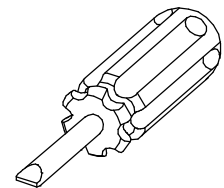
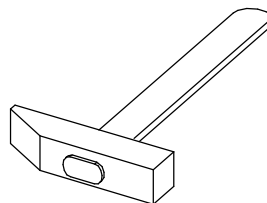
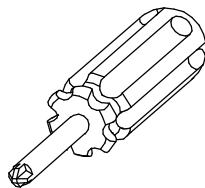
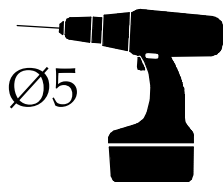
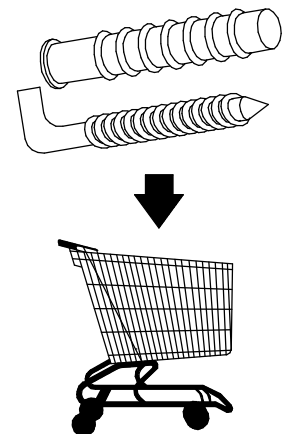
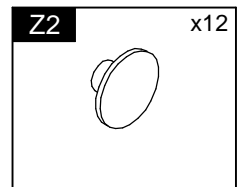
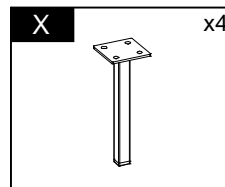
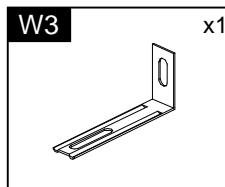
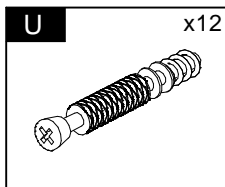
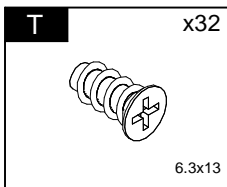
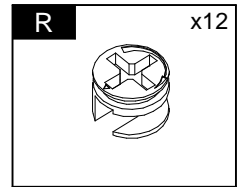
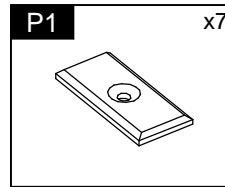
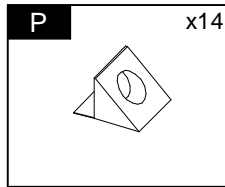
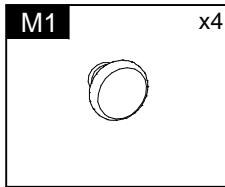
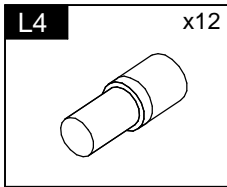
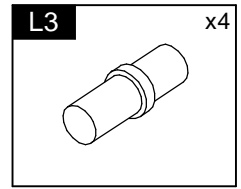
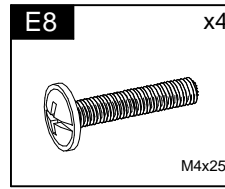
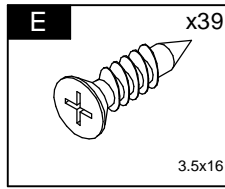
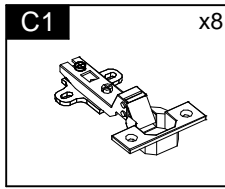
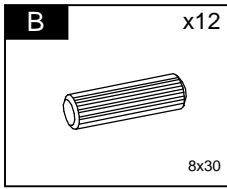
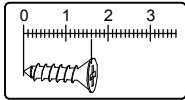

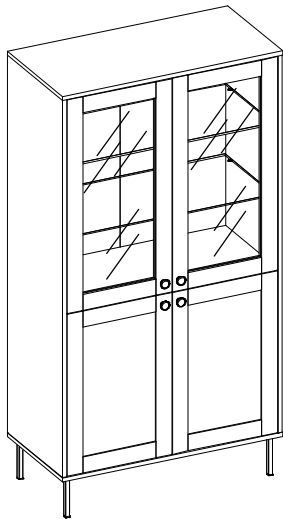

Element symbol	Measurements				Code	Pack
	1	2	3	4		
1	1414	419.5	16	1	1002	1/3
2	1414	419.5	16	1	1003	1/3
3	841	420	16	1	1004	1/3
4	841	420	16	1	1005	1/3
5	807	379	16	1	1007	1/3
6	806	370	16	1	N/A	1/3
7	617	410	3	2	N/A	1/3
8	810	410	3	1	N/A	1/3
9	810	410	3	1	1008	1/3
10	606	400	19	2	3001	2/3
11	800	400	19	2	3002	2/3
12	805	370	6	2	Glass	3/3

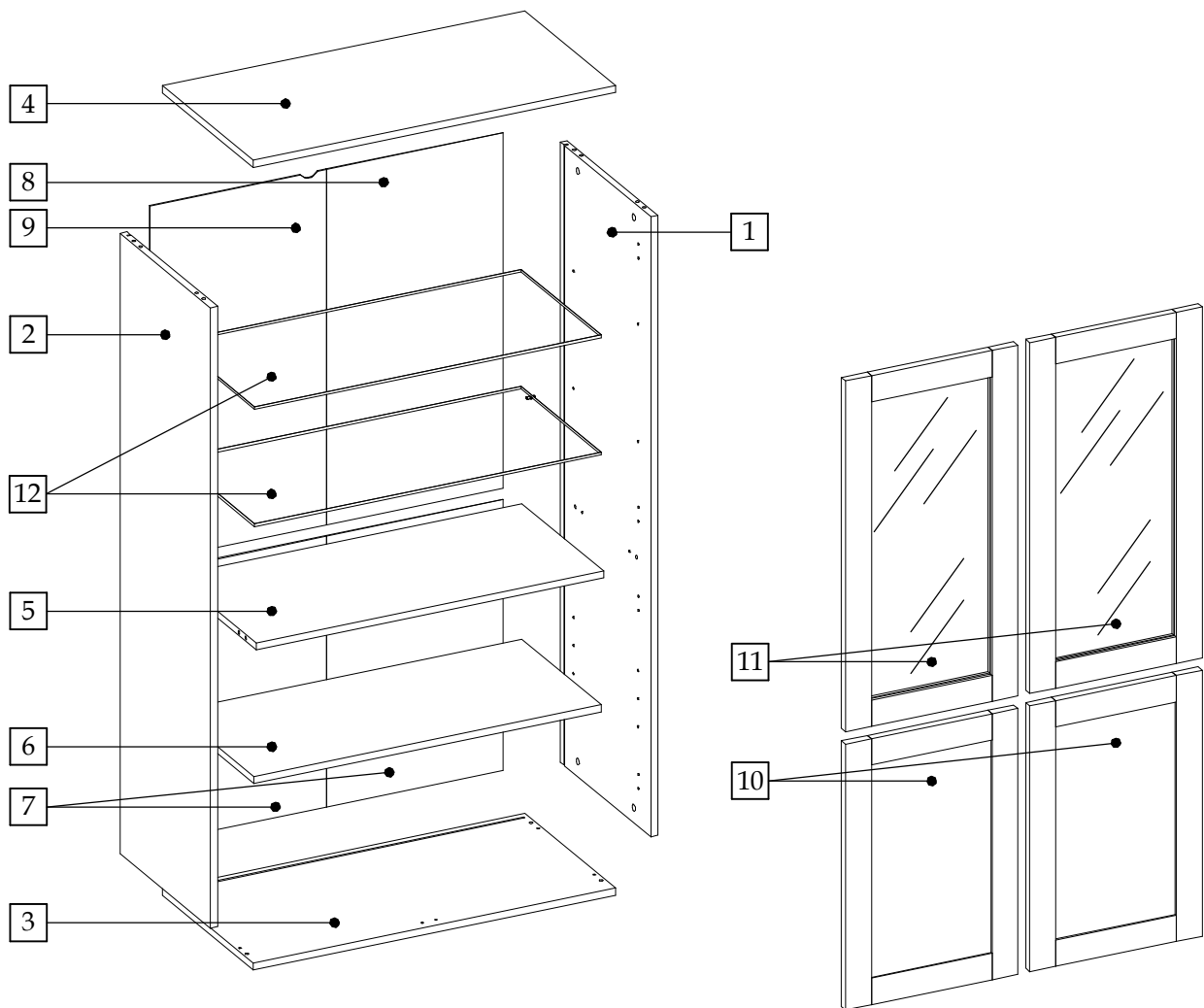

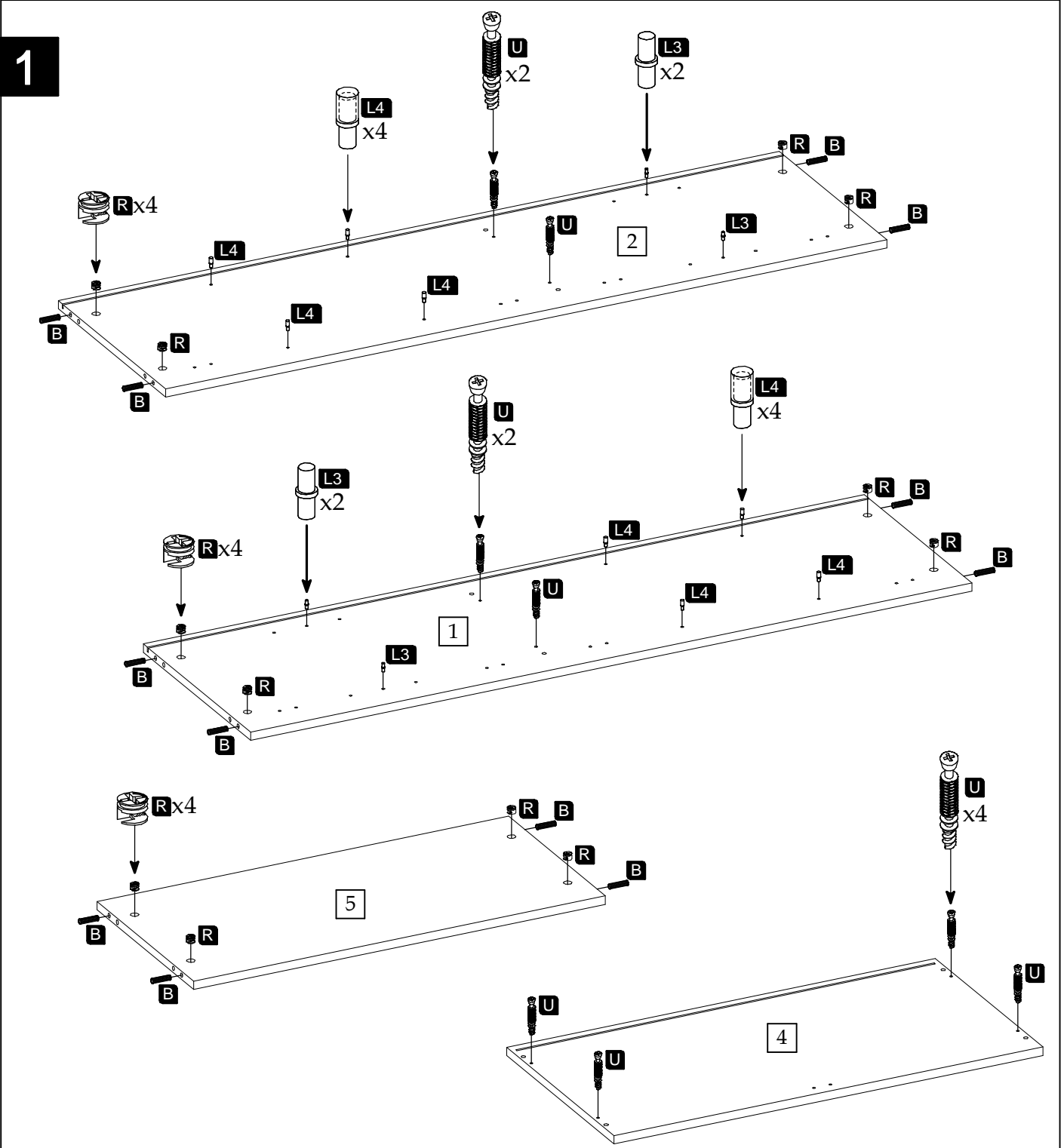

2

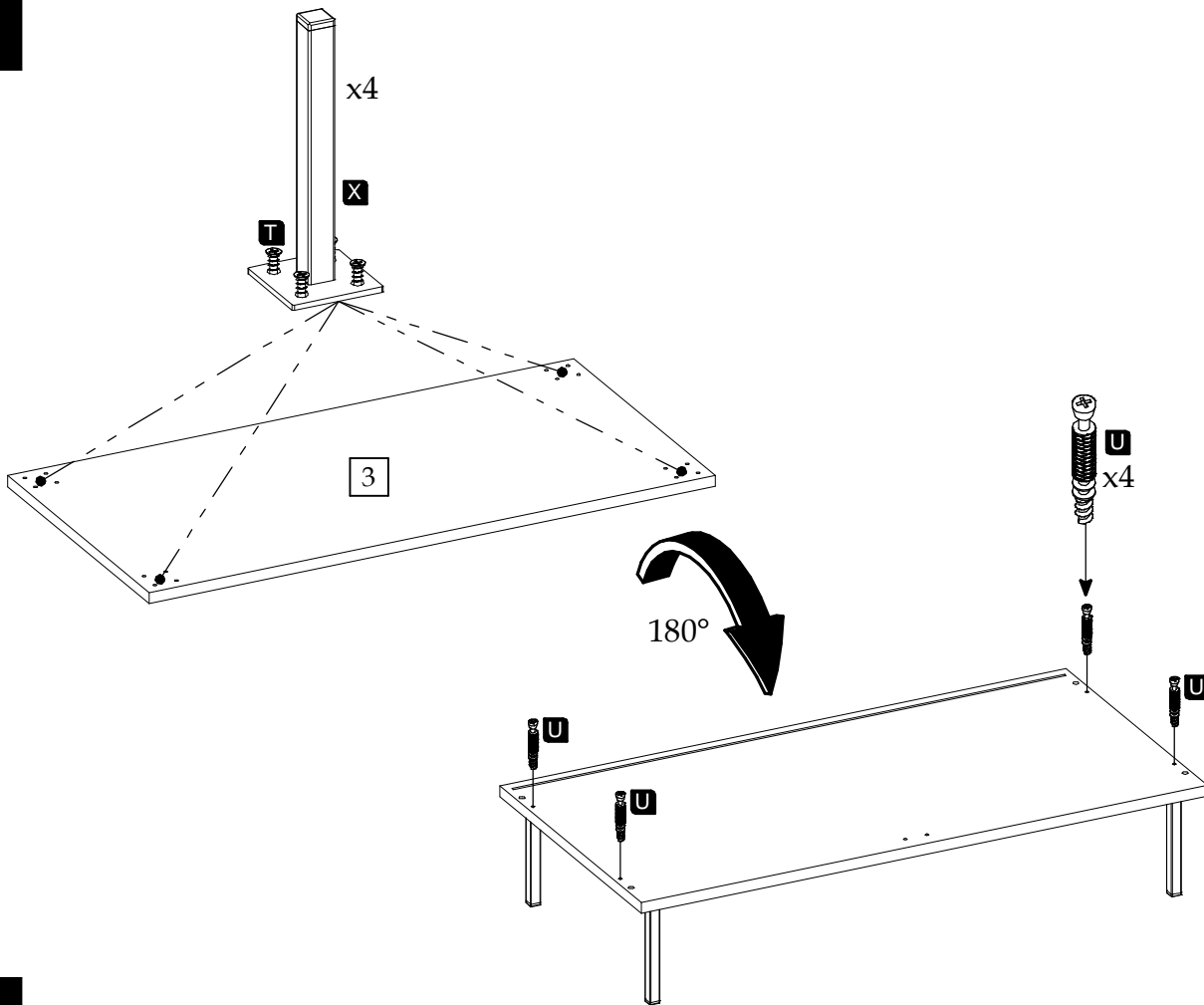

3

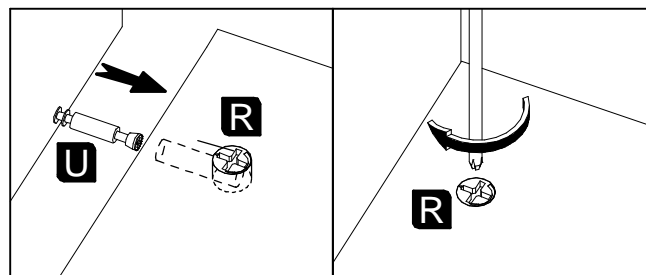
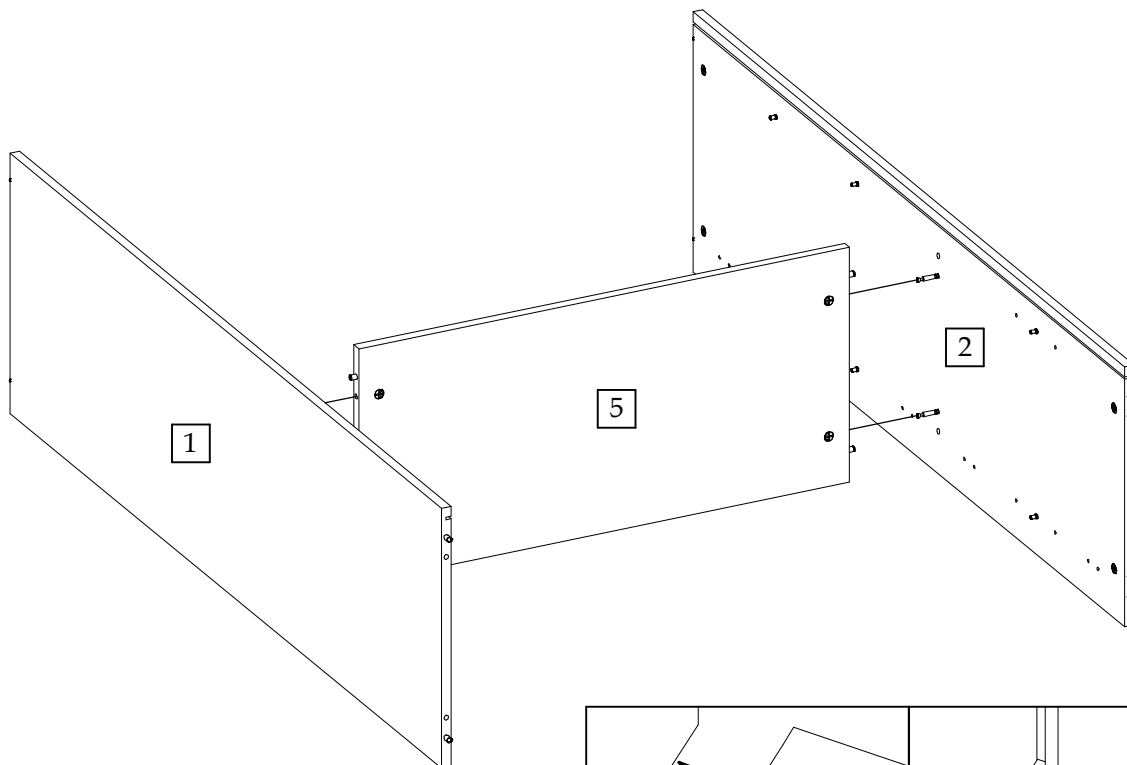

4

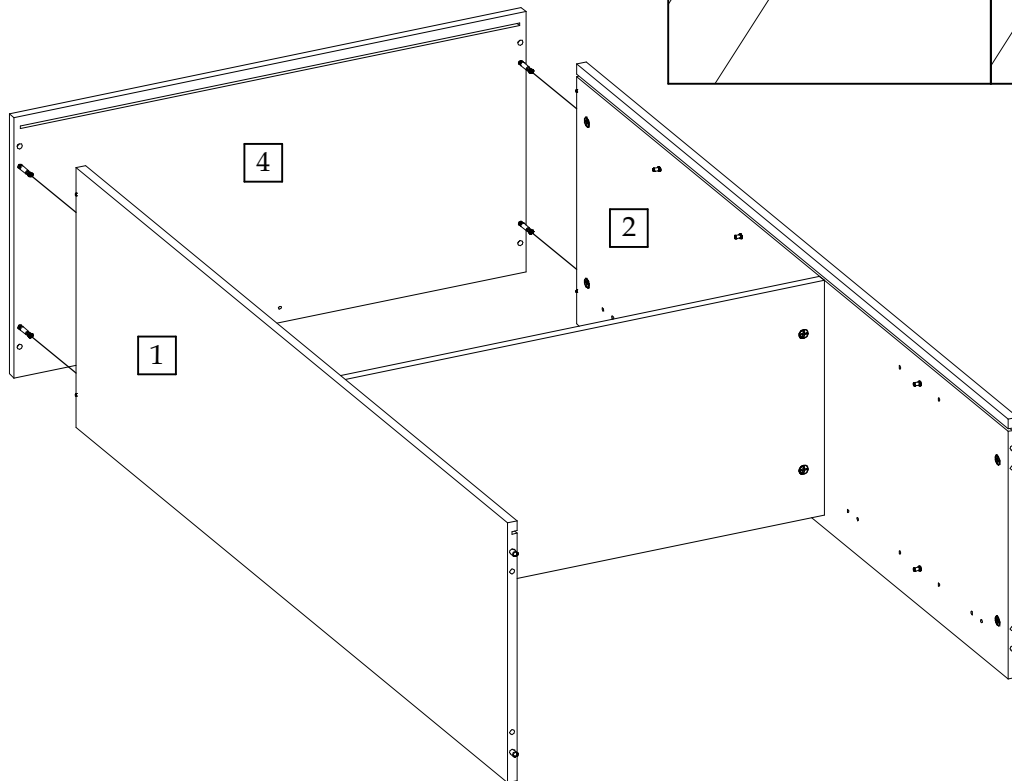

5

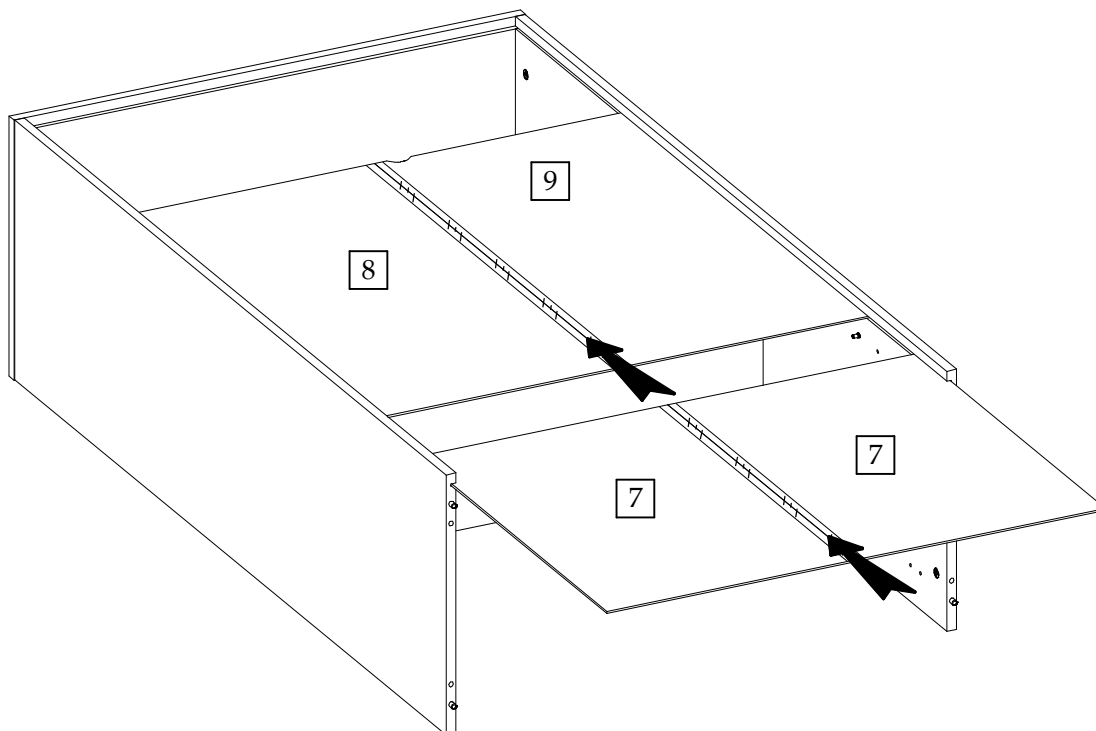

6

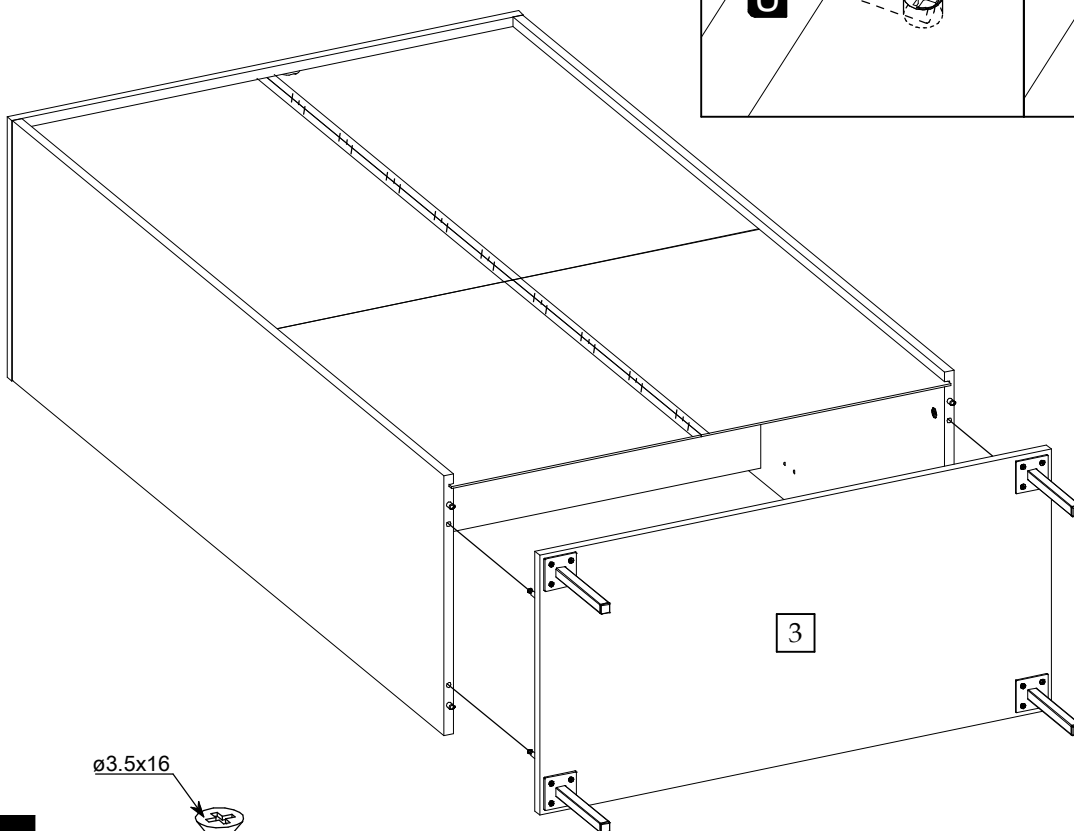
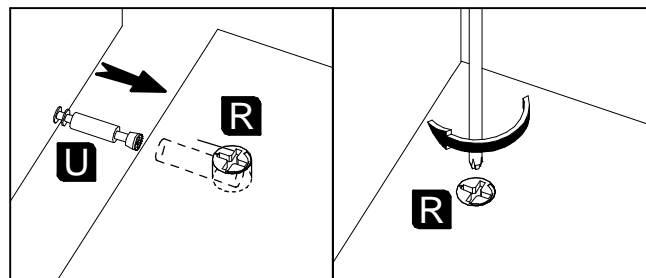

7

