

# HENRY

## Type E

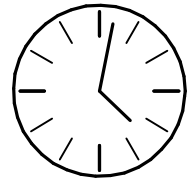

80 min

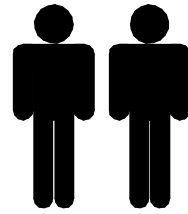
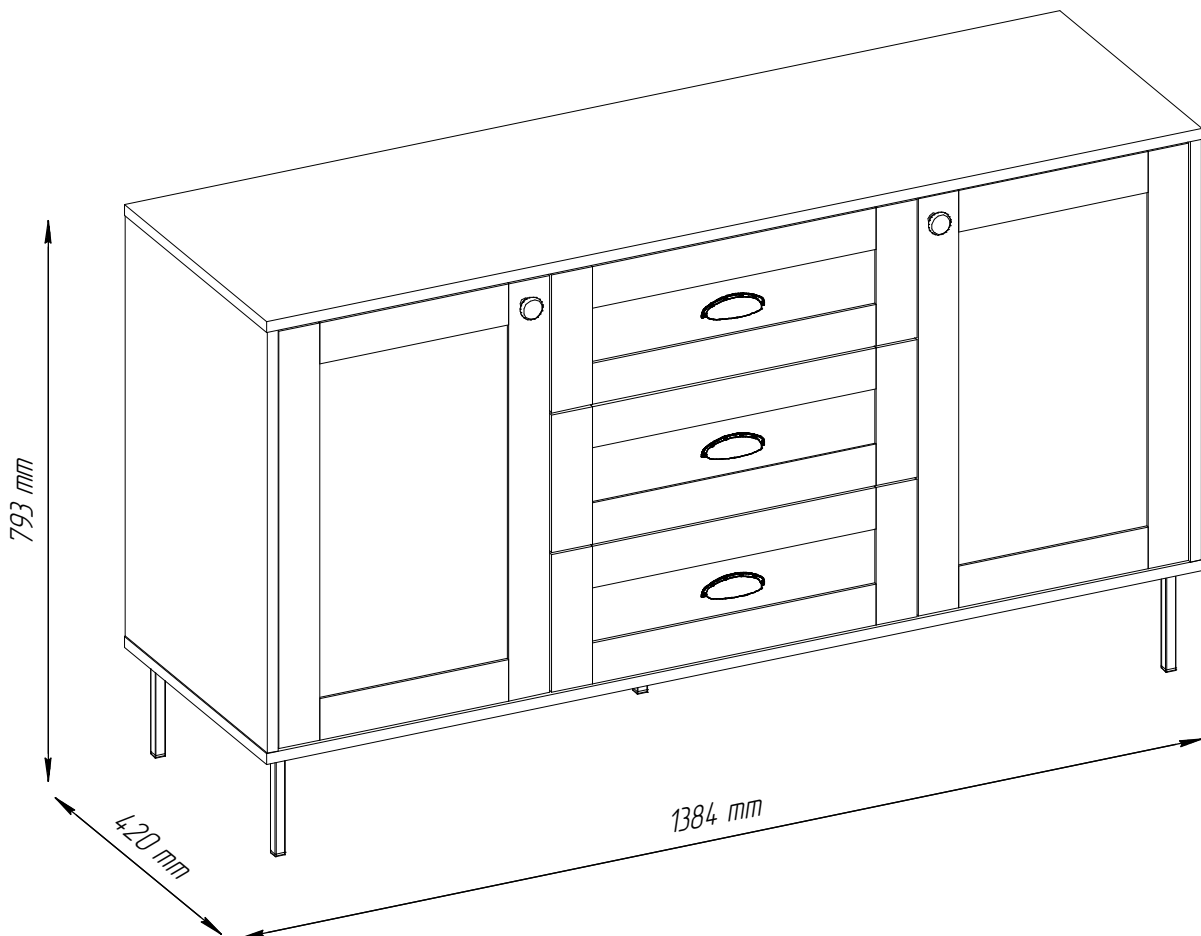

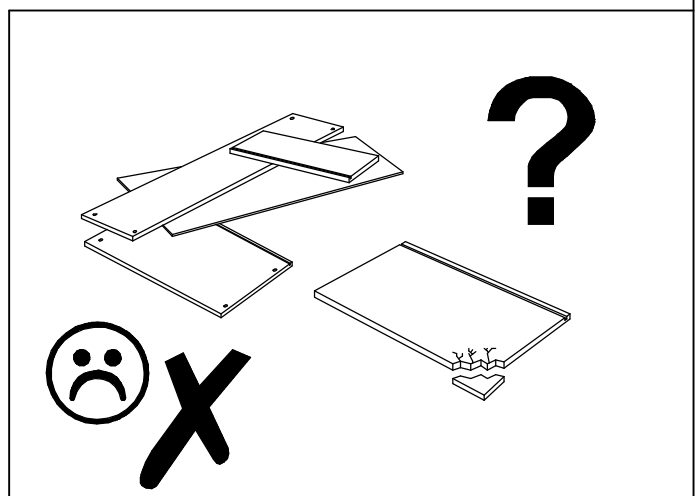
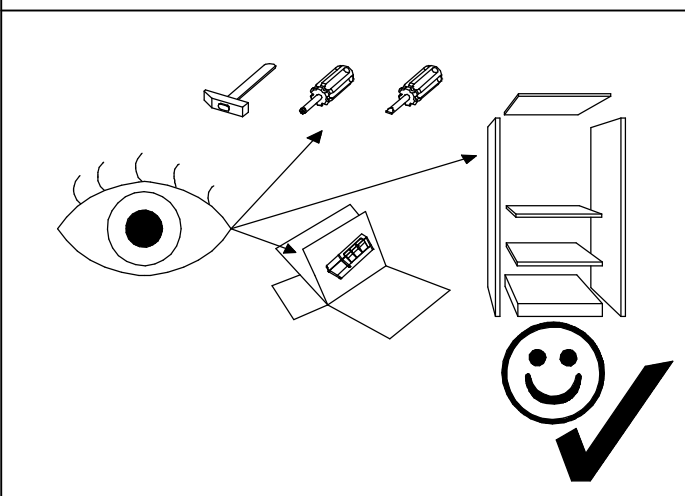
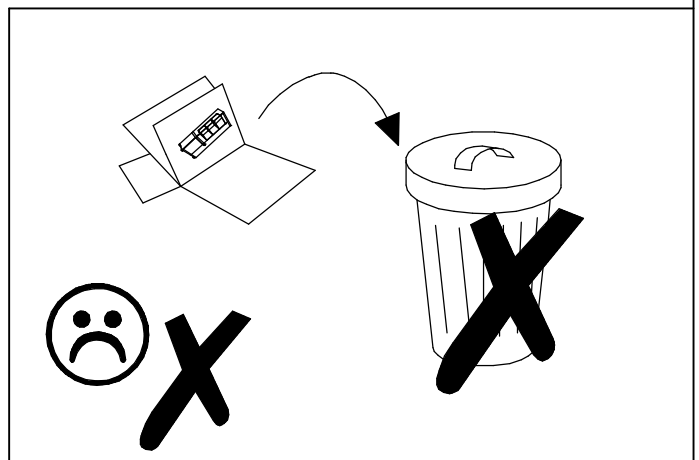
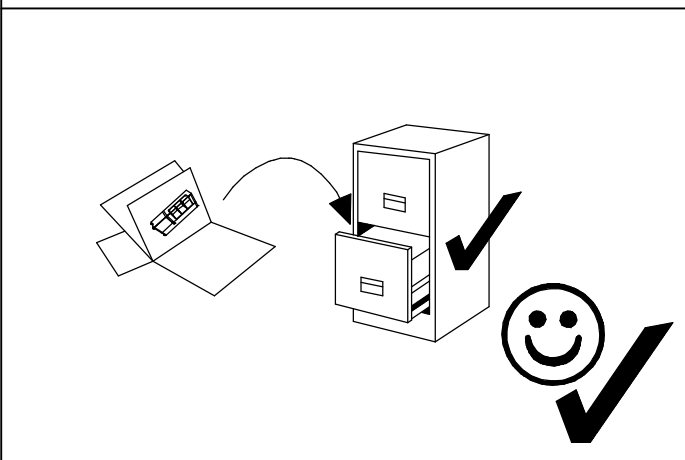
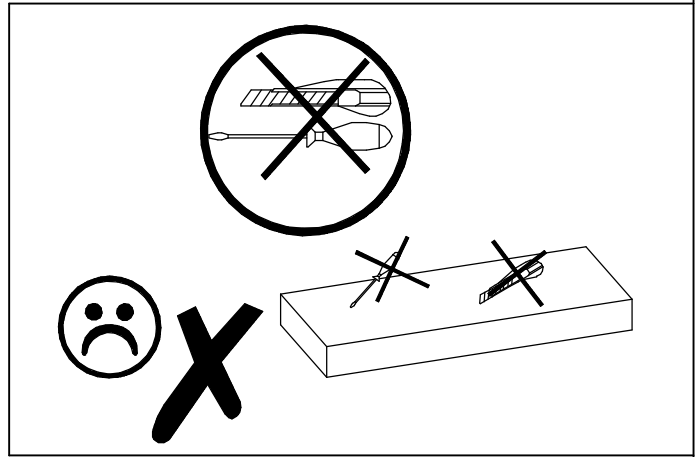
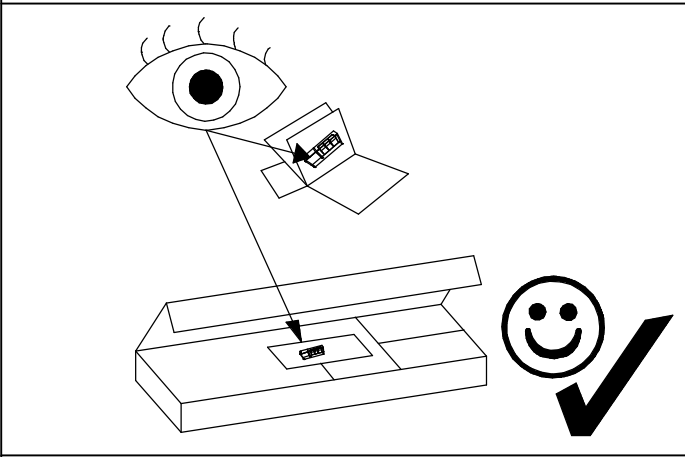

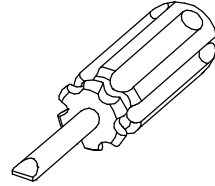
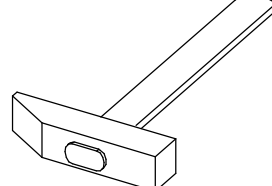
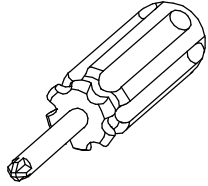
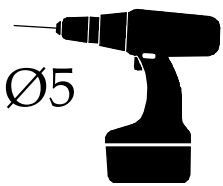
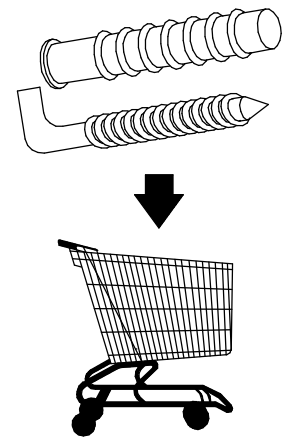
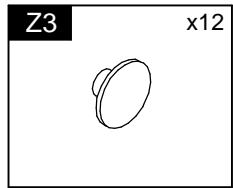
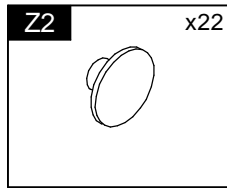
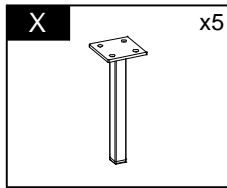
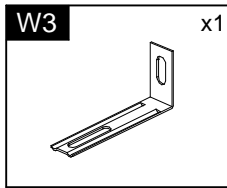
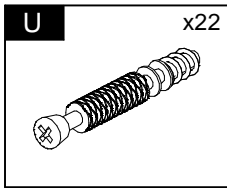
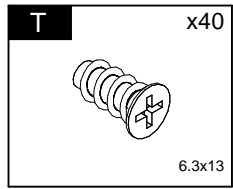
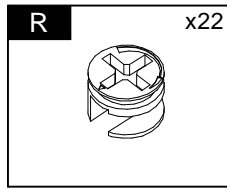
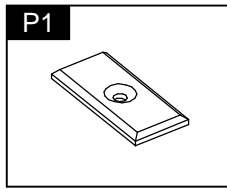
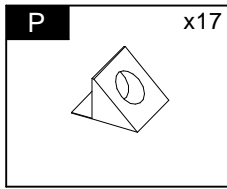
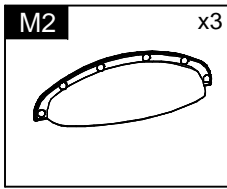
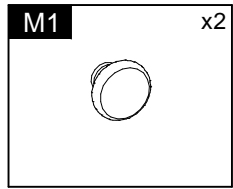
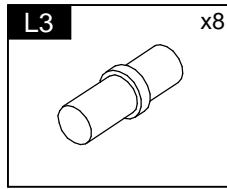
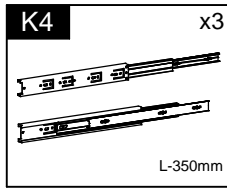
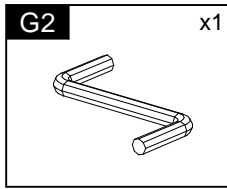
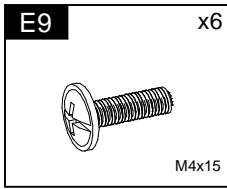
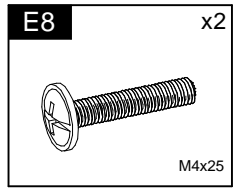
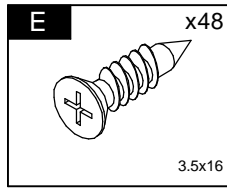
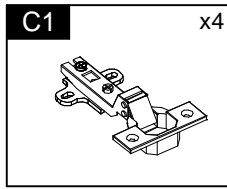
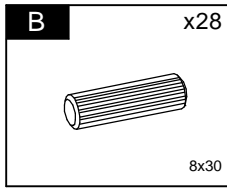
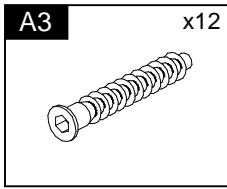
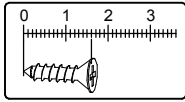

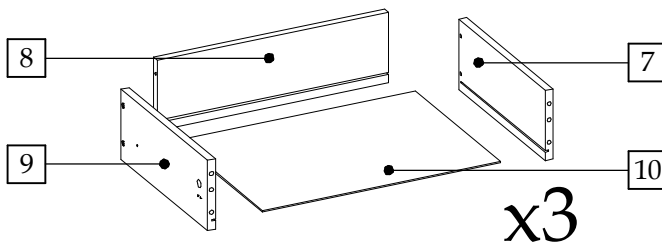

Element symbol	Measurements				Code	Pack
	W	H	T	D		
1	611	419.5	16	2	1002	1/2
2	1384	420	16	1	1004	1/2
3	1384	420	16	1	1005	1/2
4	611	378.5	16	1	1007	1/2
5	611	378.5	16	1	1008	1/2
6	395	370	16	2	N/A	1/2
7	350	140	16	3	1011	1/2
8	469.5	140	16	3	1012	1/2
9	350	140	16	3	1013	1/2
10	483	346	3	3	N/A	2/2
11	625	410	3	2	N/A	1/2
12	625	271	3	2	N/A	1/2
13	606	400	19	2	3001	2/2
14	540	200	19	3	3002	2/2

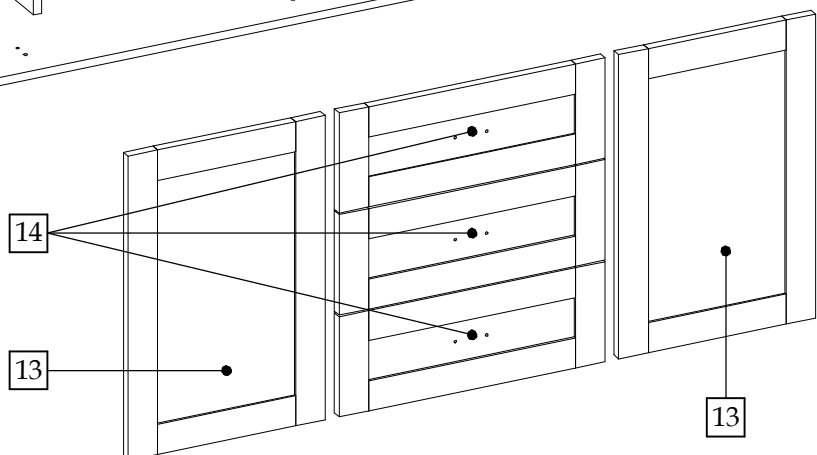
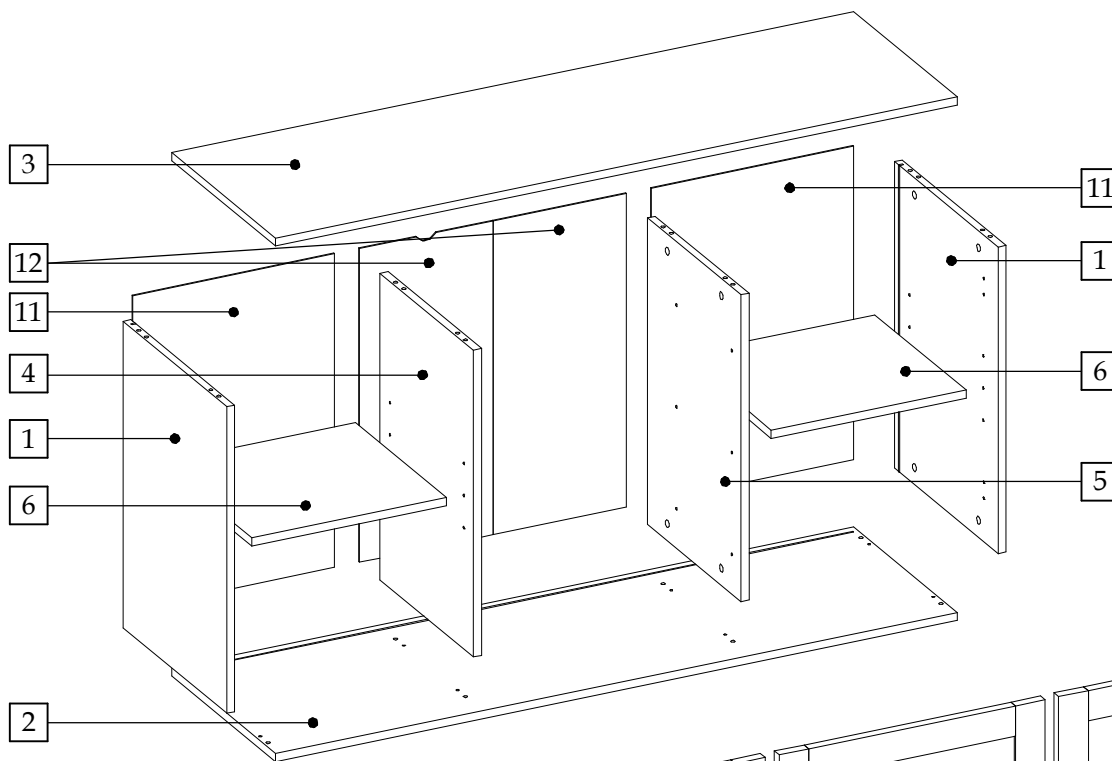

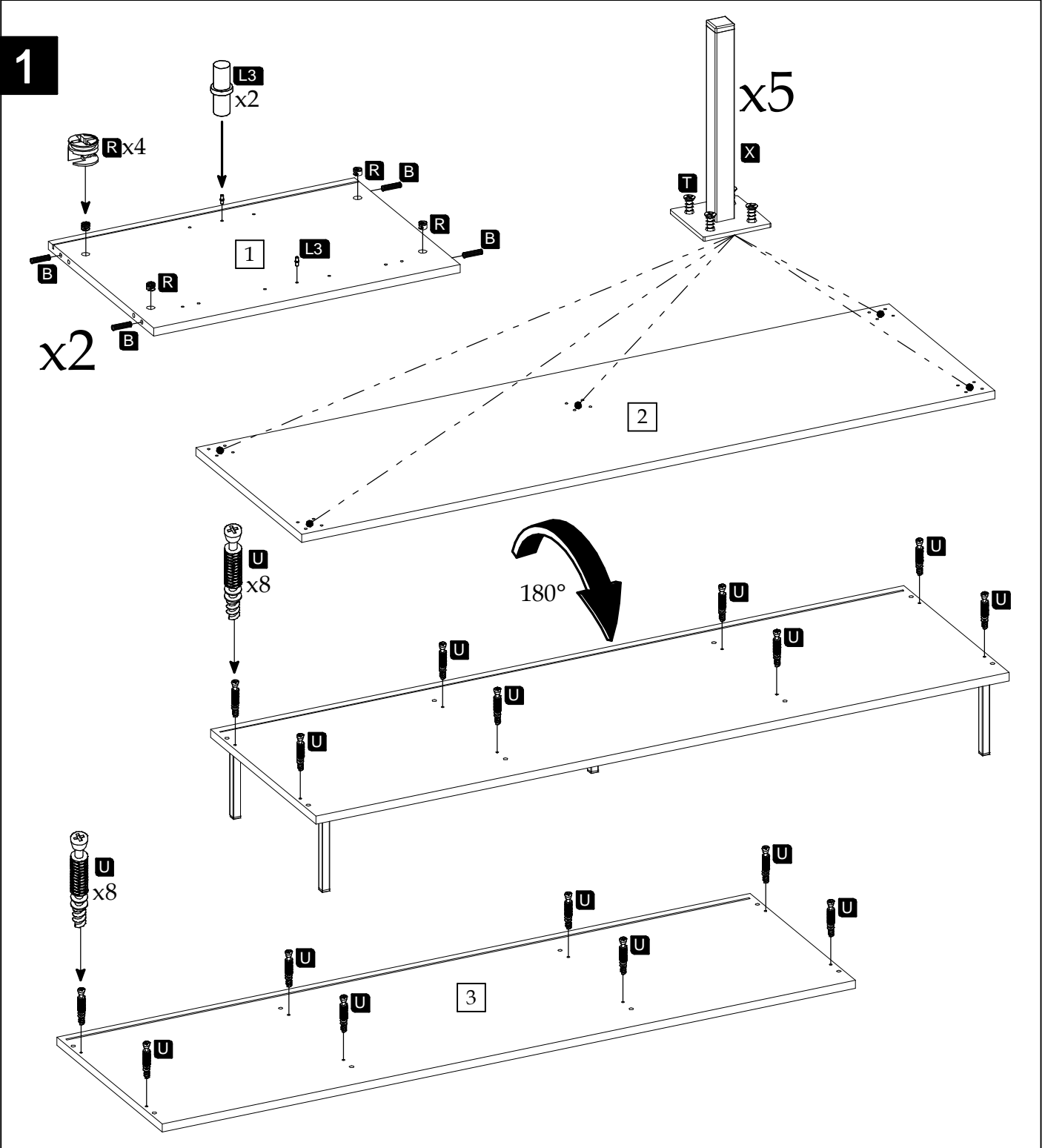
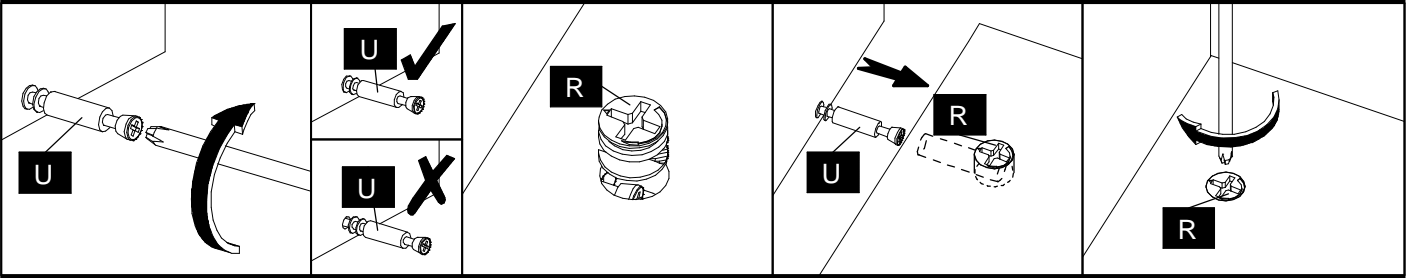

2

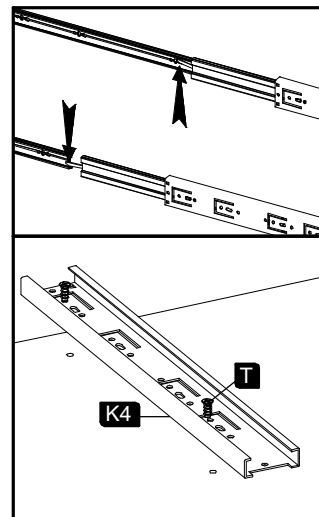
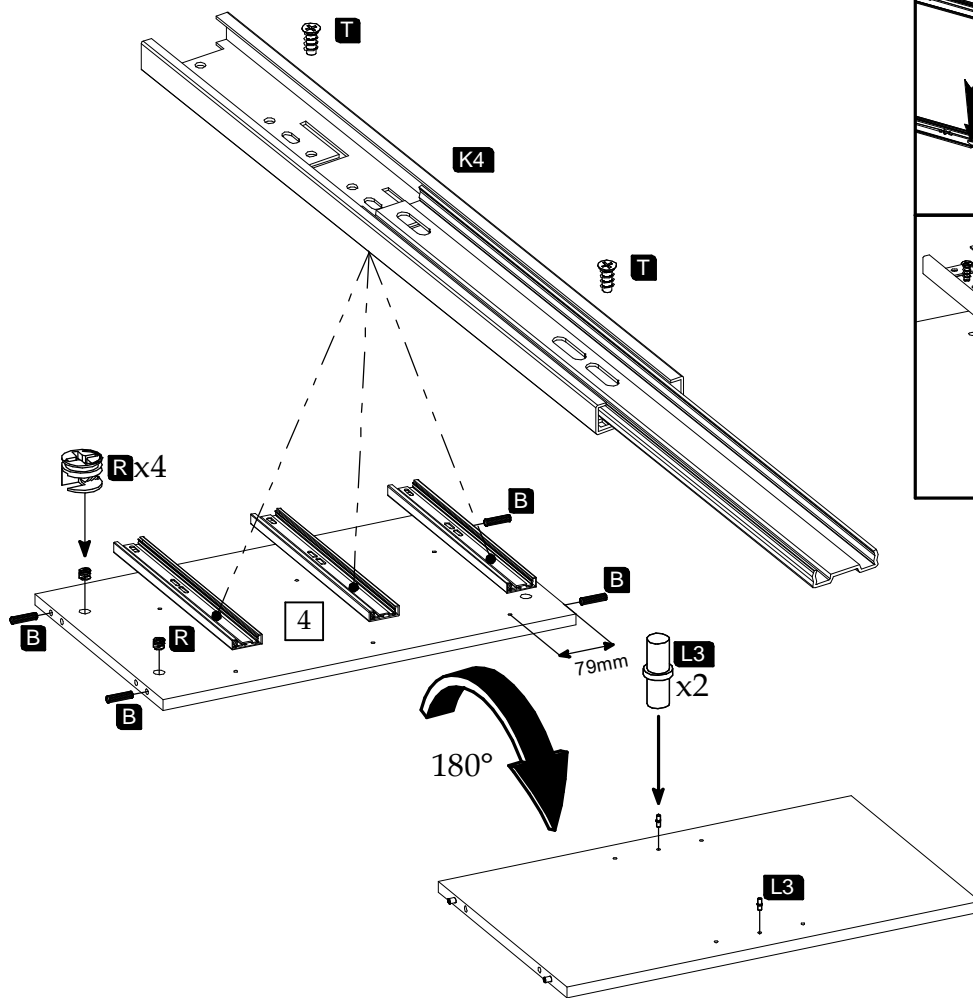

3

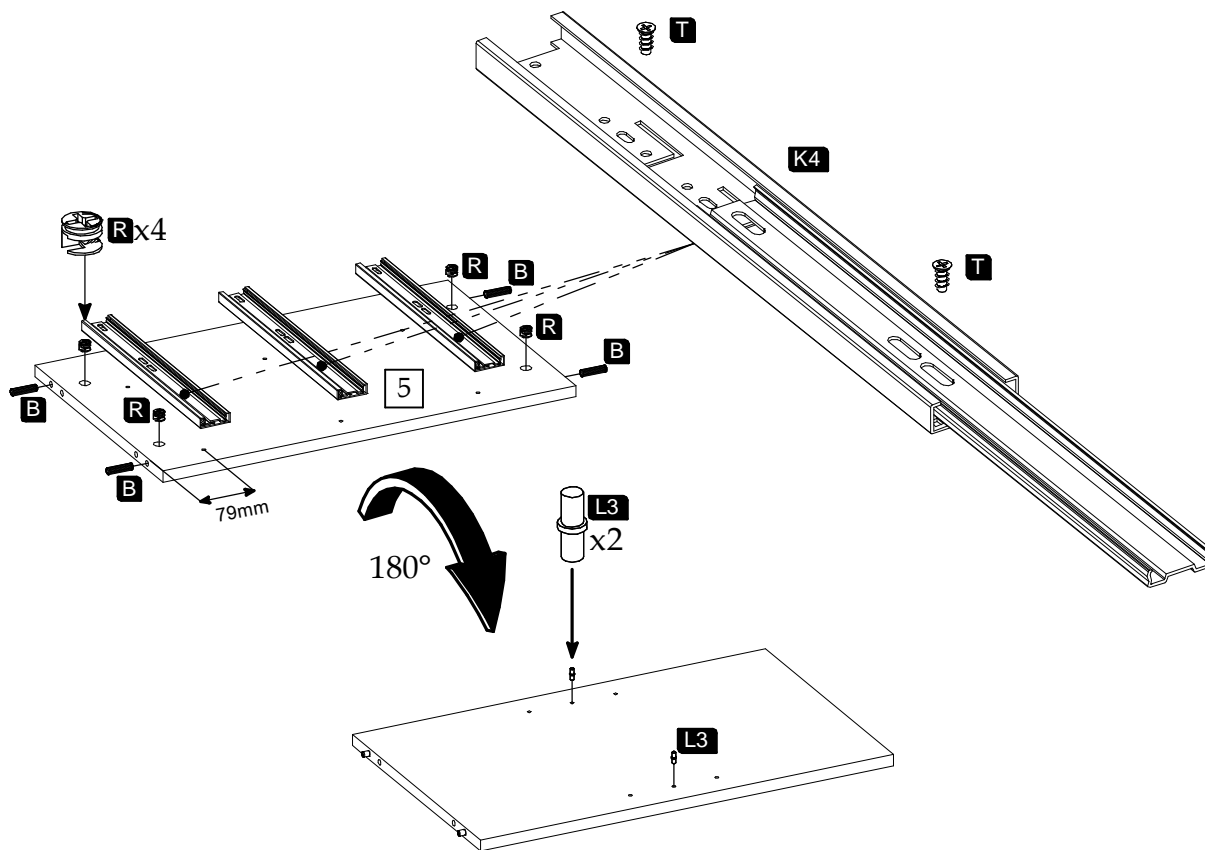

4

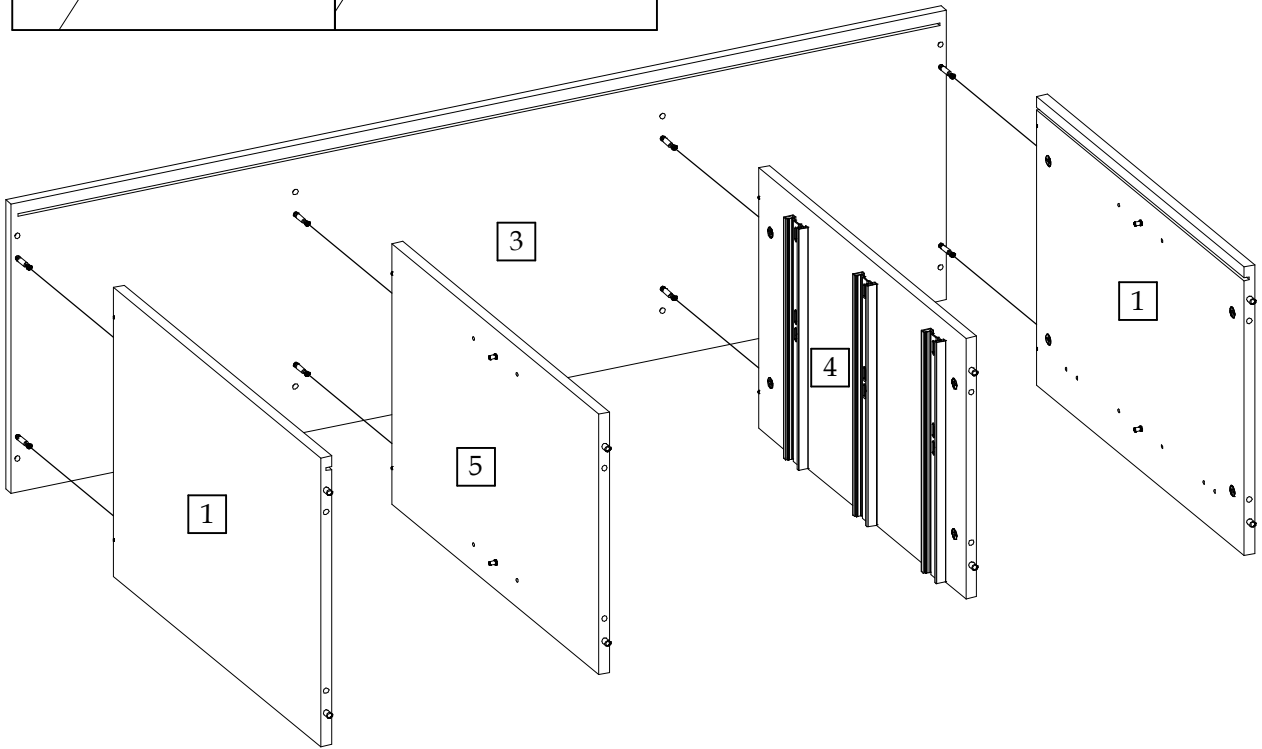
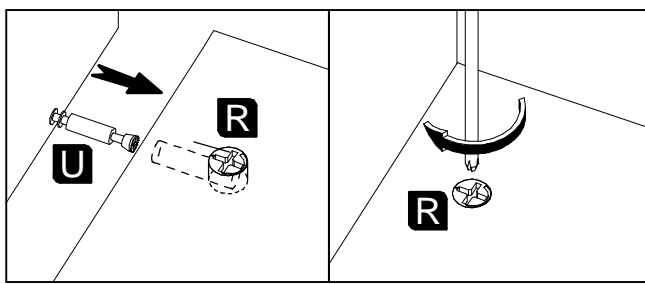

5

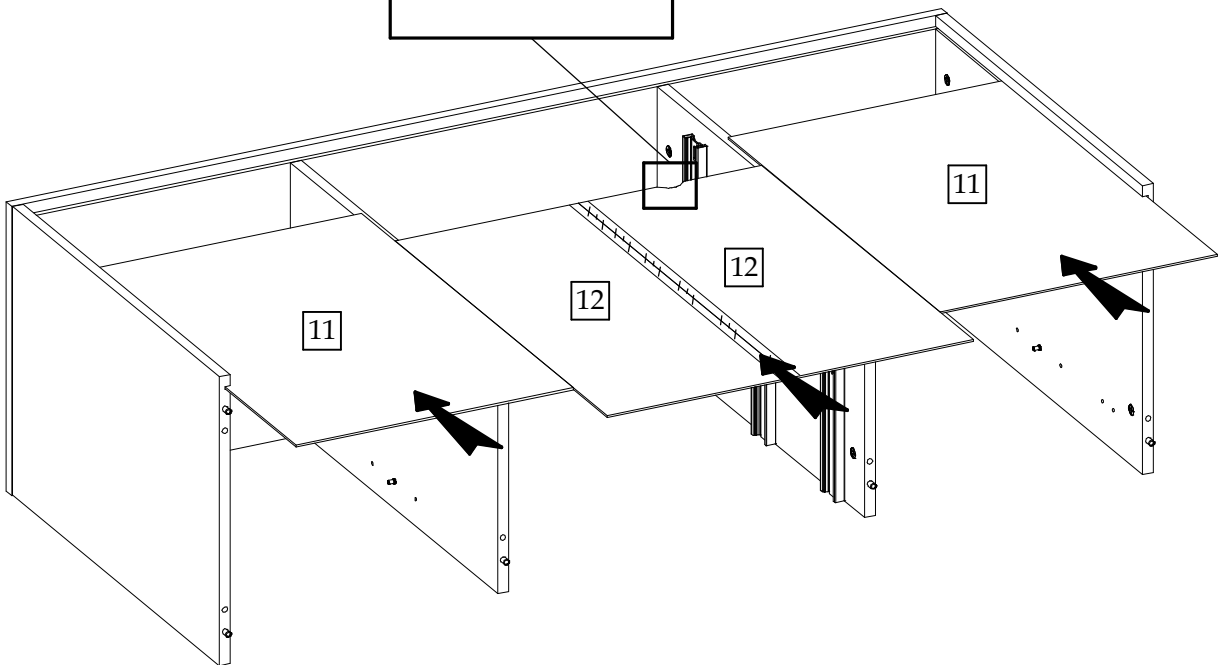
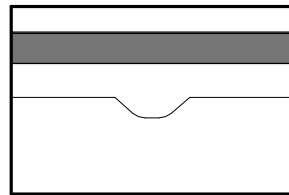

6

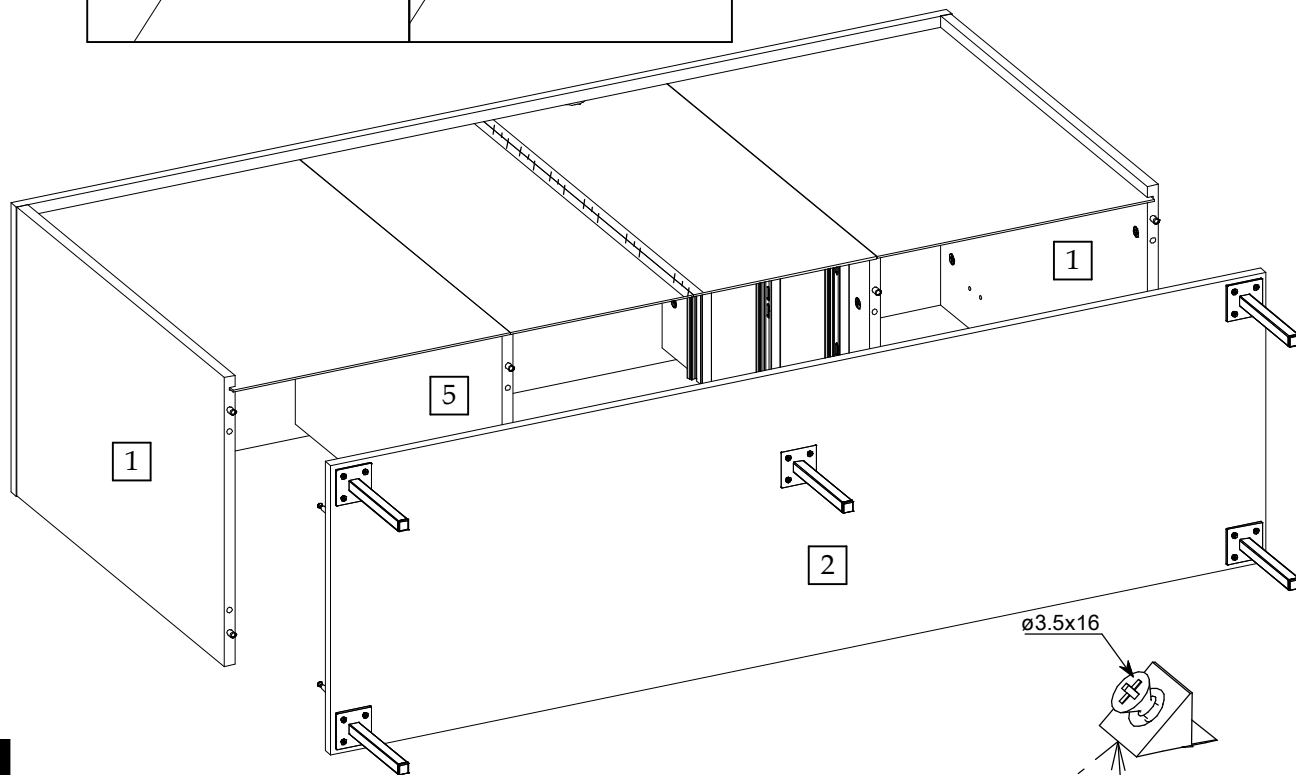
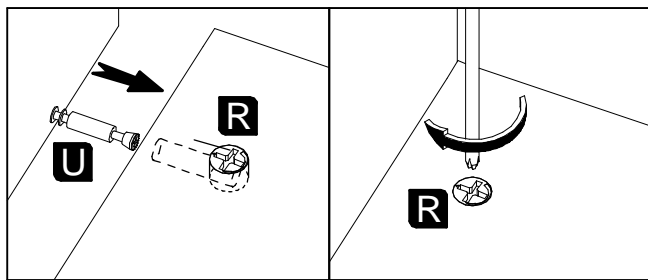

7

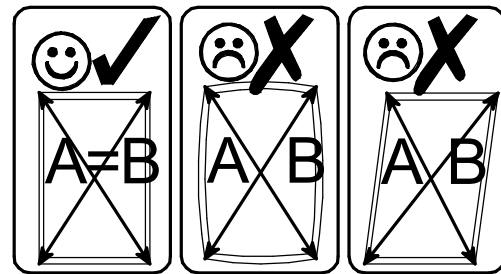
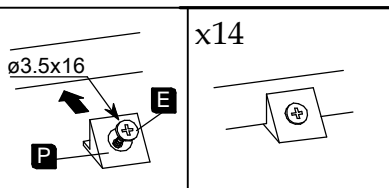
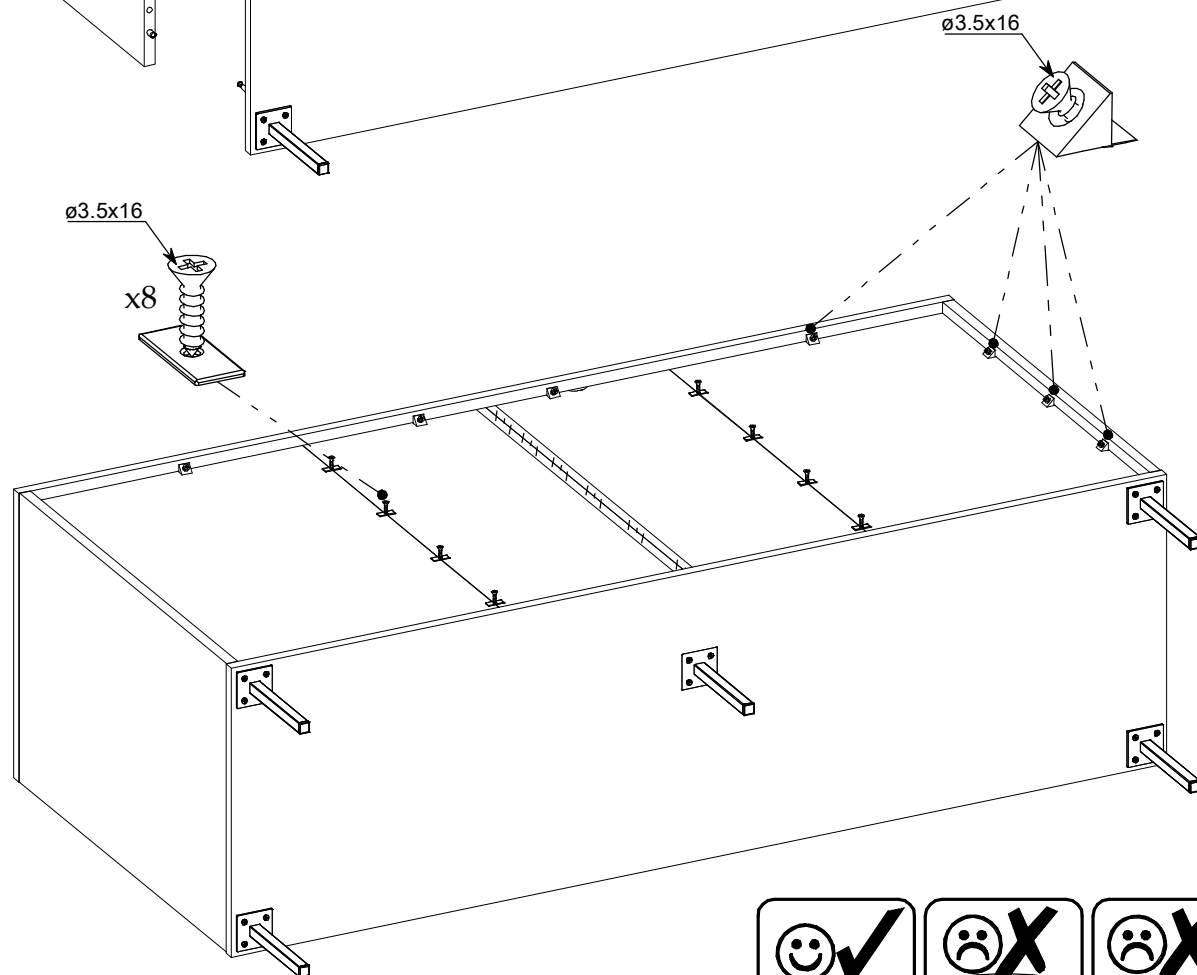

8



