

# HENRY

## Type F

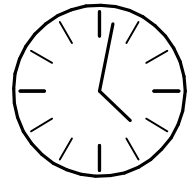

60 min

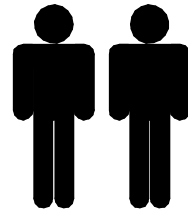

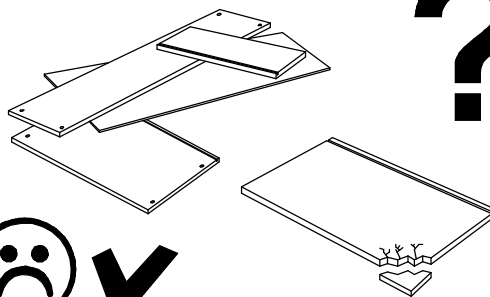
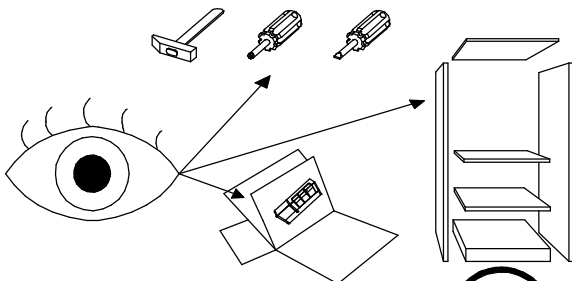
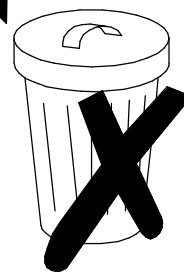
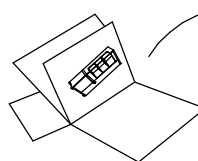
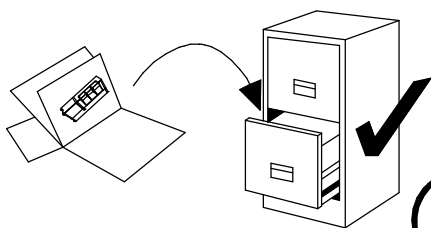
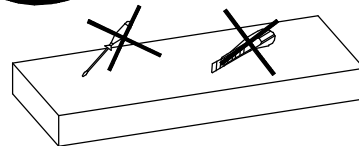
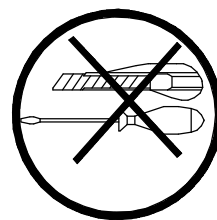
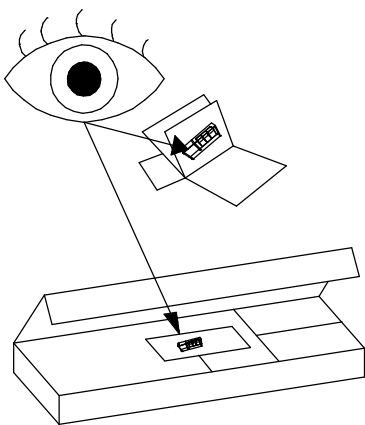

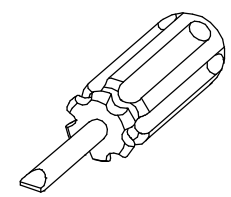
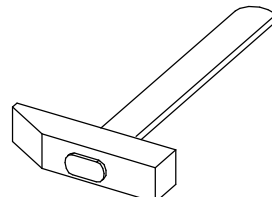
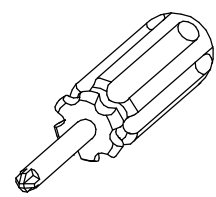
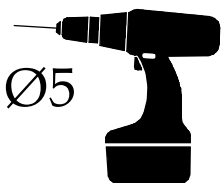
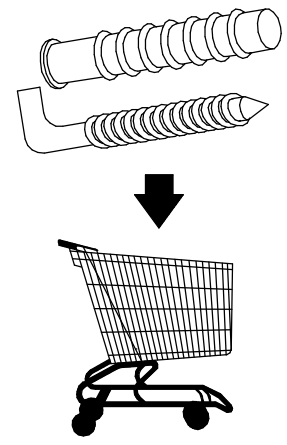
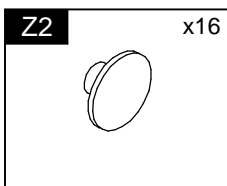
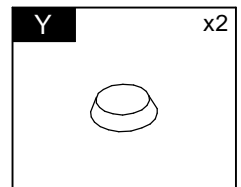
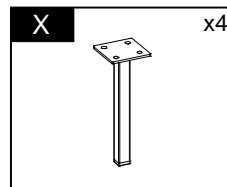
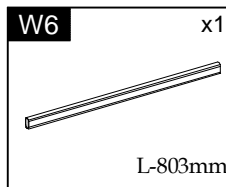
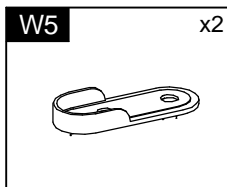
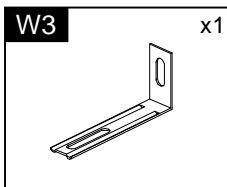
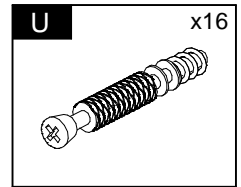
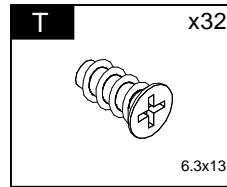
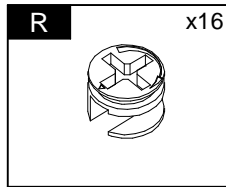
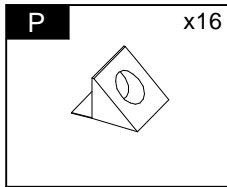
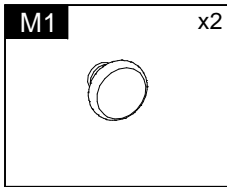
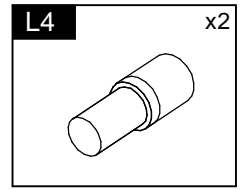
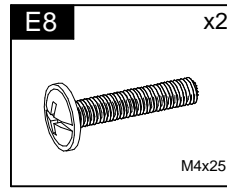
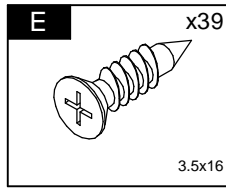
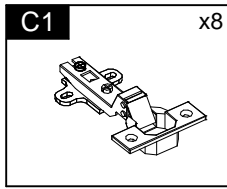
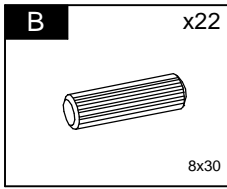
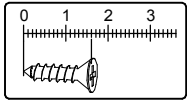

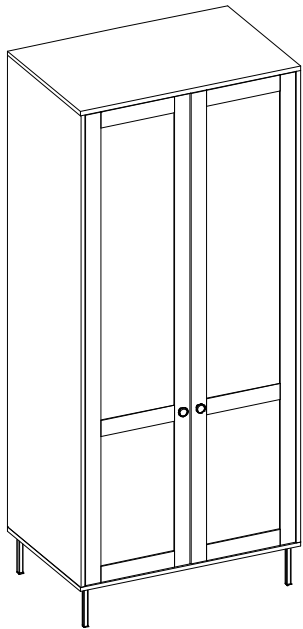

Element symbol	Measurements				Code	Pack
1	1768	559.5	16	1	1002	1/2
2	1768	559.5	16	1	1003	1/2
3	841	560	16	1	1004	1/2
4	841	560	16	1	1005	1/2
5	807	519	16	1	1007	1/2
6	807	160	16	1	1036	1/2
7	1782	410	3	2	N/A	1/2
8	1763	400	19	1	3001	2/2
9	1763	400	19	1	3002	2/2

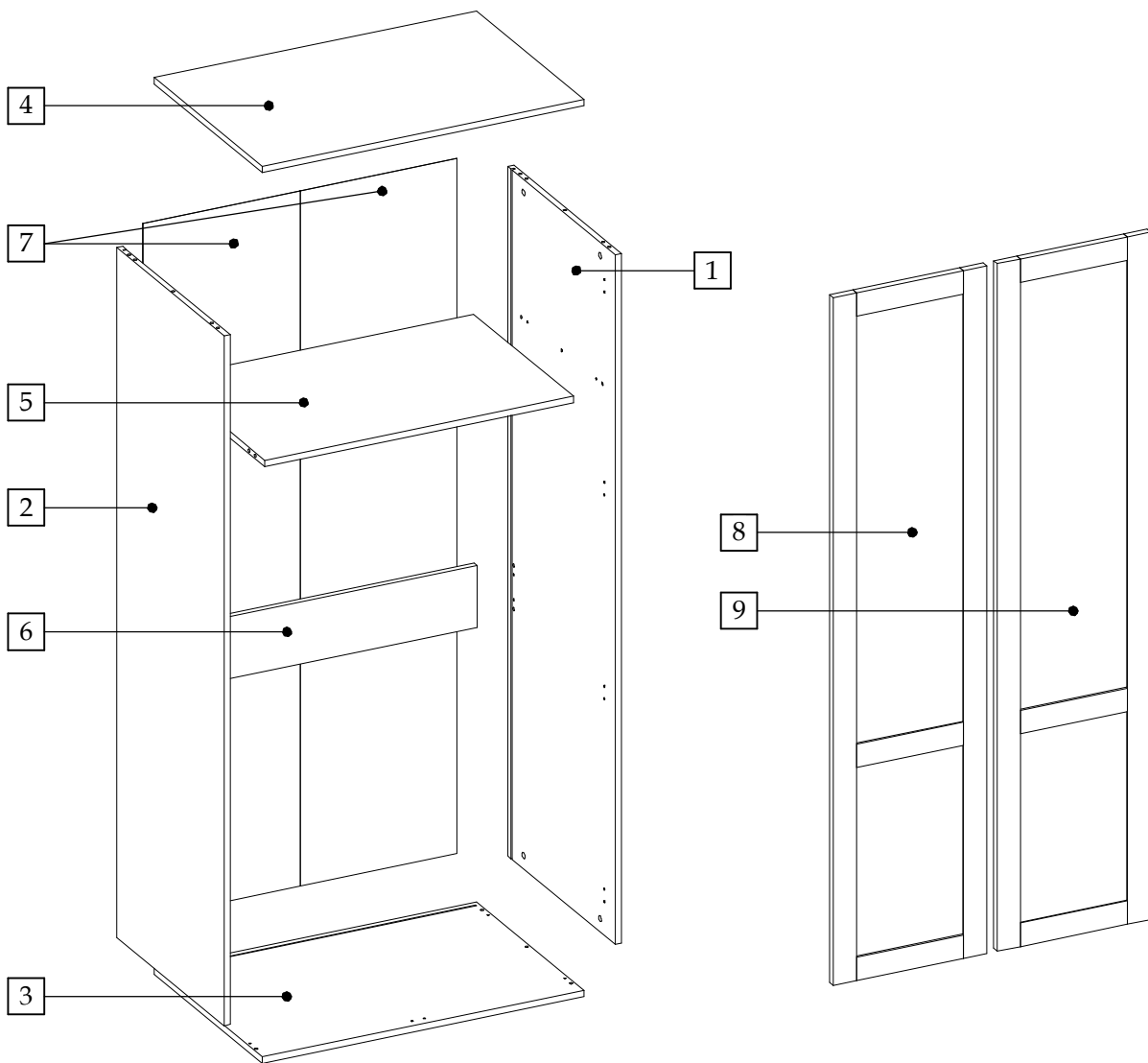



1

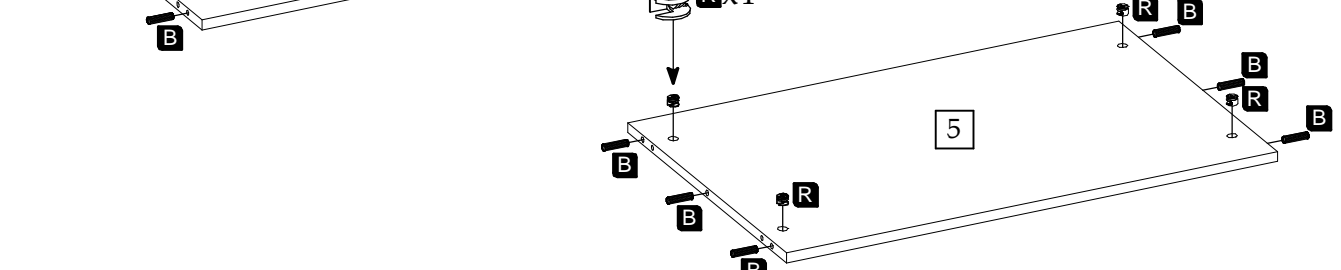
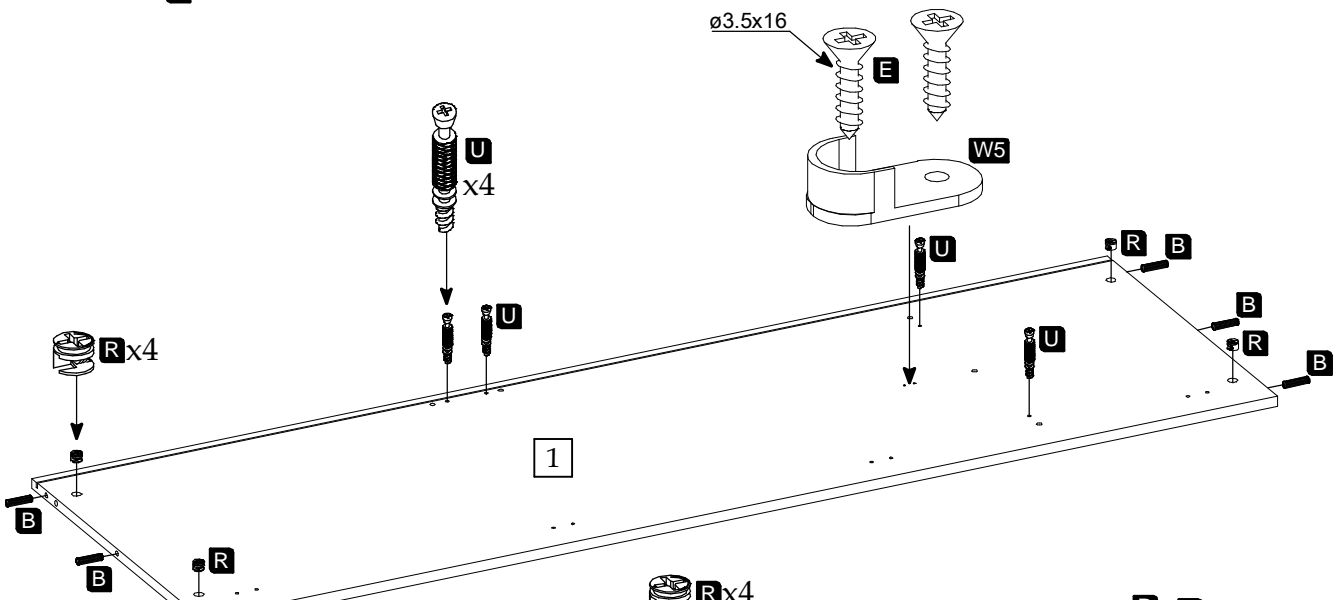
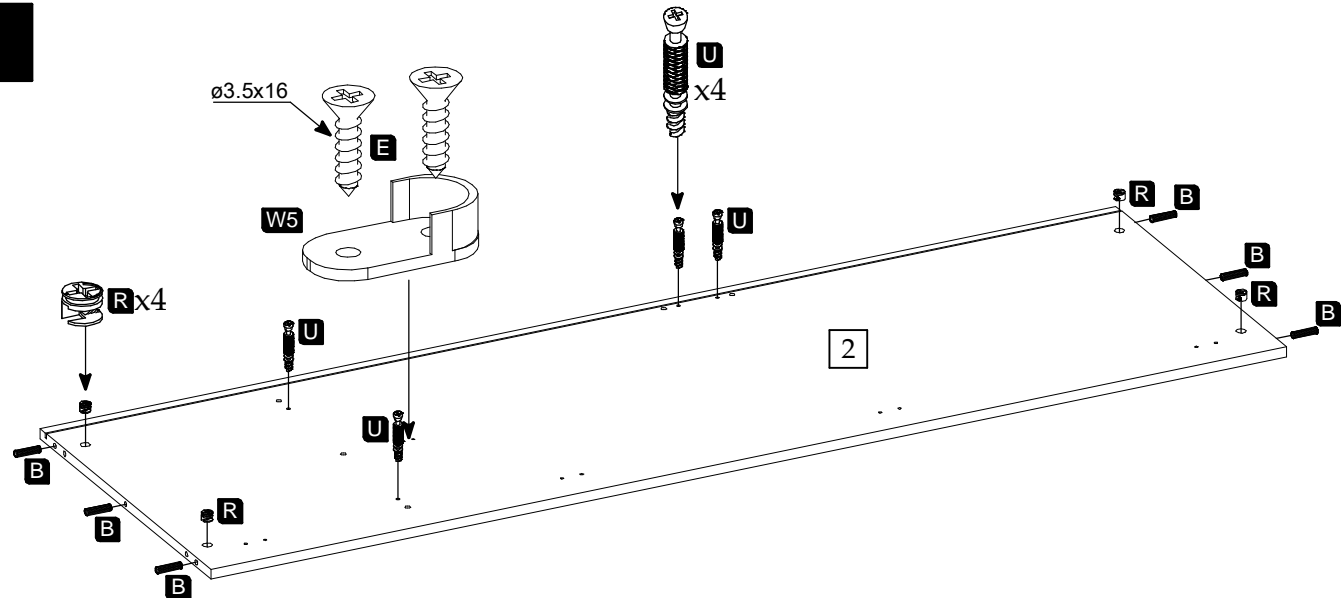

2

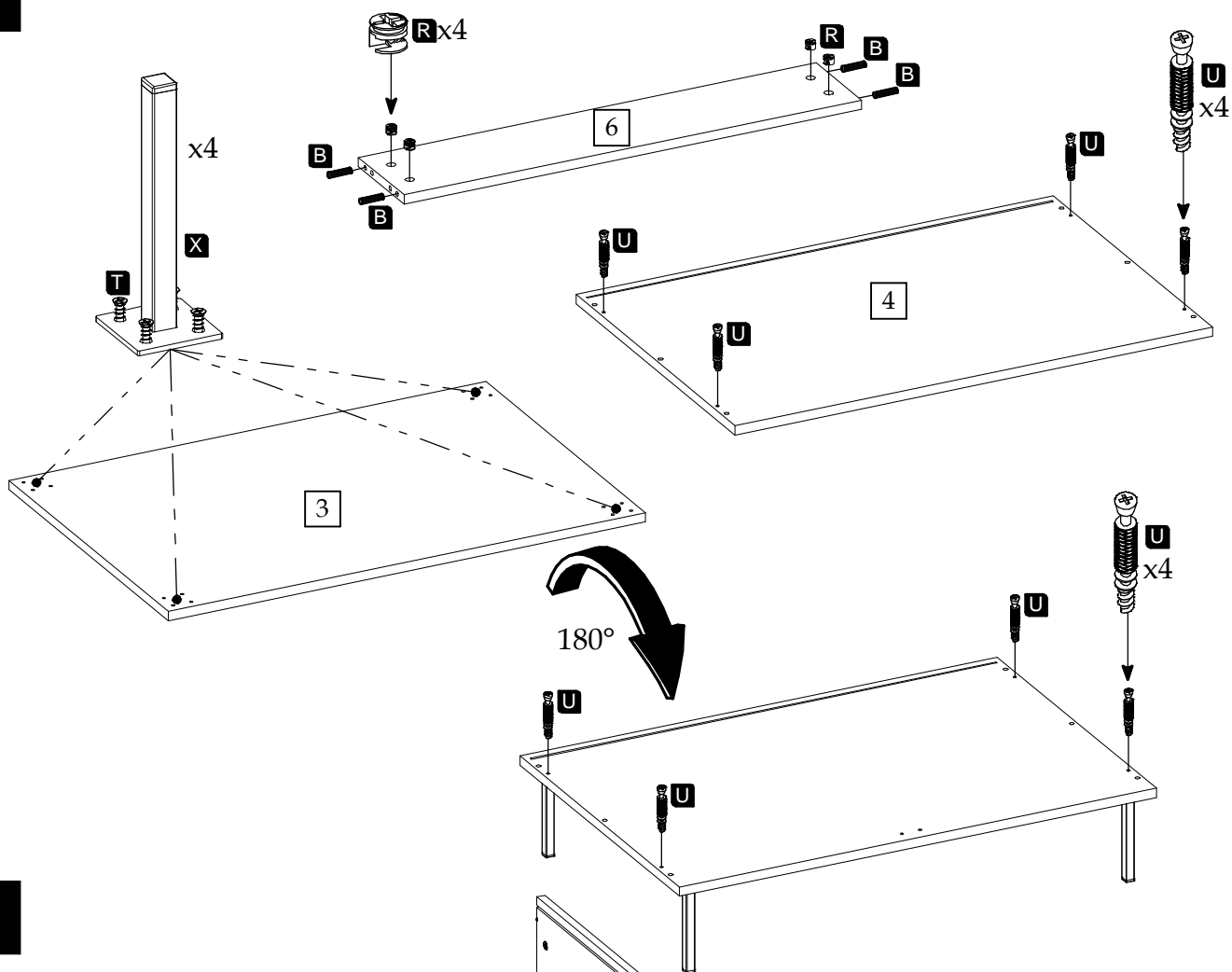

3

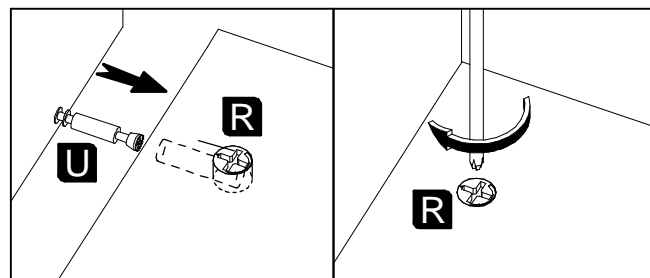
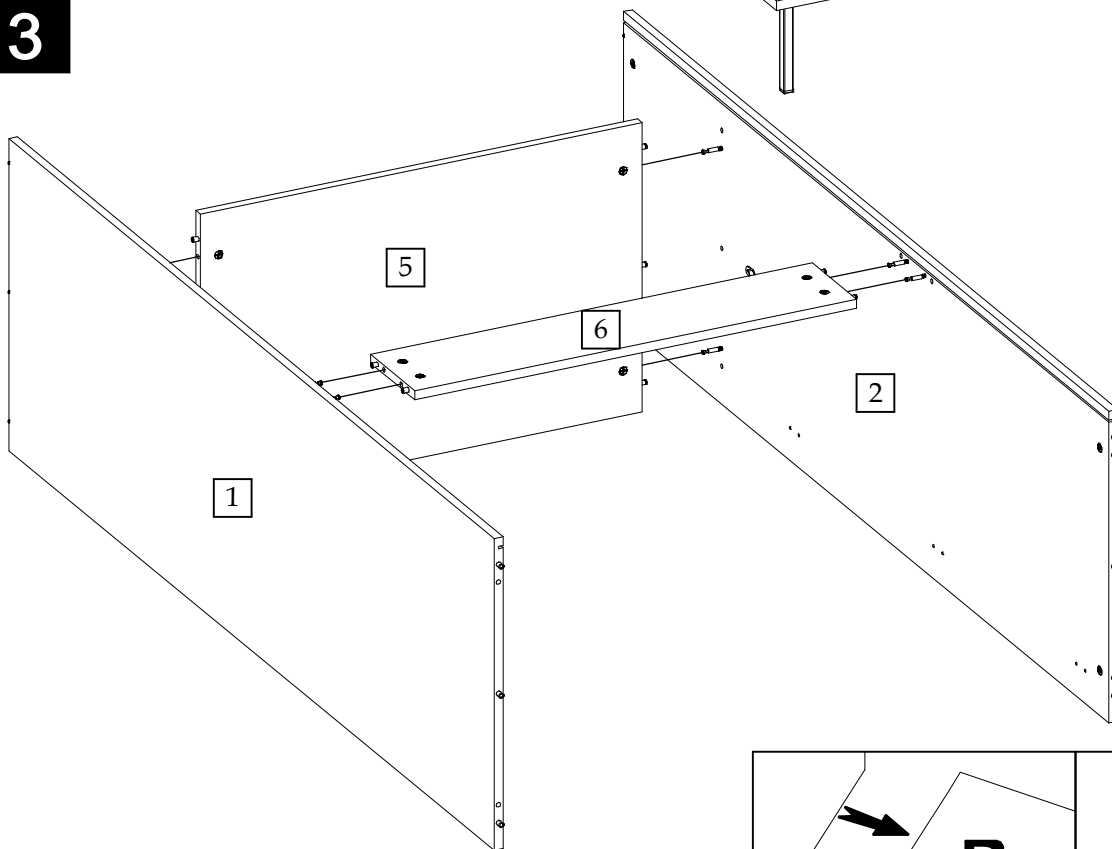

4

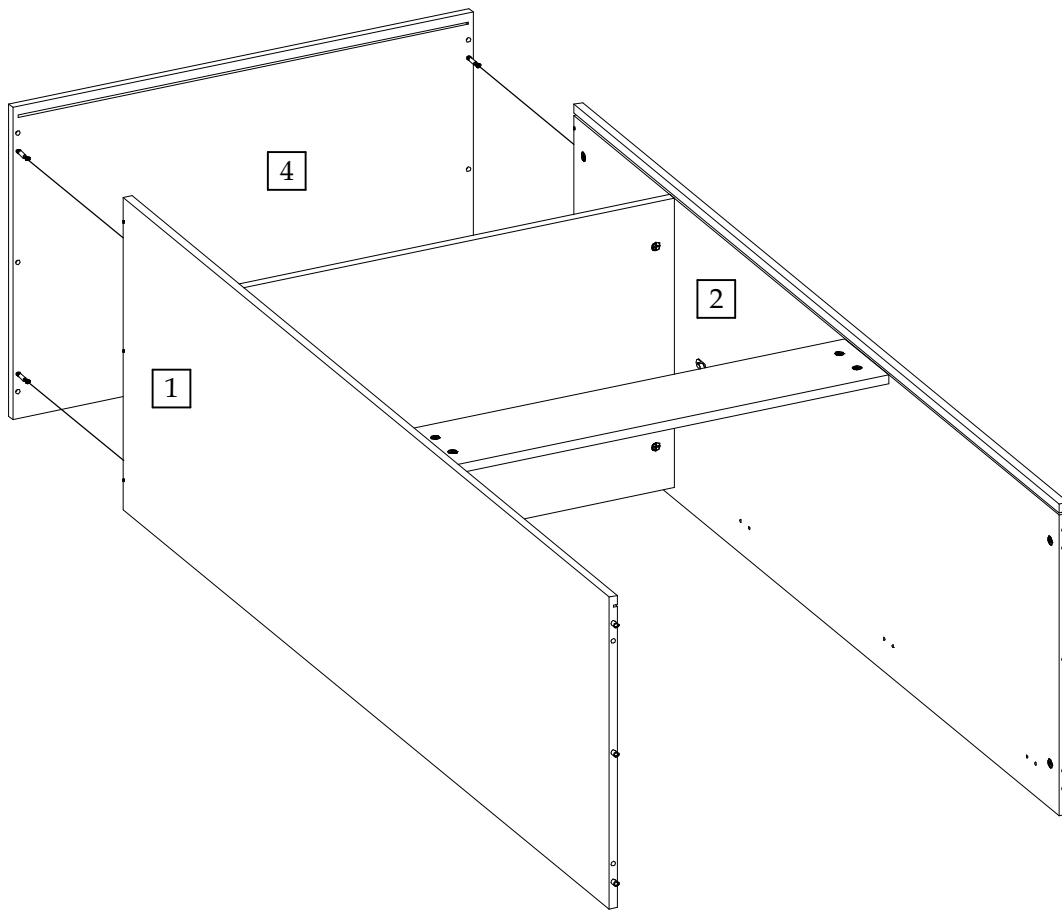

5

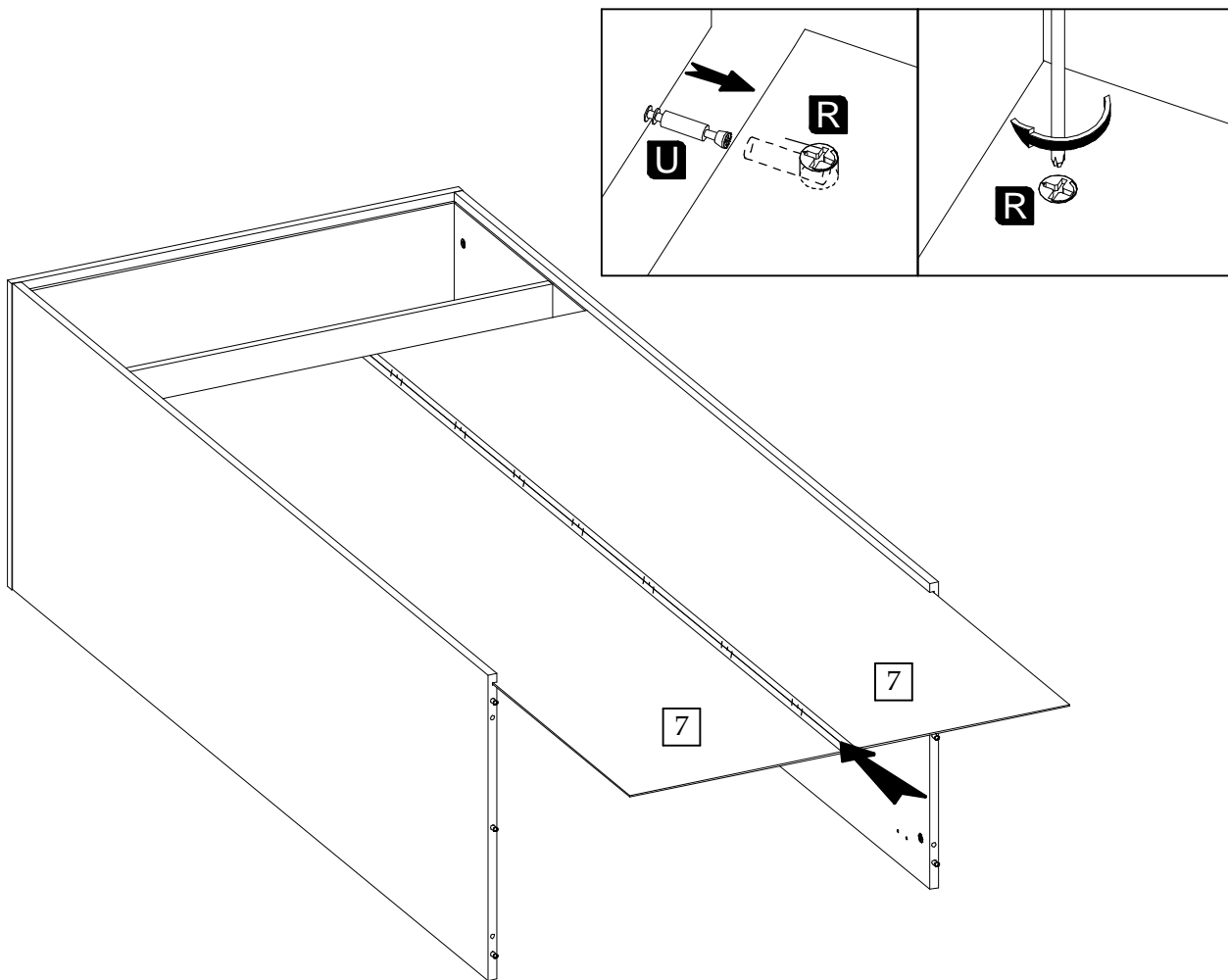

6

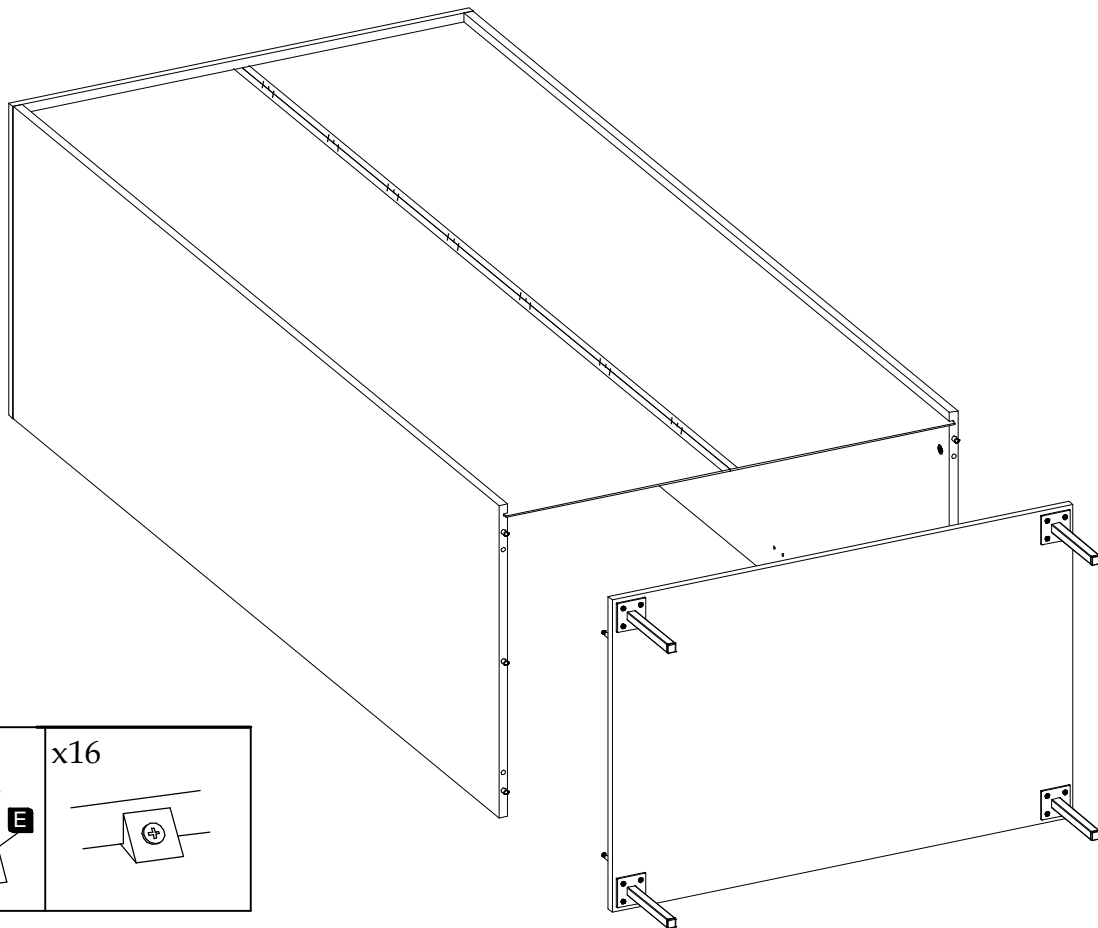

7

