

HENRY

Type H

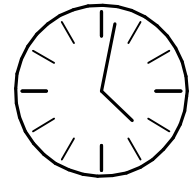

75 min

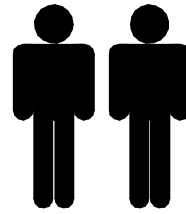
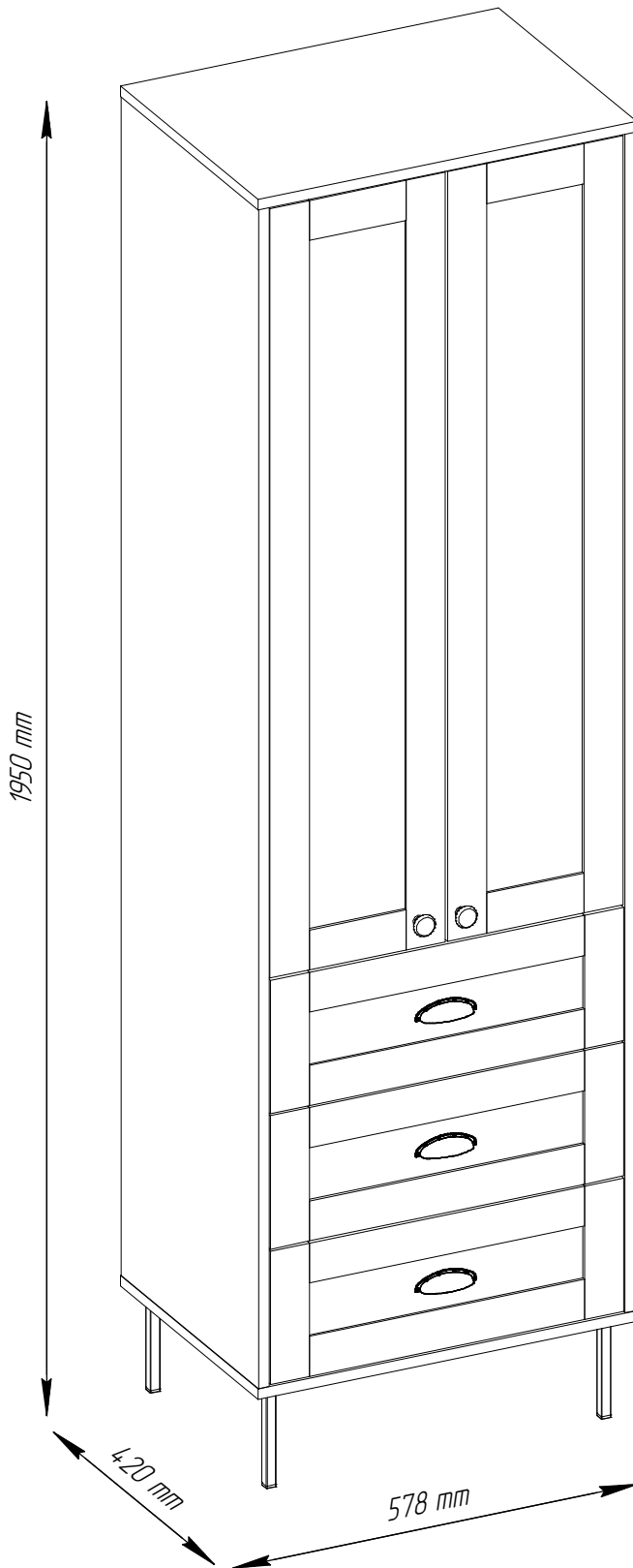
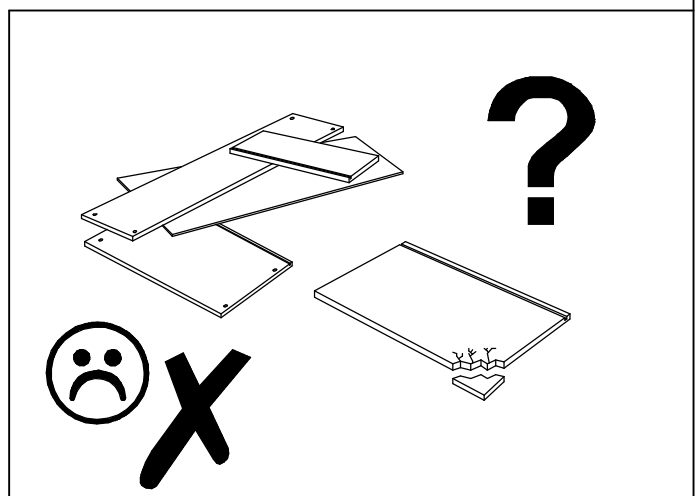
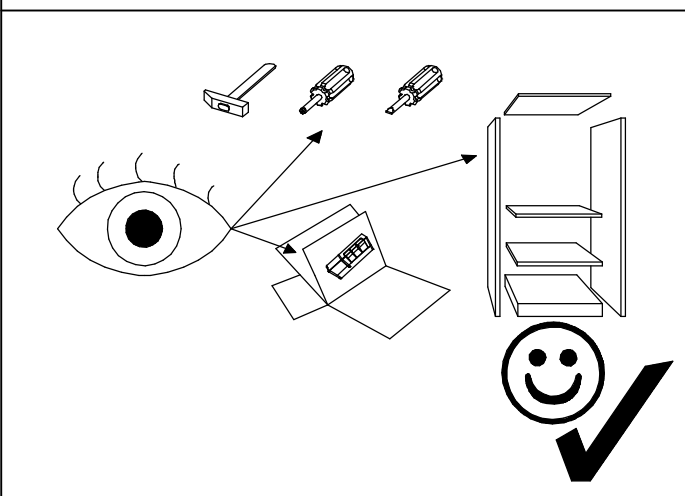
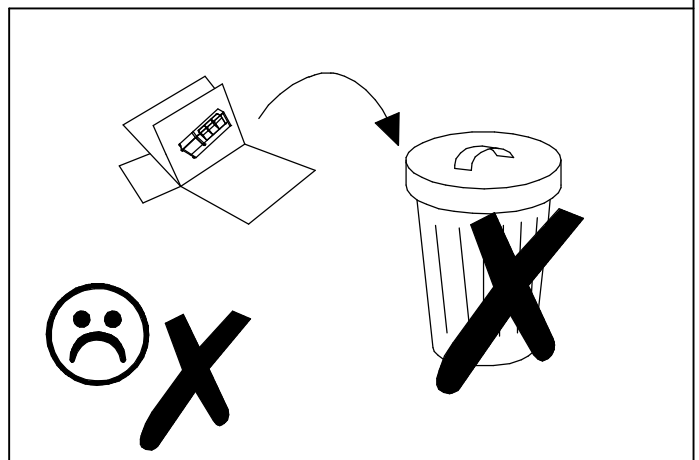
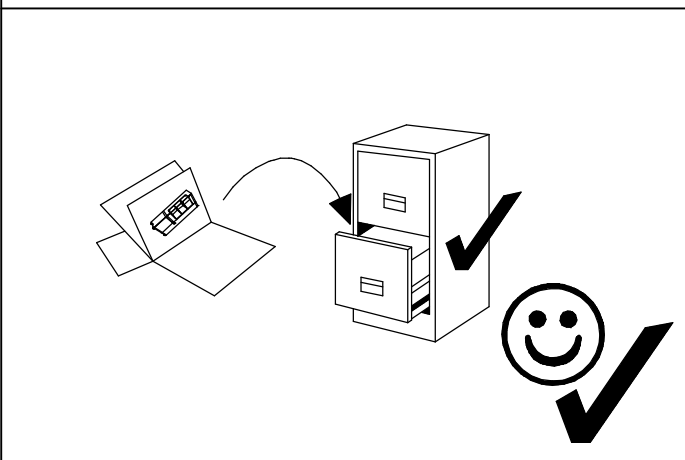
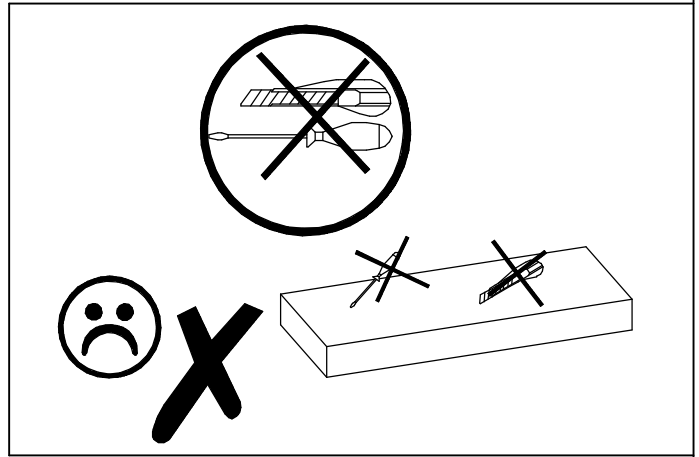
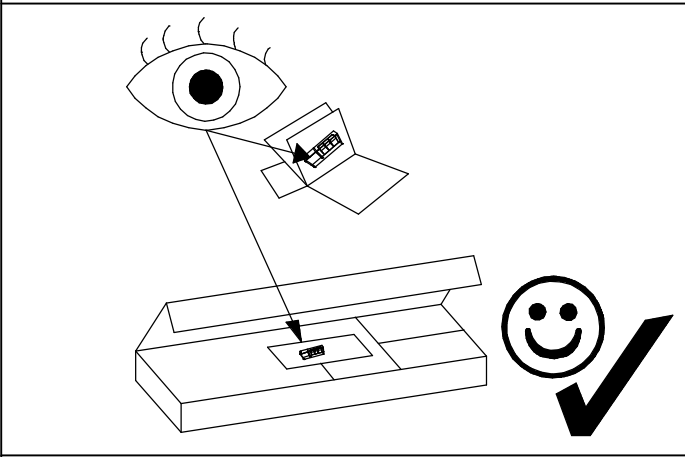

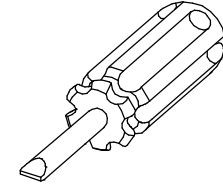
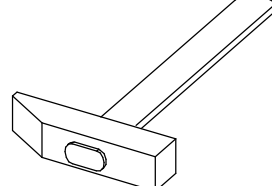
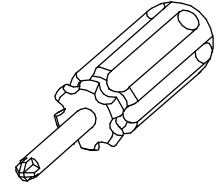
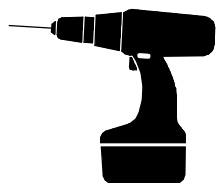
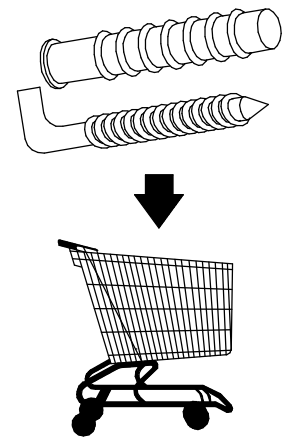
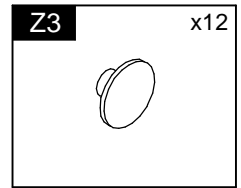
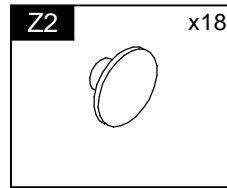
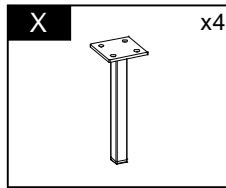
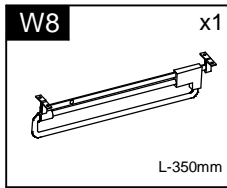
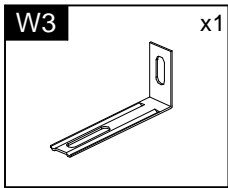
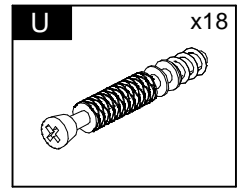
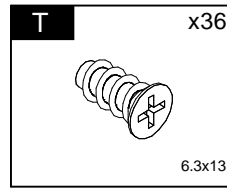
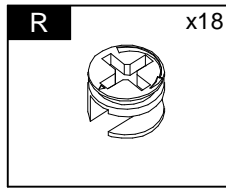
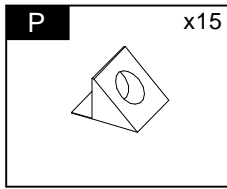
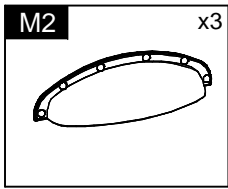
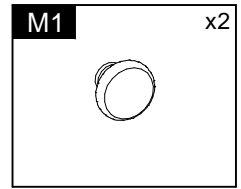
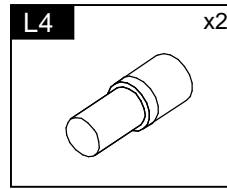
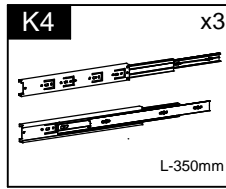
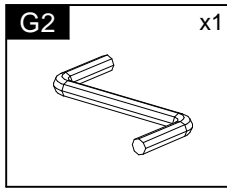
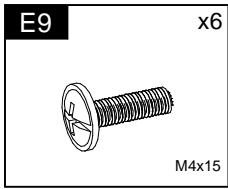
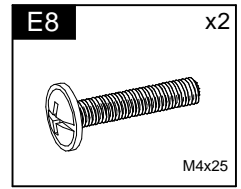
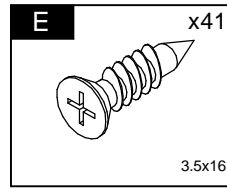
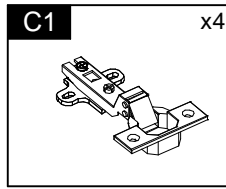
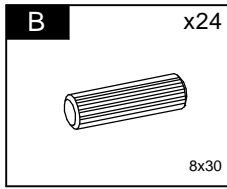
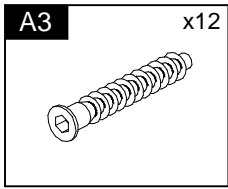
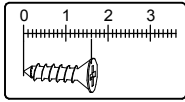
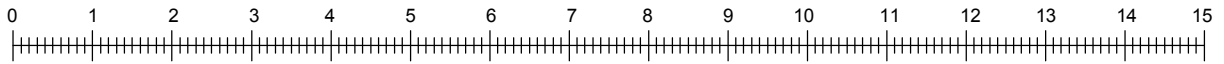

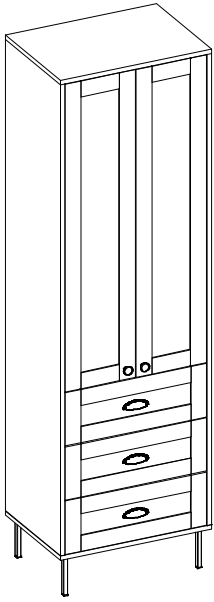

Element symbol	Measurements				Code	Pack
	1	2	3	4		
1	1768	419.5	16	1	1002	1/2
2	1768	419.5	16	1	1003	1/2
3	578	420	16	1	1004	1/2
4	578	420	16	1	1005	1/2
5	544	379	16	1	1007	1/2
6	350	140	16	3	1009	1/2
7	486.5	140	16	3	1010	1/2
8	350	140	16	3	1011	1/2
9	500	346	3	3	N/A	1/2
10	1782	279	3	2	N/A	1/2
11	540	200	19	3	3003	2/2
12	1154	268	19	2	3004	2/2

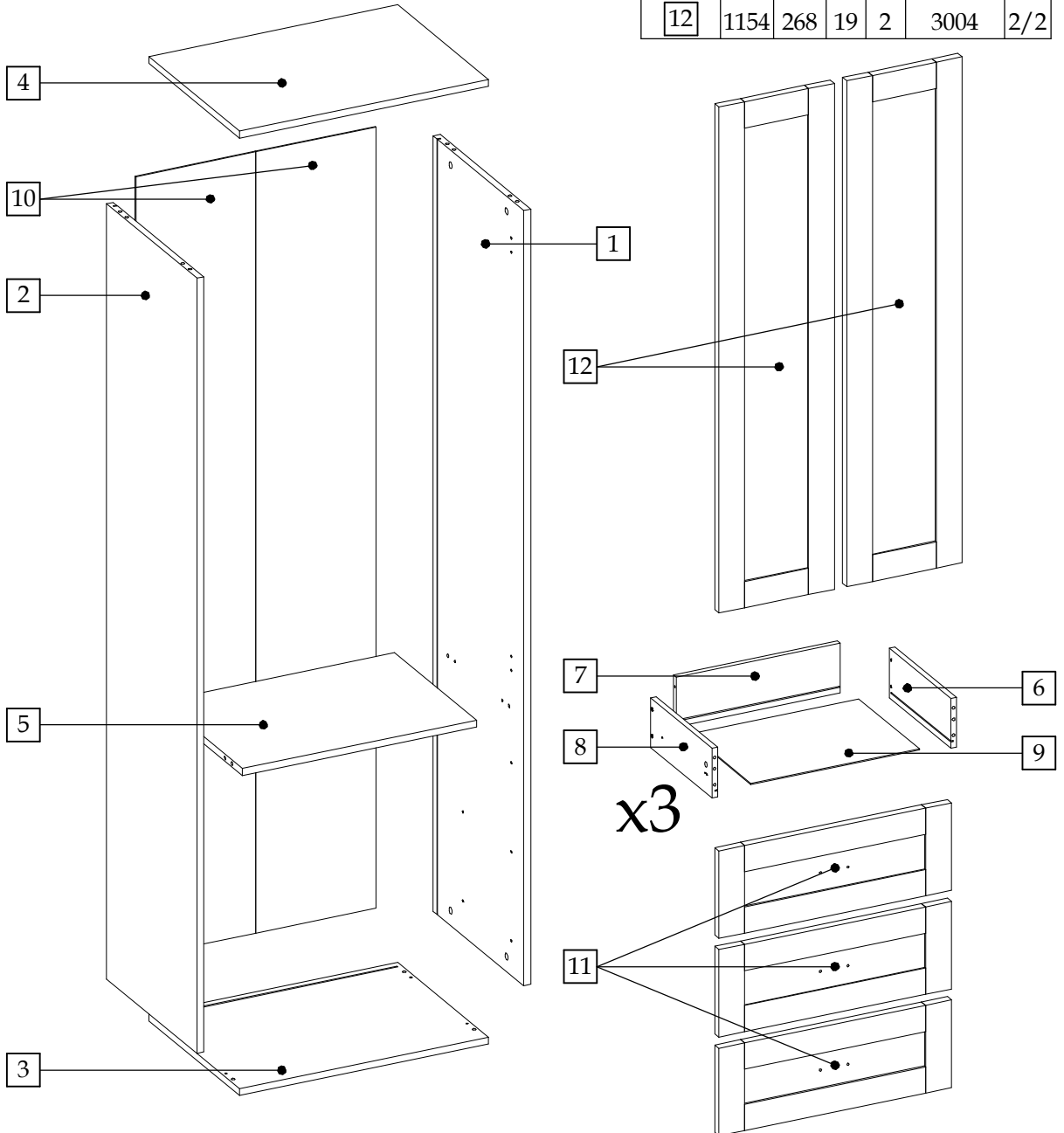

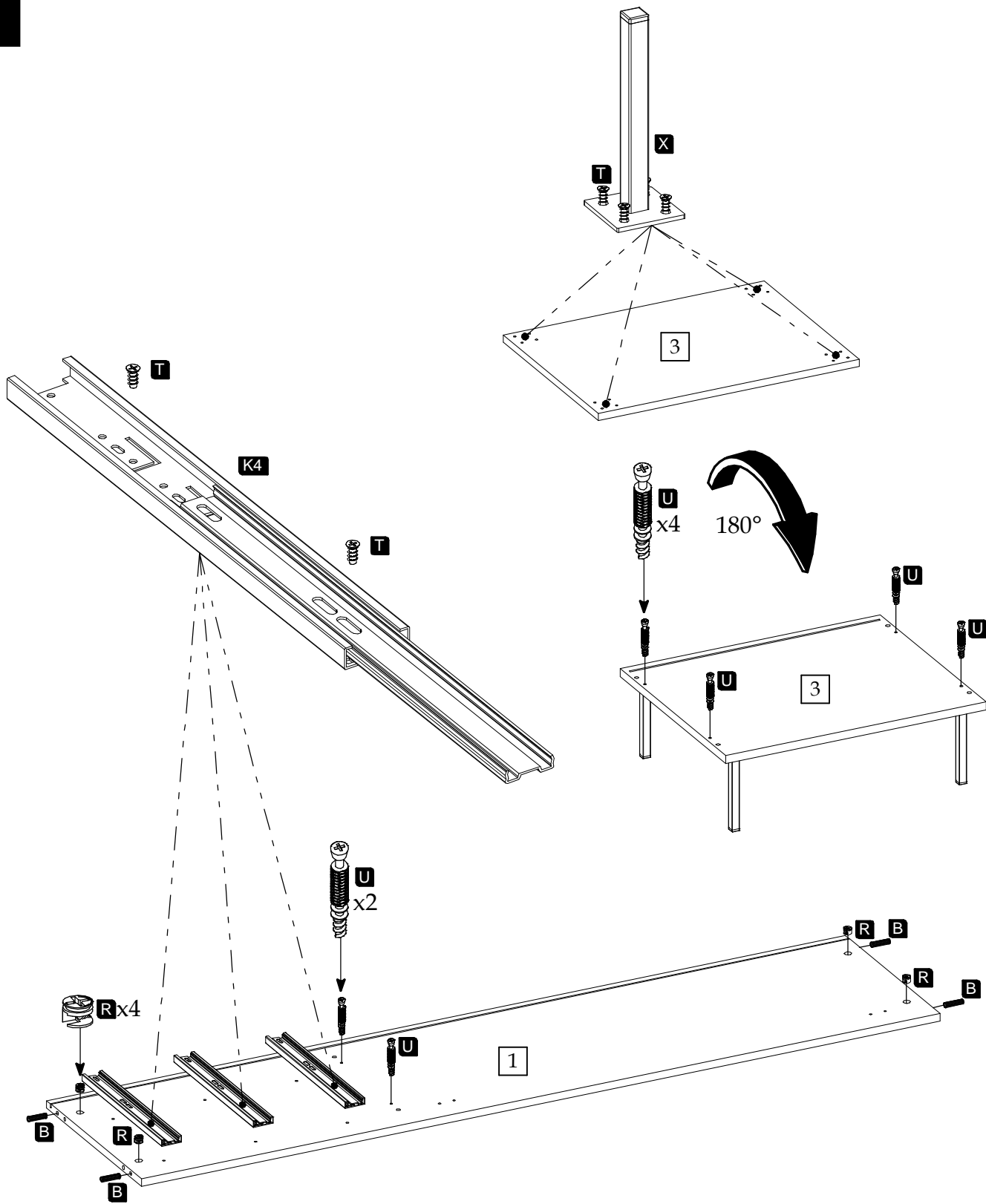

3

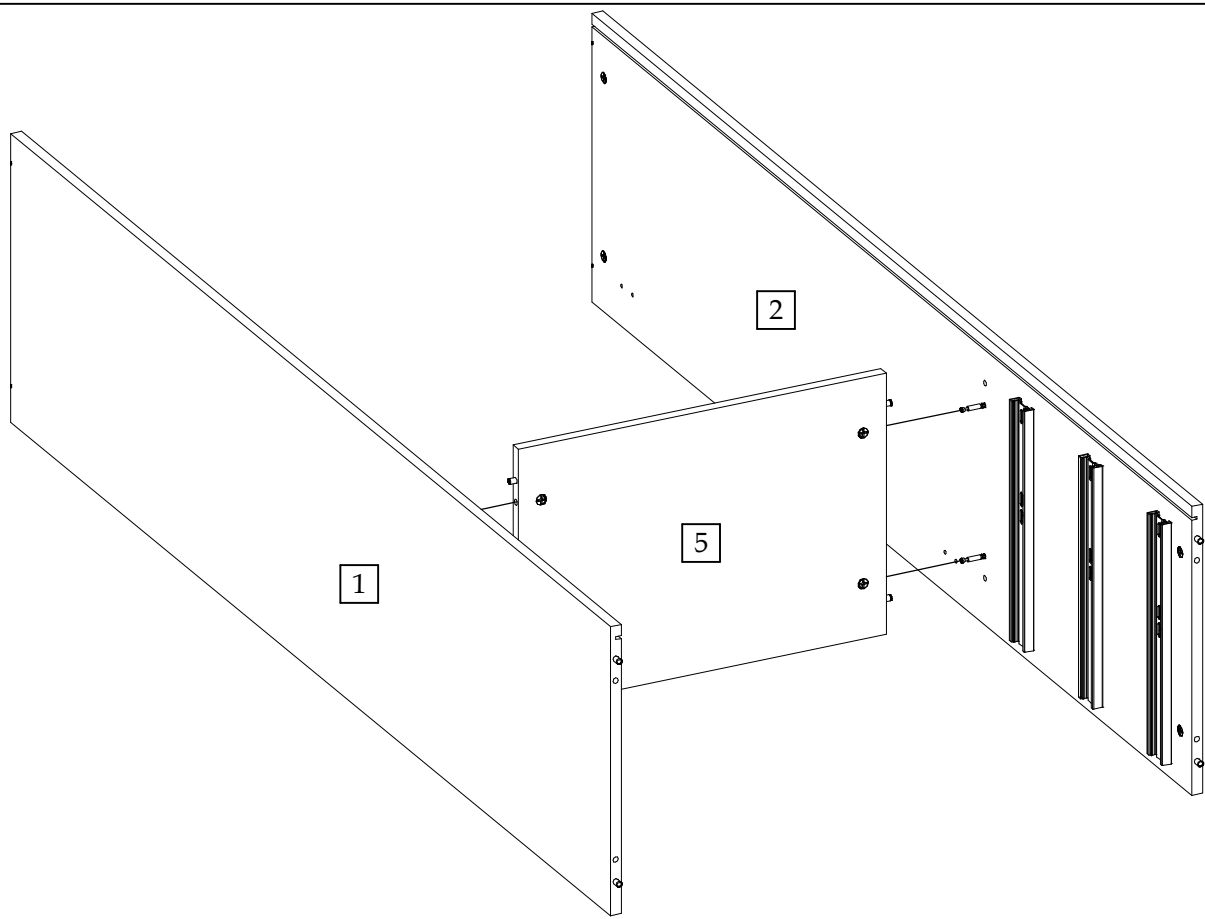

4

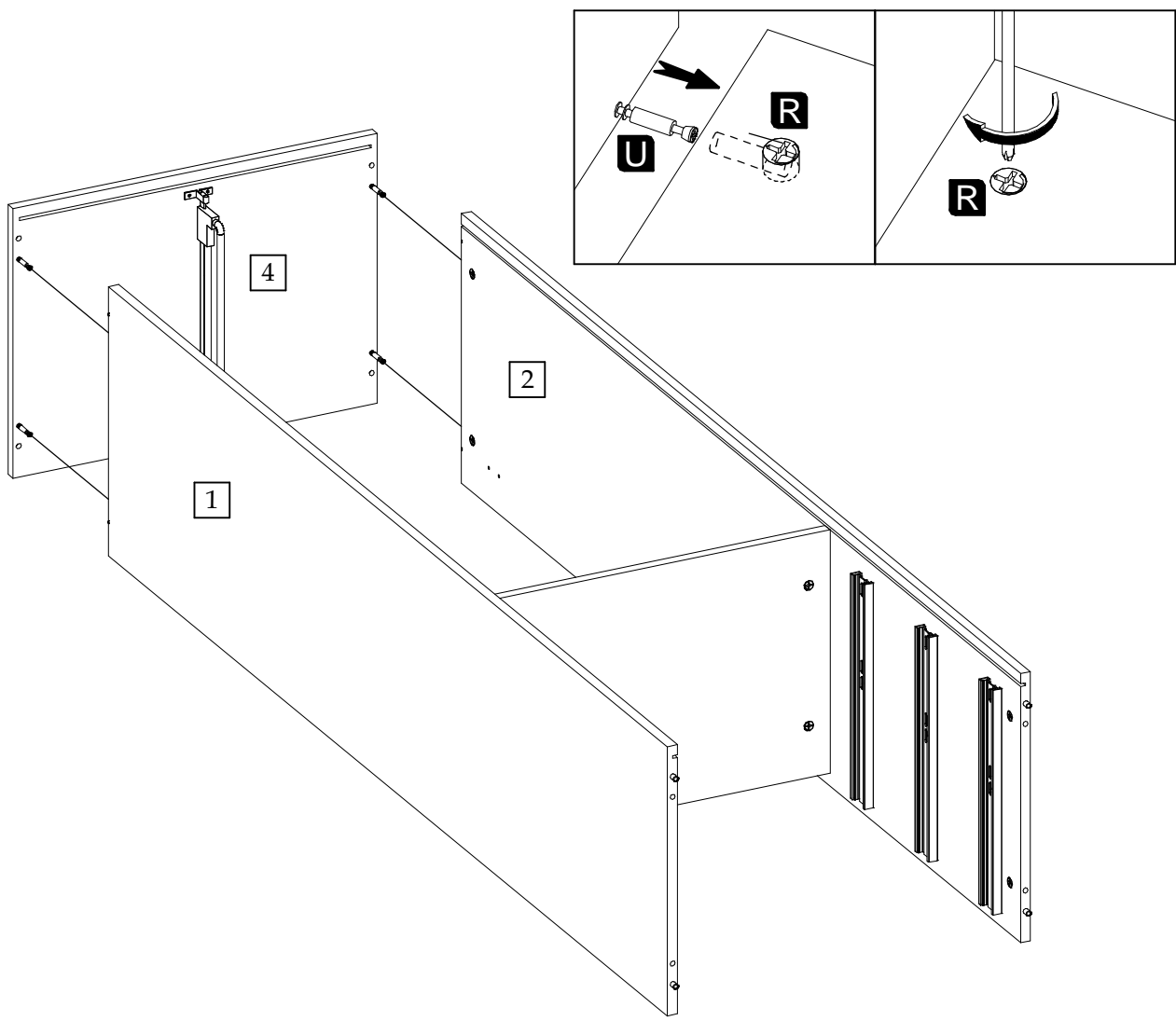

5

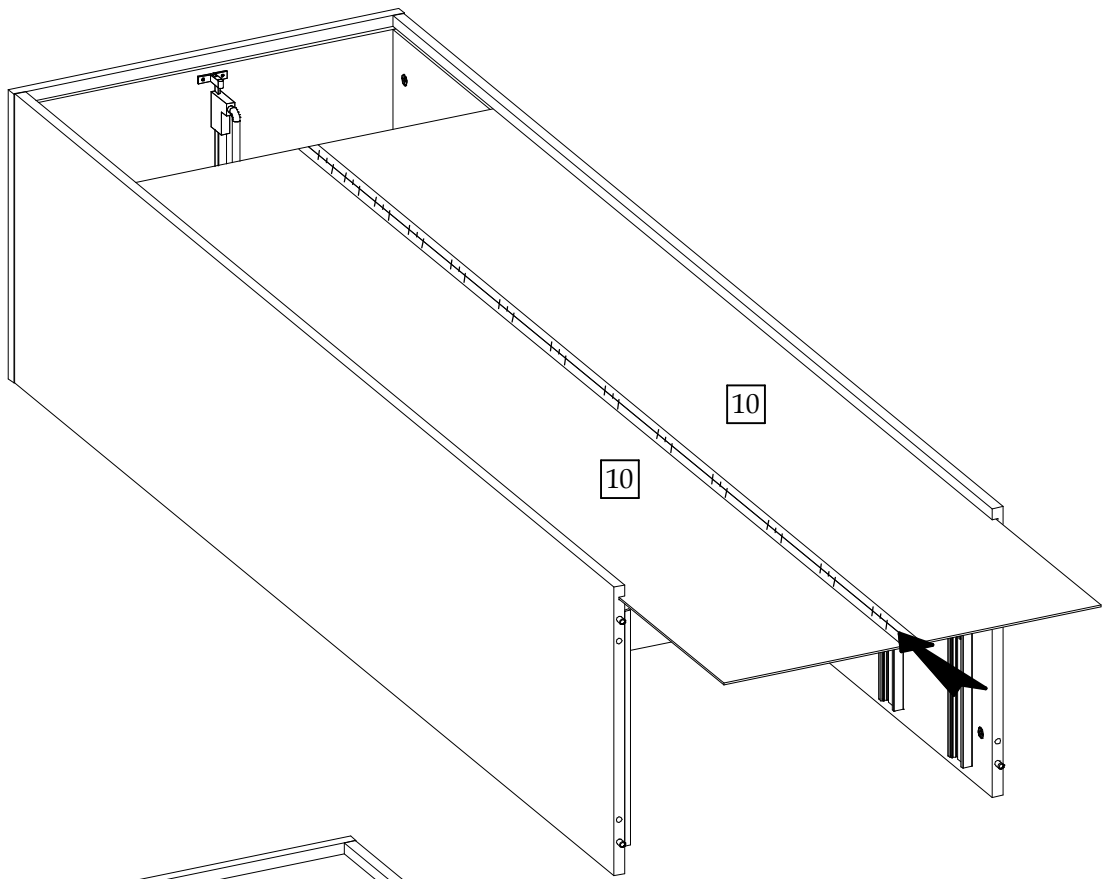

6

