

# LINGO K

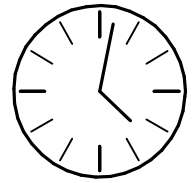

80 min

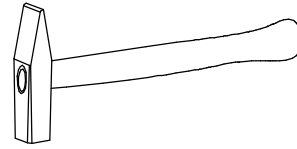

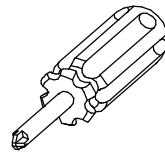
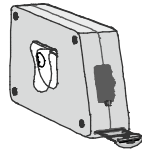
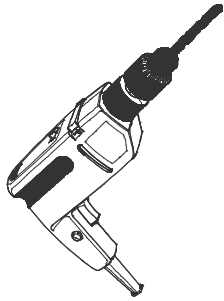
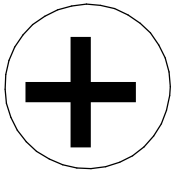
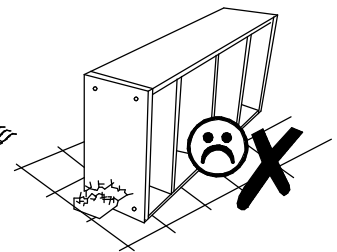
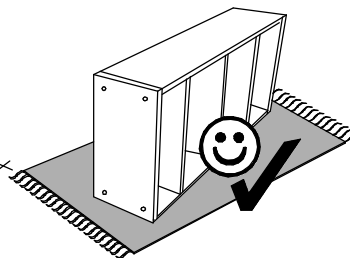
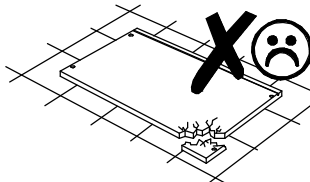
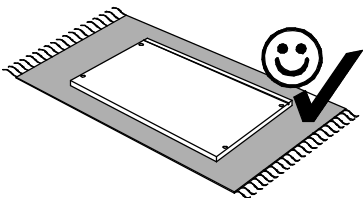
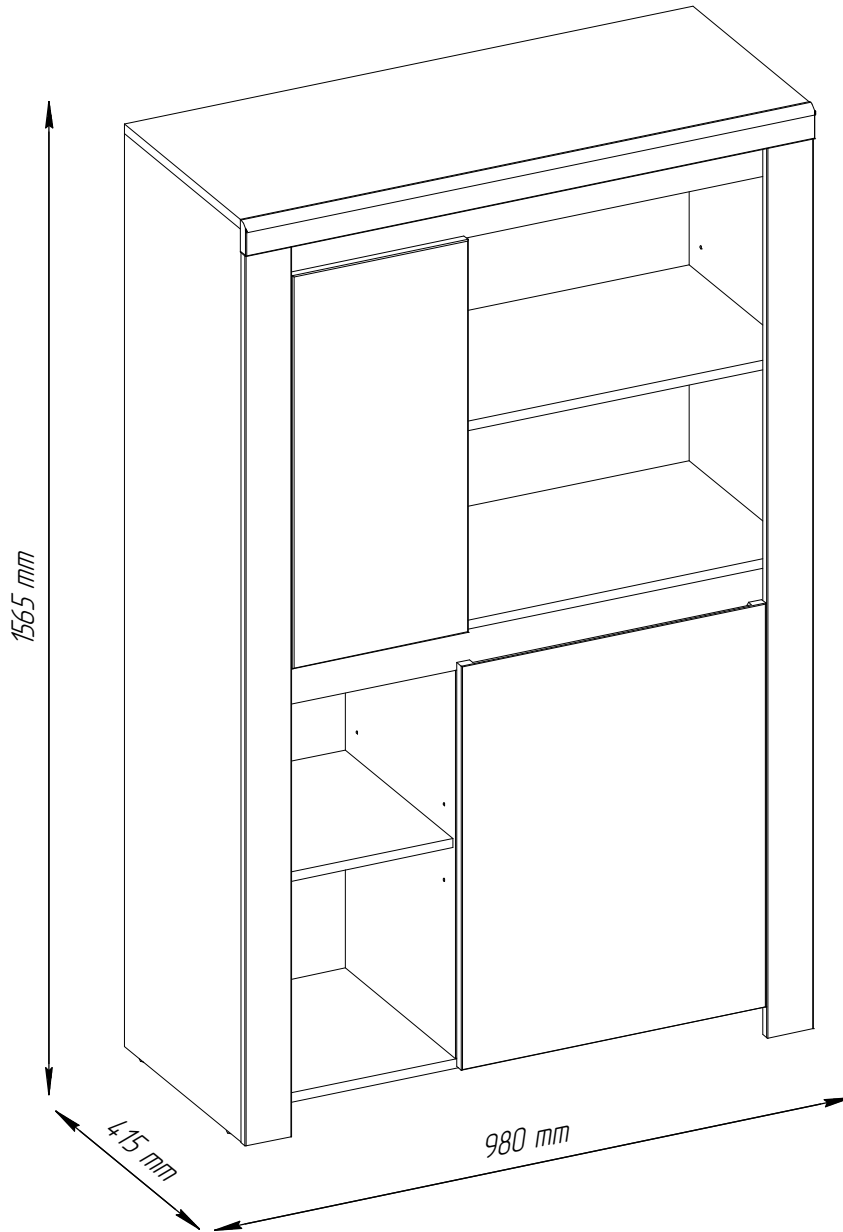
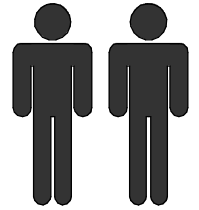
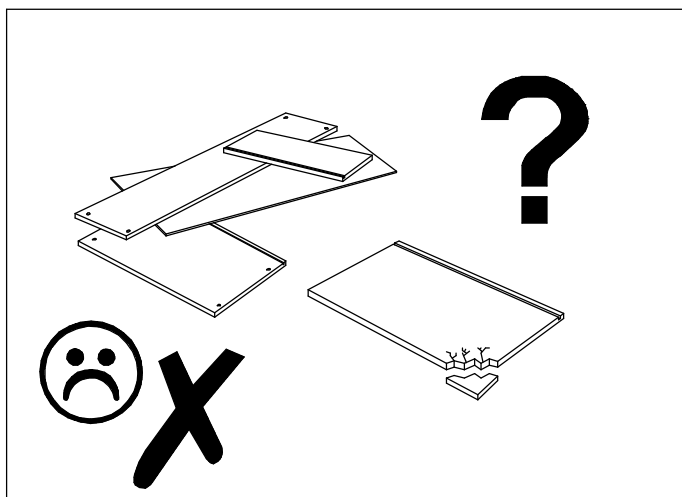
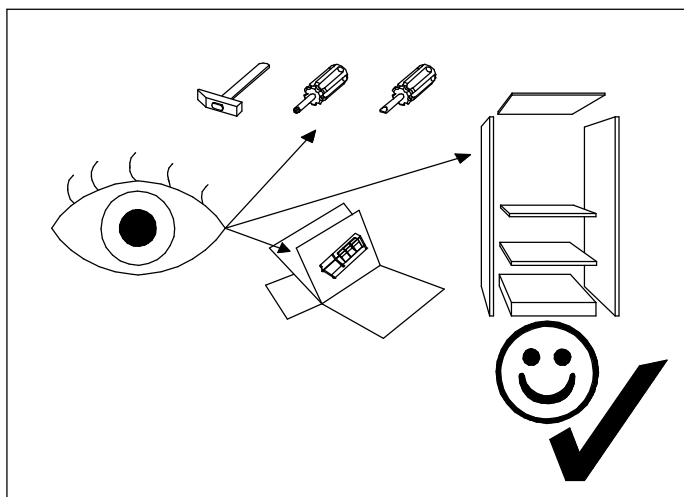
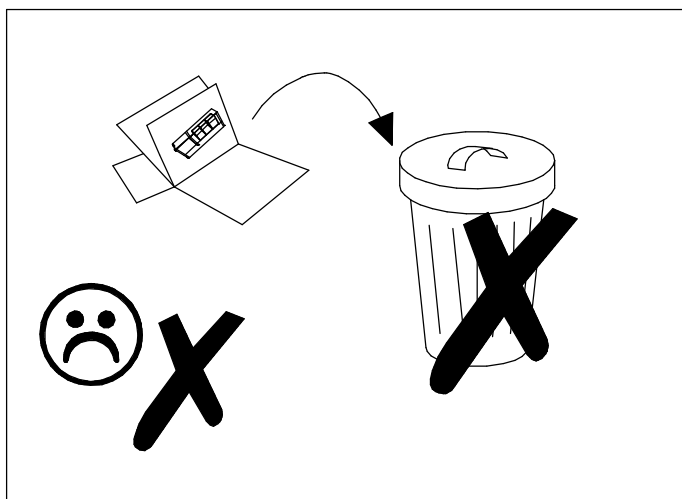
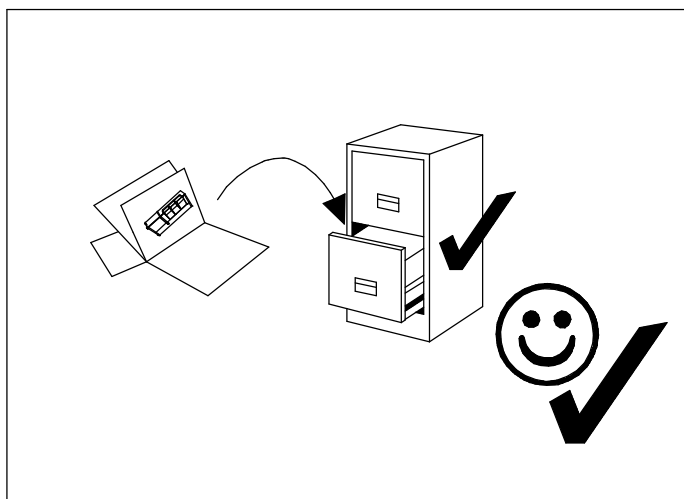
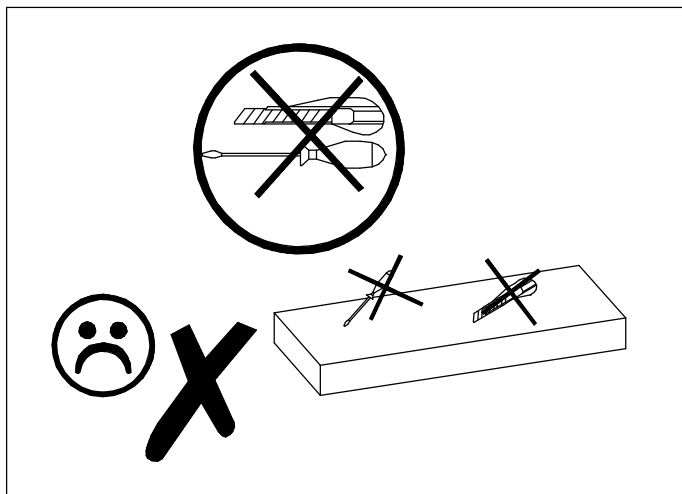
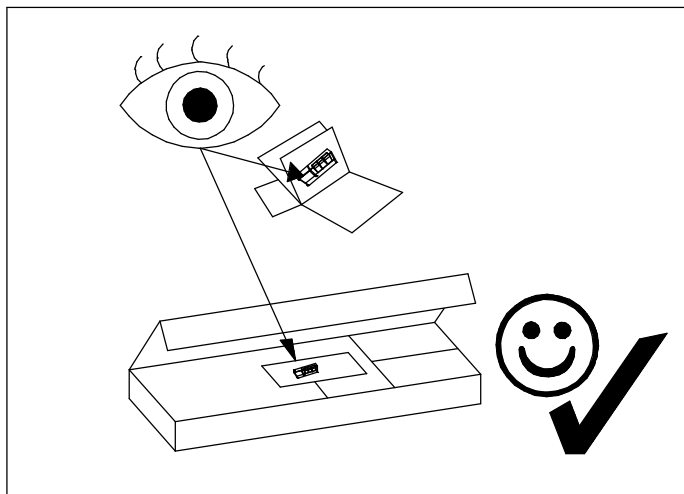

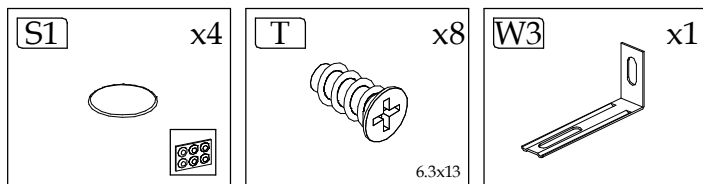
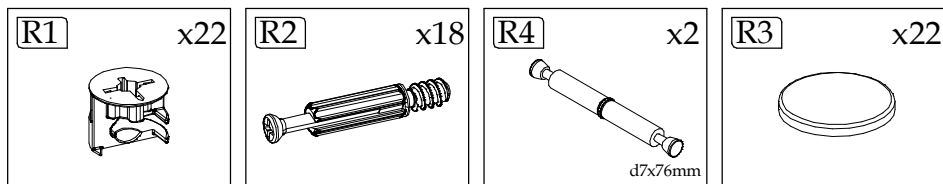
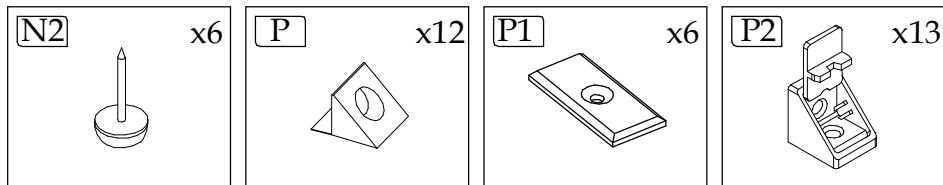
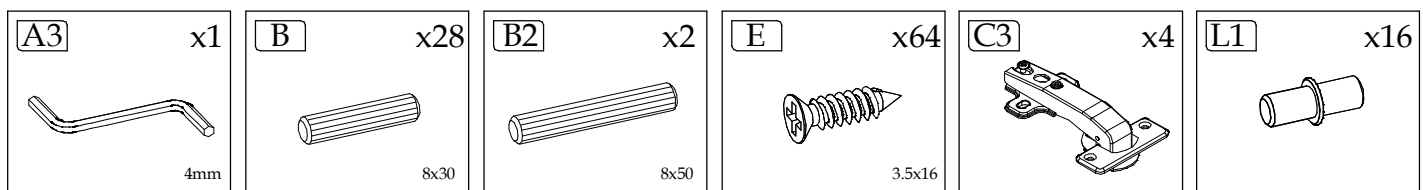

Element symbol	Measurements				Code	Paket
	1	2	3	4		
1	980	399	16	1	1029	1/3
2	1544	399	16	1	1003	2/3
3	1544	399	16	1	1004	2/3
4	740.5	378	16	1	1059_v	1/3
5	721.5	378	16	1	1058_v	1/3
6	946	379	16	1	1030	1/3
7	946	65	16	1	1025	2/3
8	946	65	16	1	1039	2/3
9	946	379	16	1	1005/2005	1/3
10	250	50	16	1	1061	2/3
11	354	369	16	1	N/A	1/3
12	354	369	16	1	N/A	1/3
13	576	369	16	1	N/A	2/3
14	576	369	16	1	N/A	2/3
15	1499	369	3	1	N/A	2/3
16	1499	295	3	2	1060_v	2/3
17	666	304	16	1	1038/3001	3/3
18	685	526	16	1	1039/3002	3/3
19	1507	82	16	1	1017/3003	2/3
20	1507	82	16	1	1017/3004	2/3
21	982	56.5	19	1	1018/3005	1/3

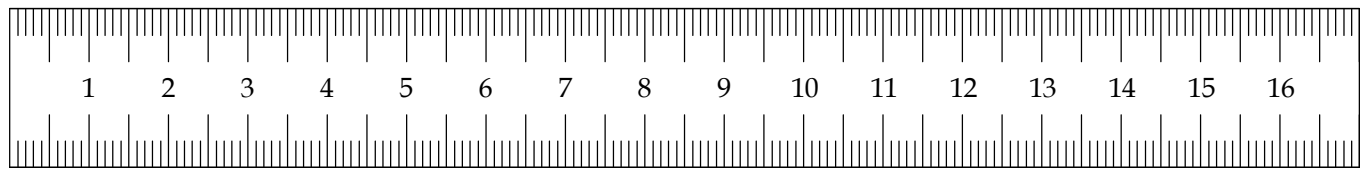
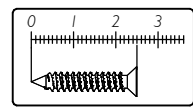
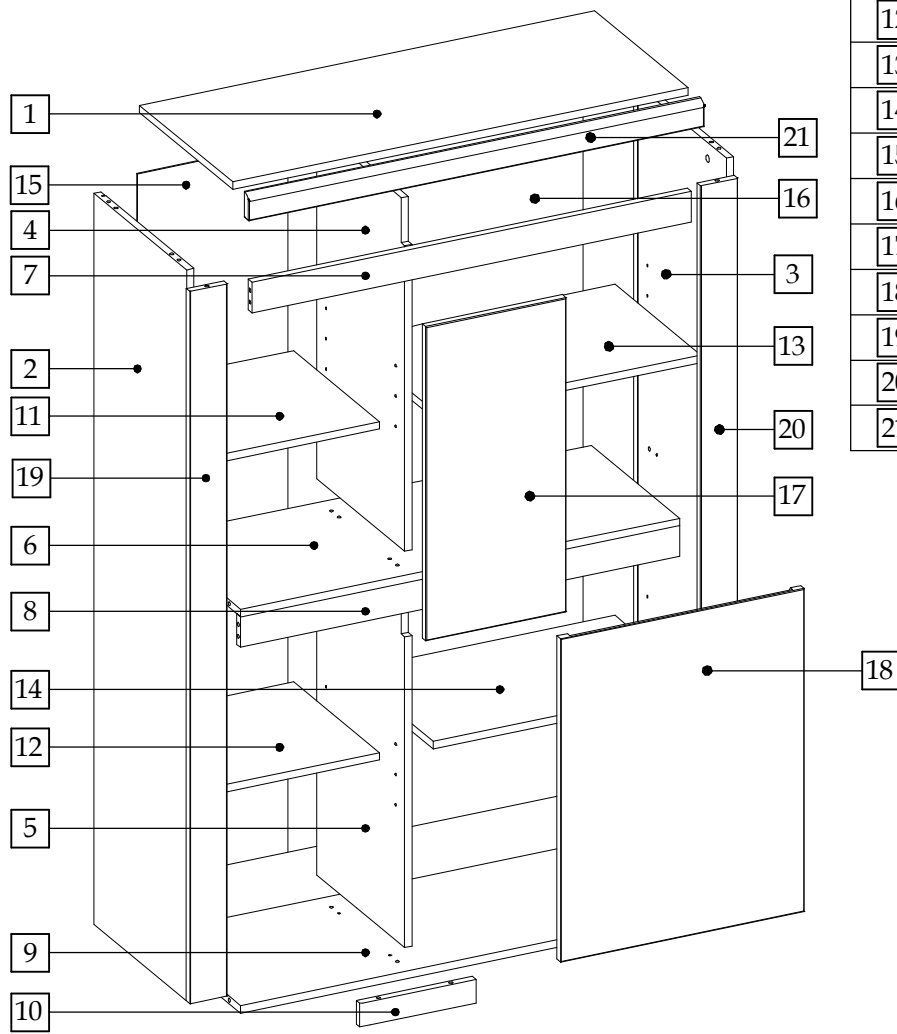



▶ 2

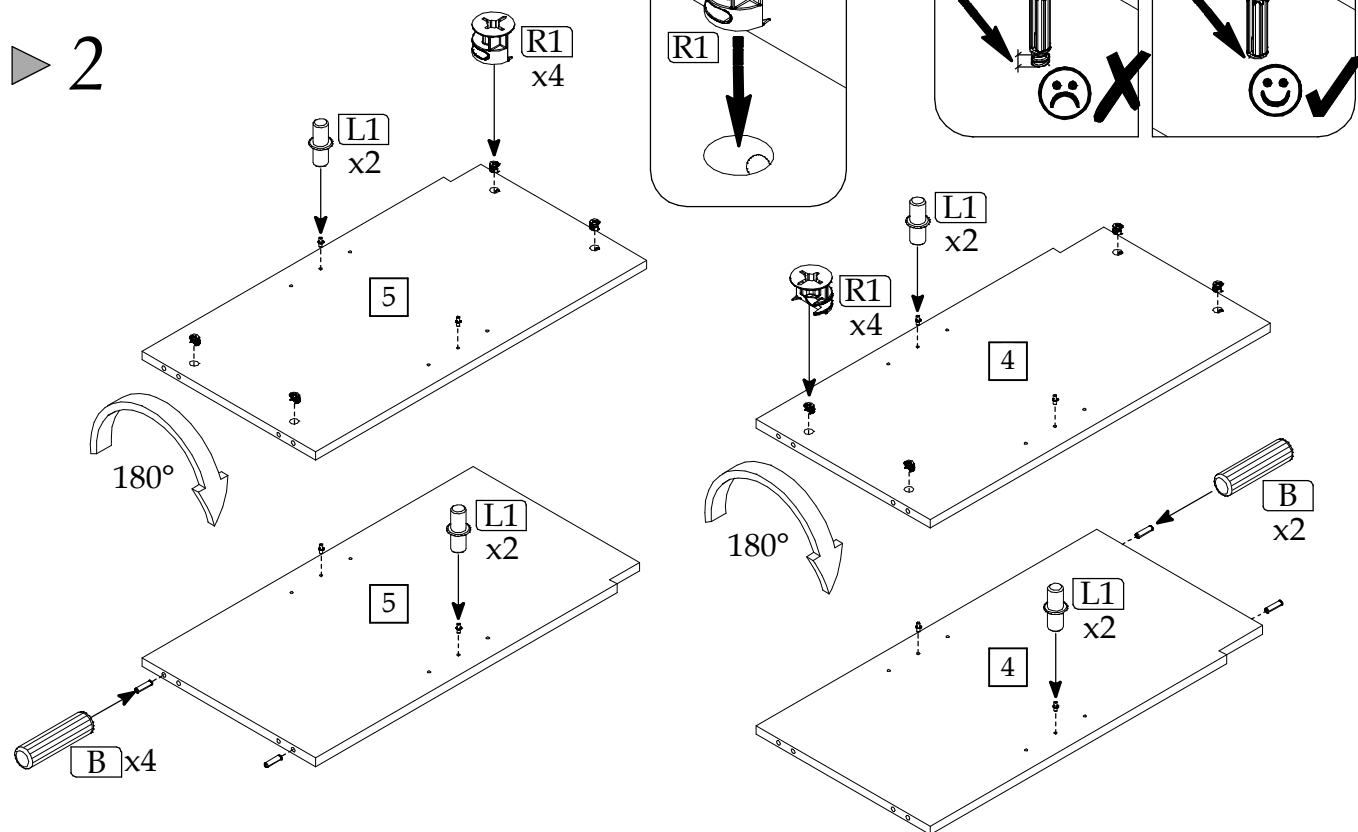

▶ 3

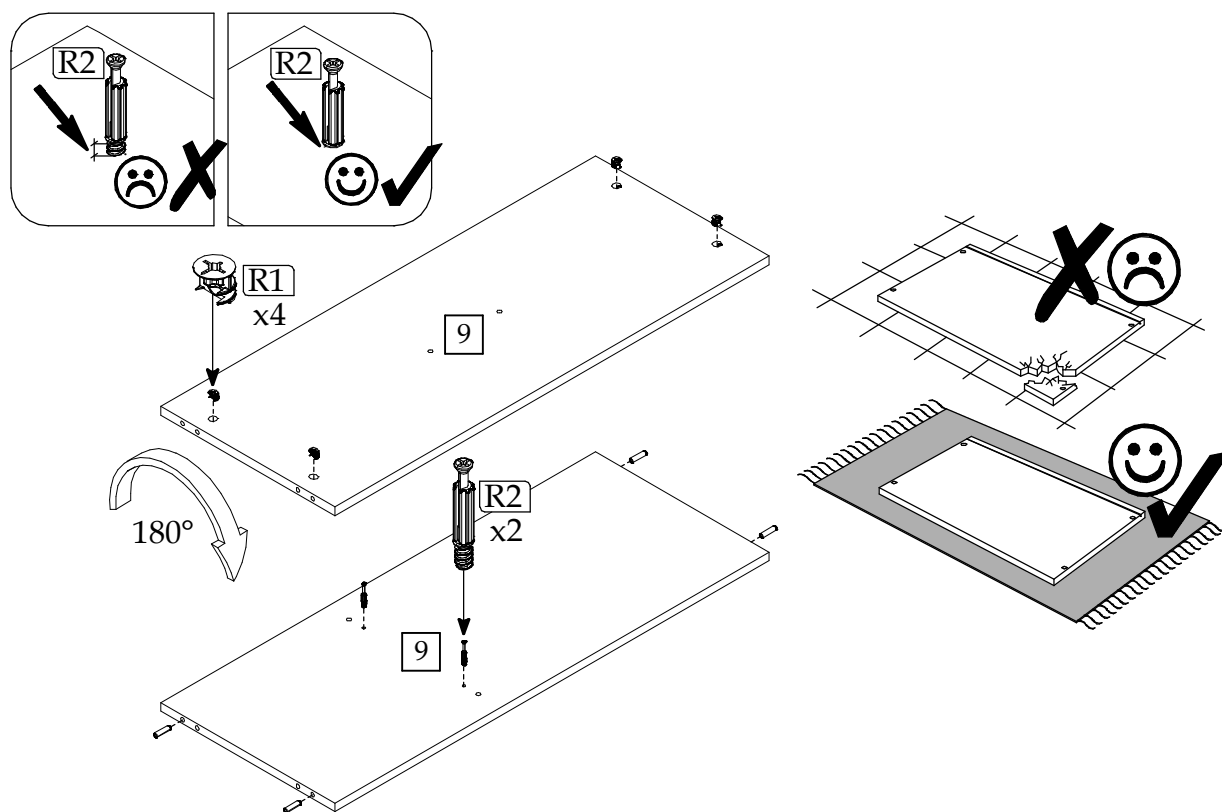

▶ 4

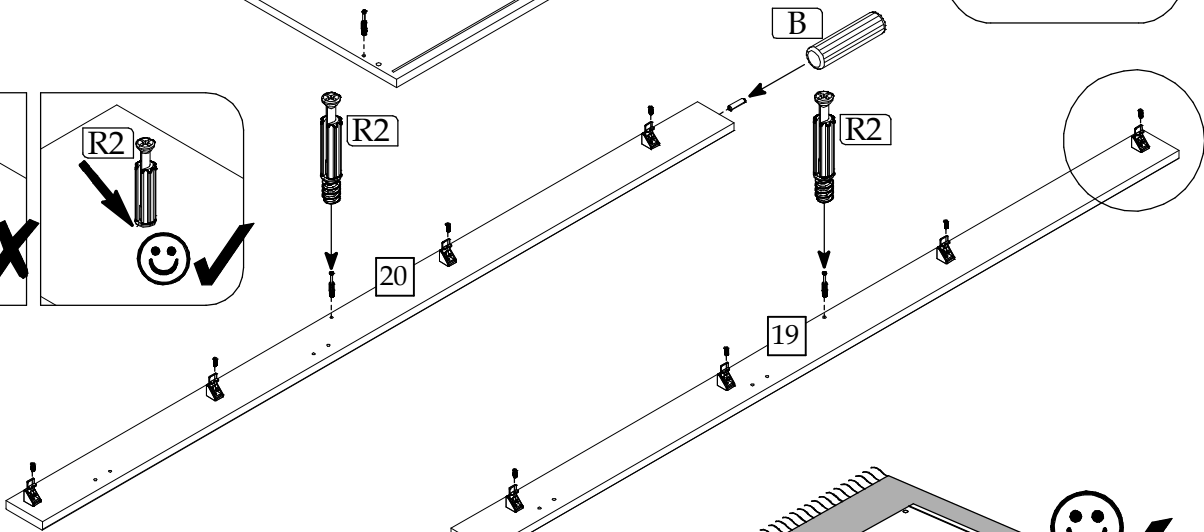
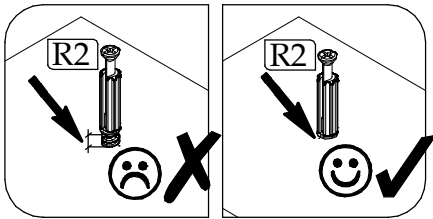
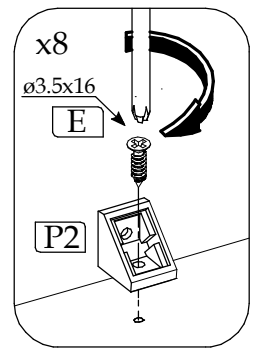
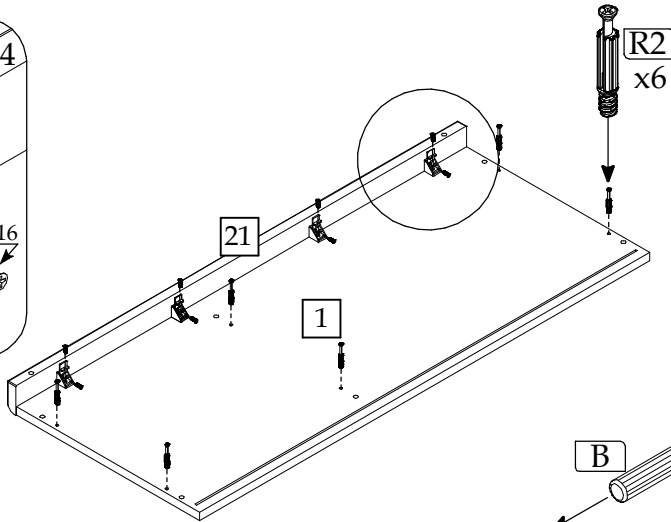
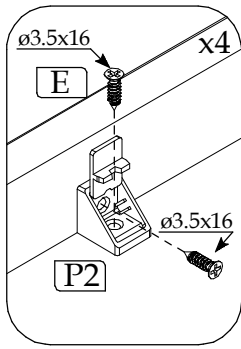

▶ 5

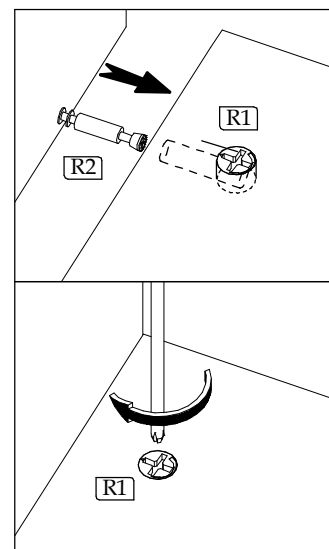
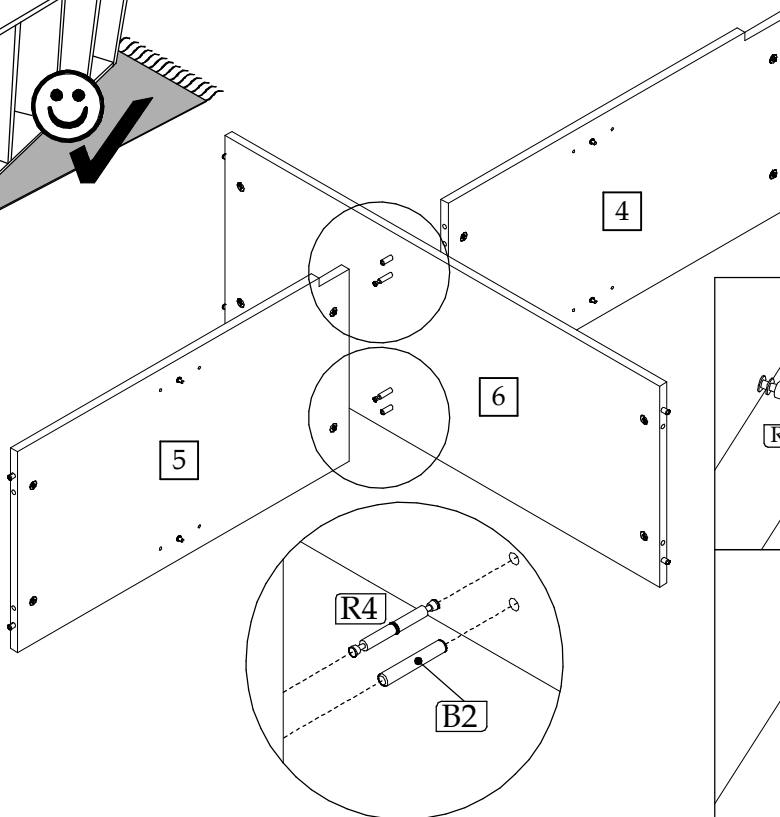
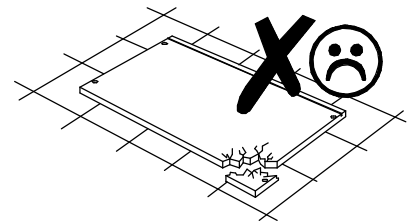
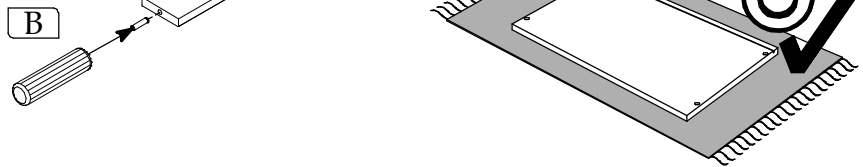
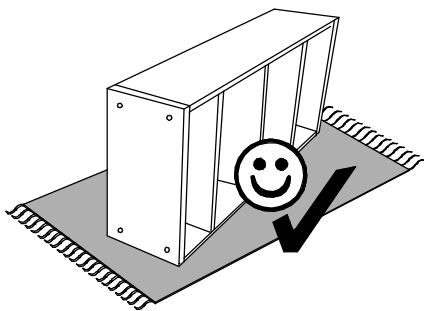

▶ 6

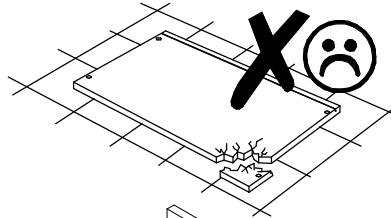
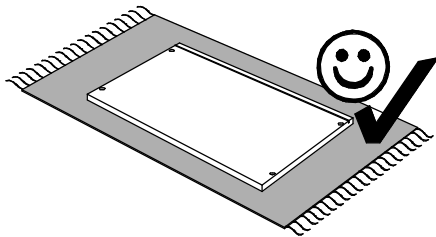
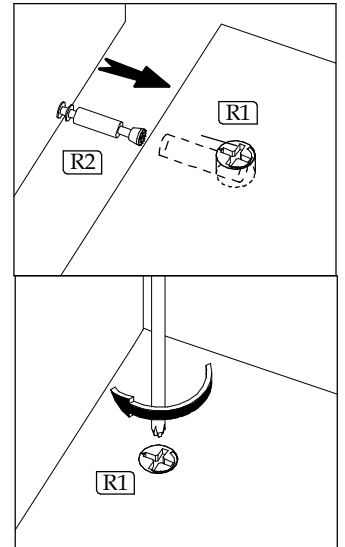
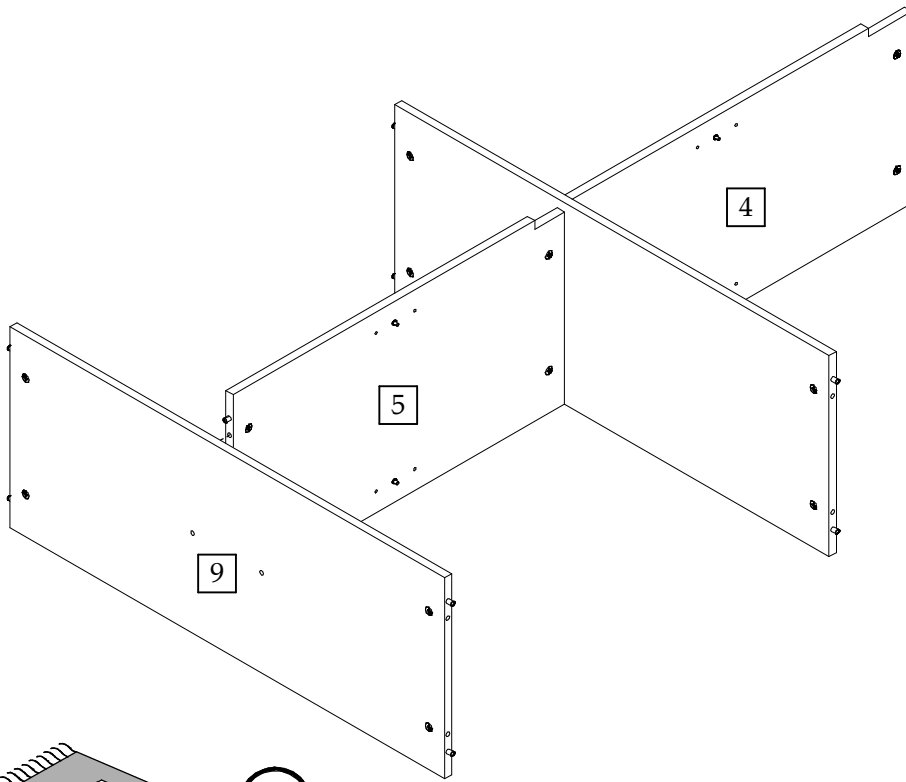

▶ 7

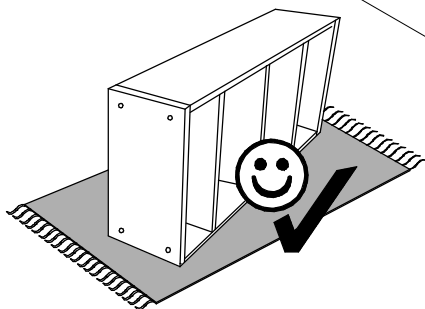
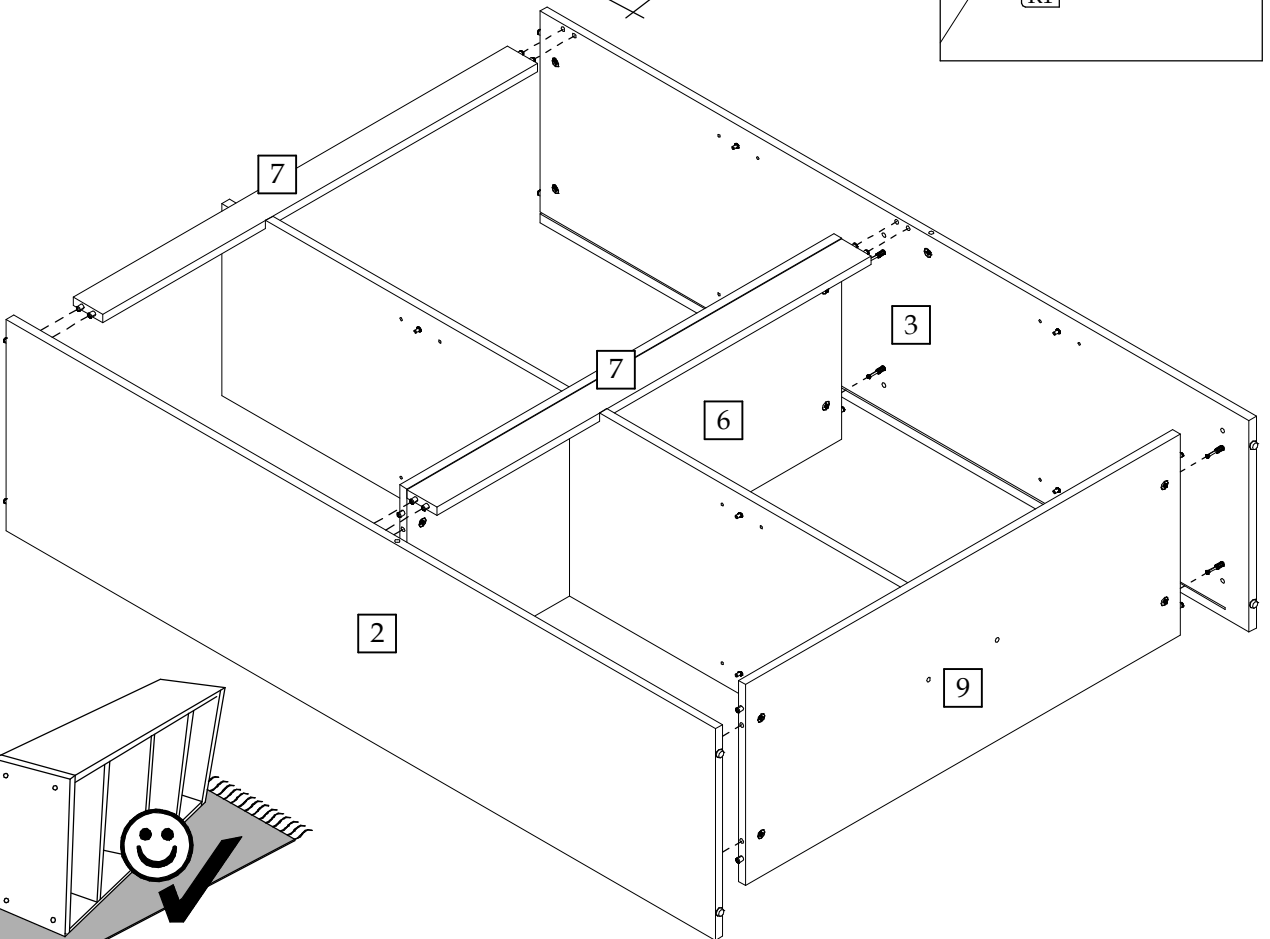

▶ 8

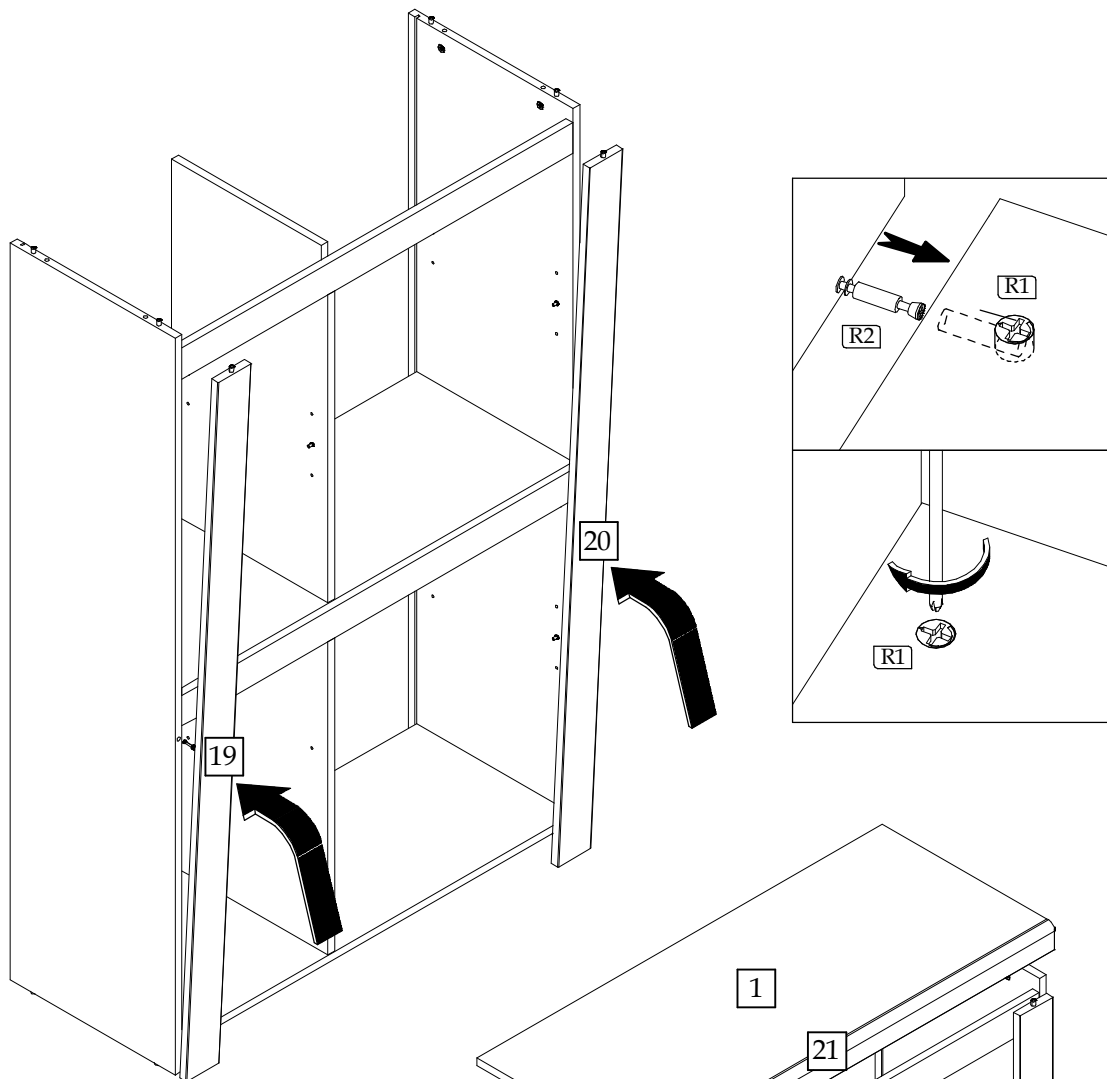

▶ 9

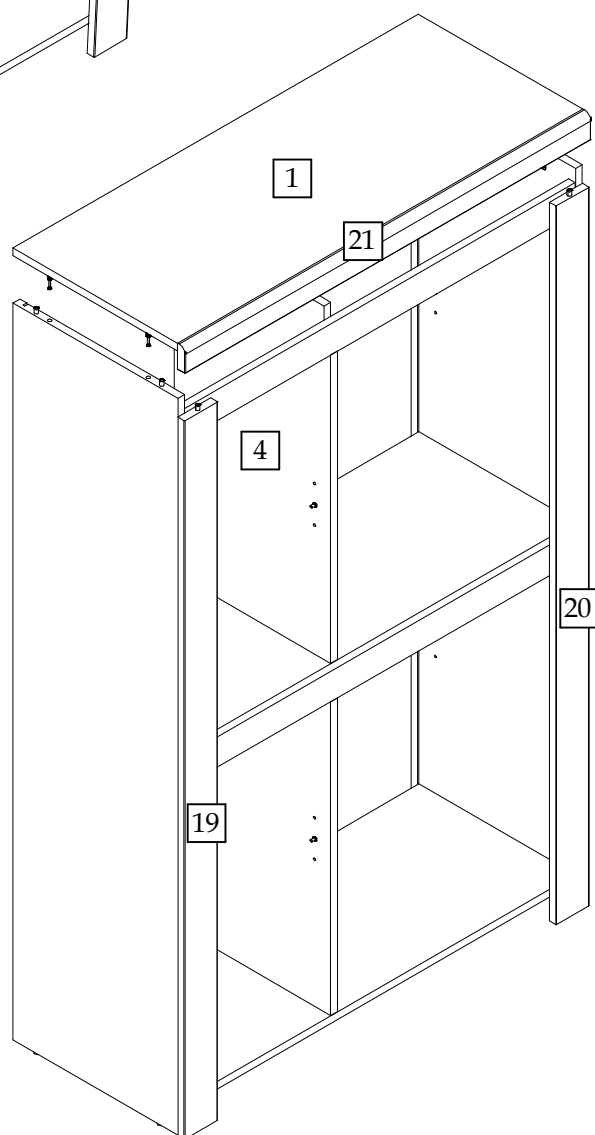
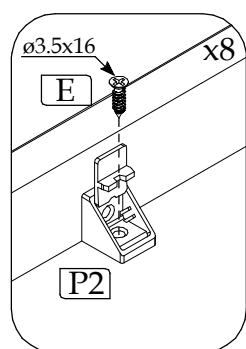



► 10

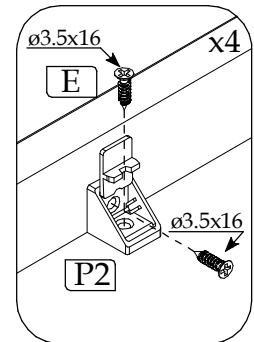
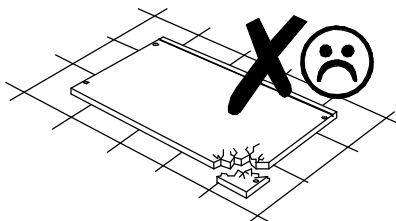
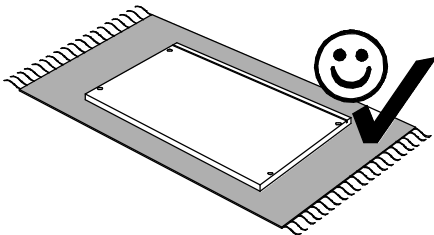
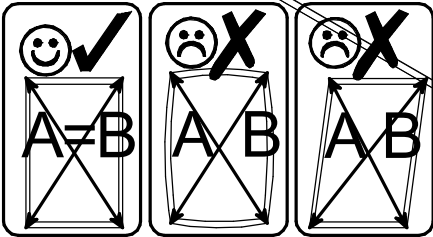
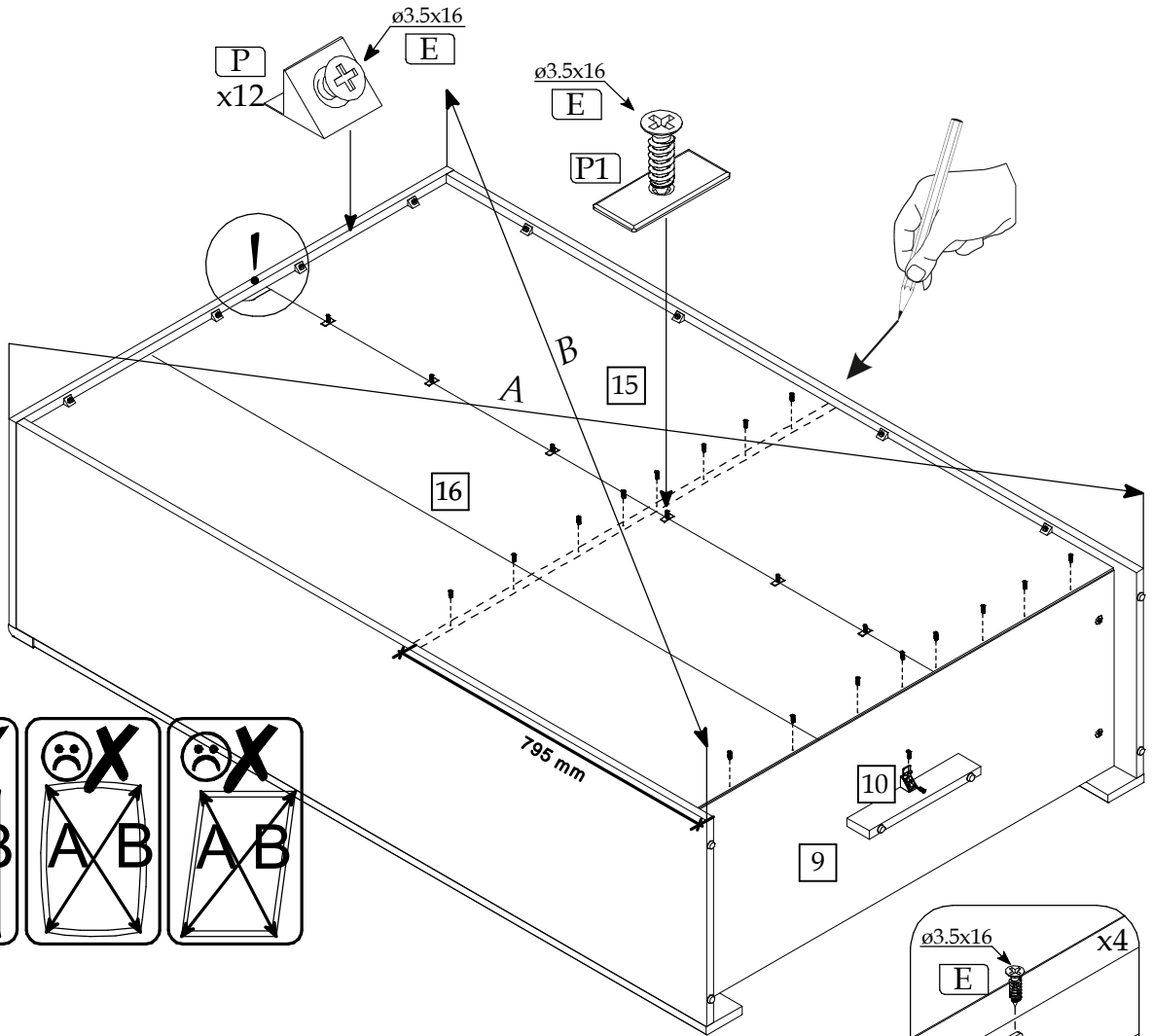
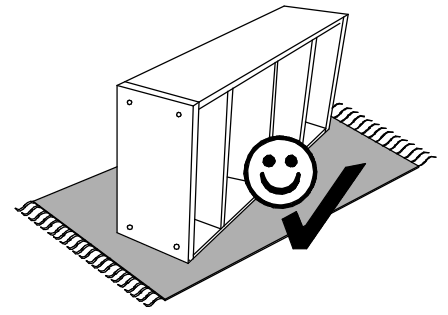

▶ 11

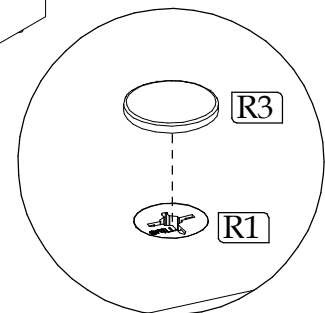
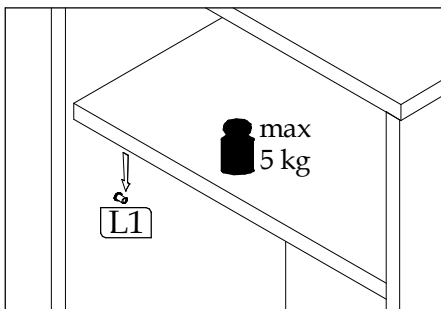
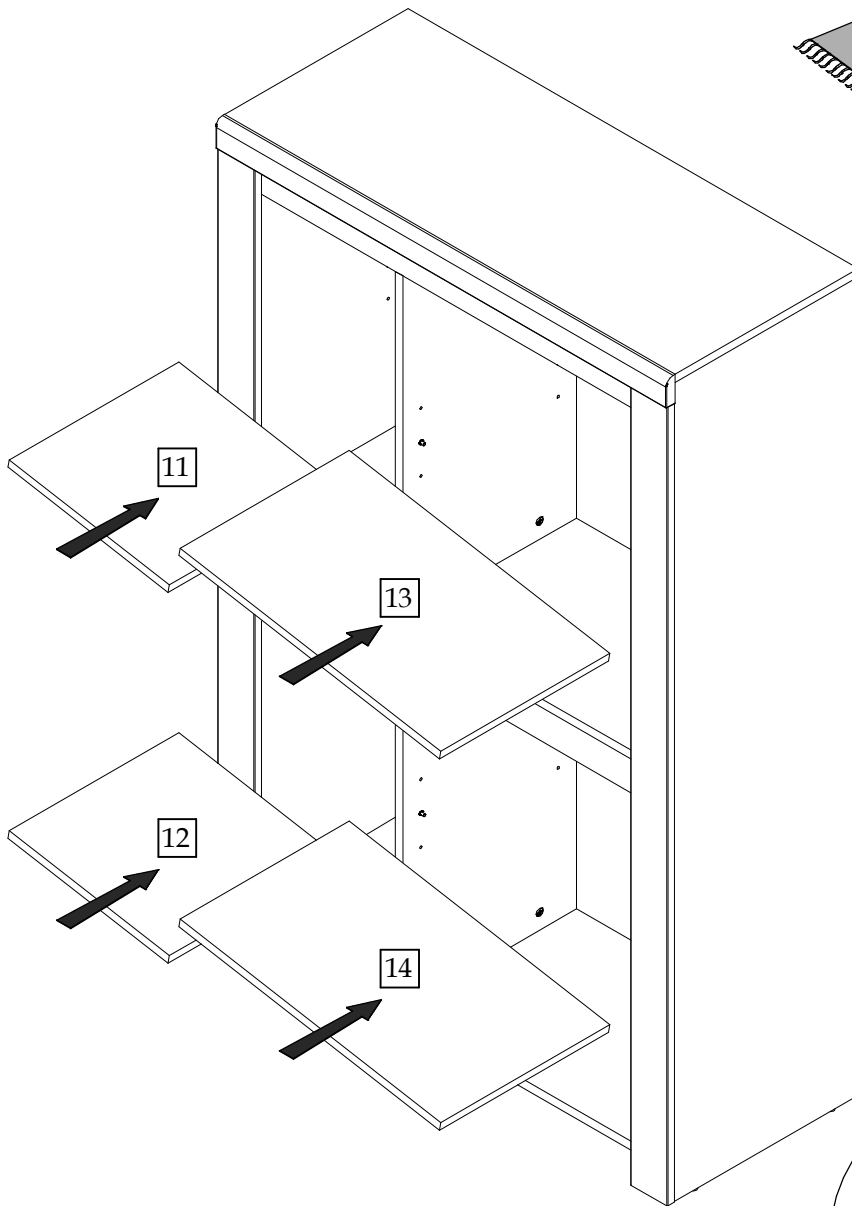
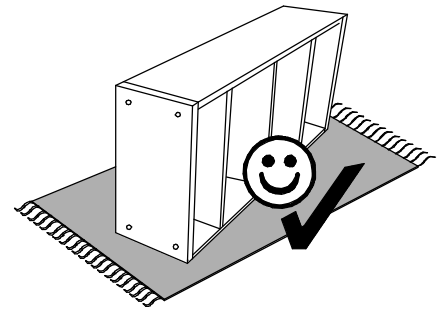

▶ 12

