

LEEDS D

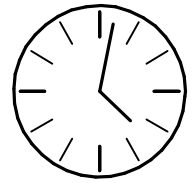

20 min

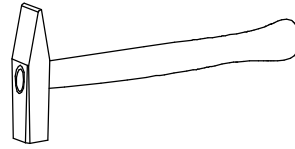

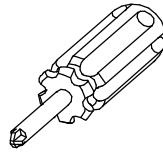
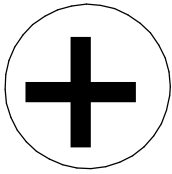
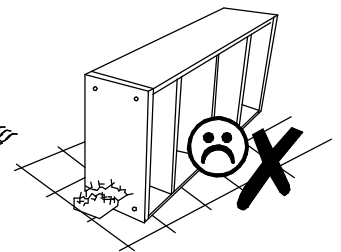
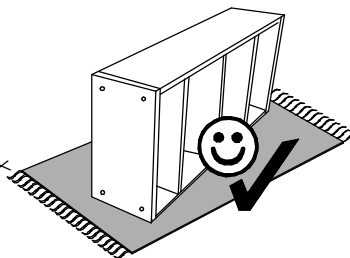
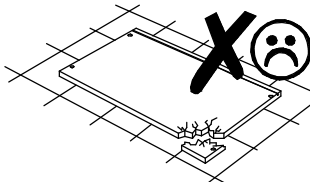
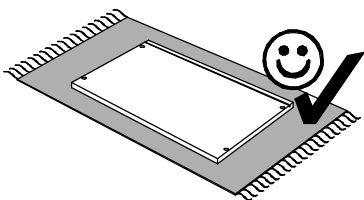
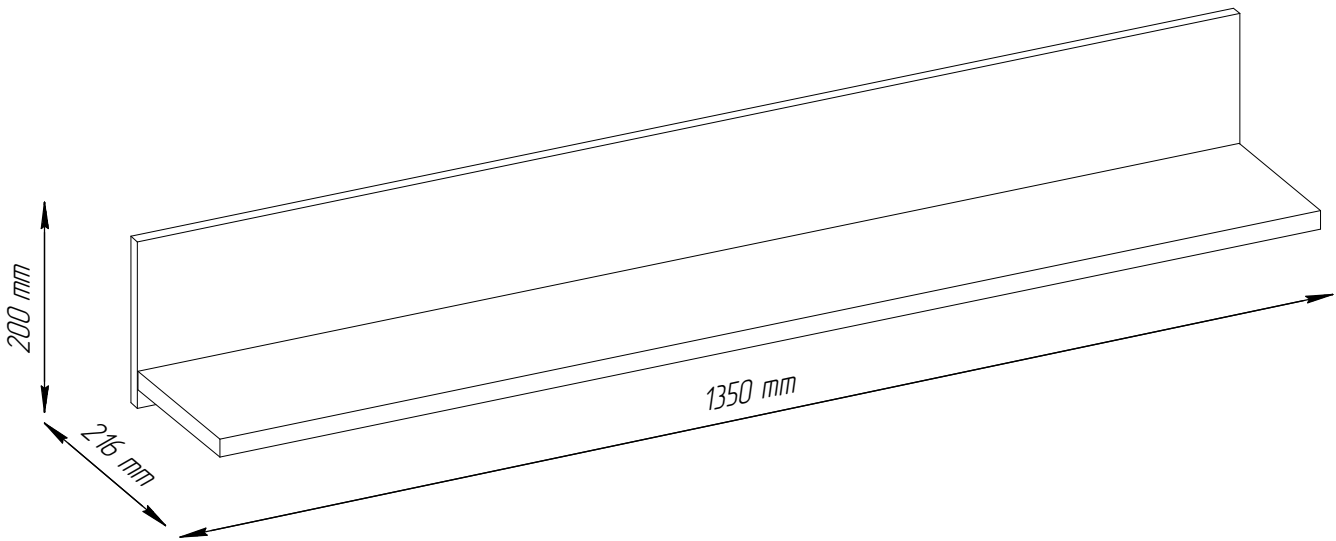
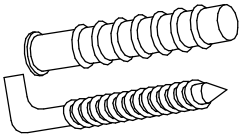
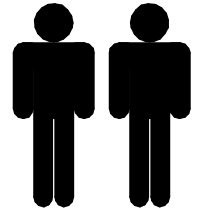
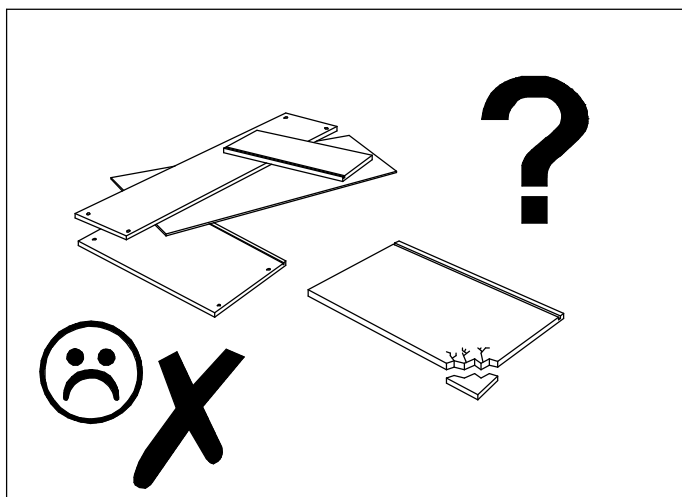
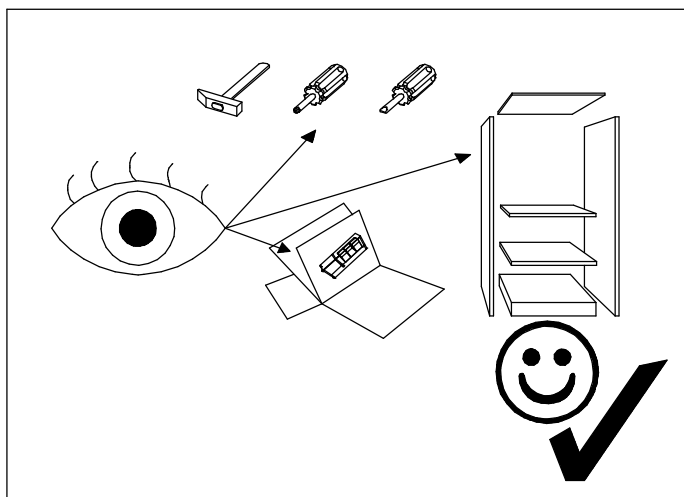
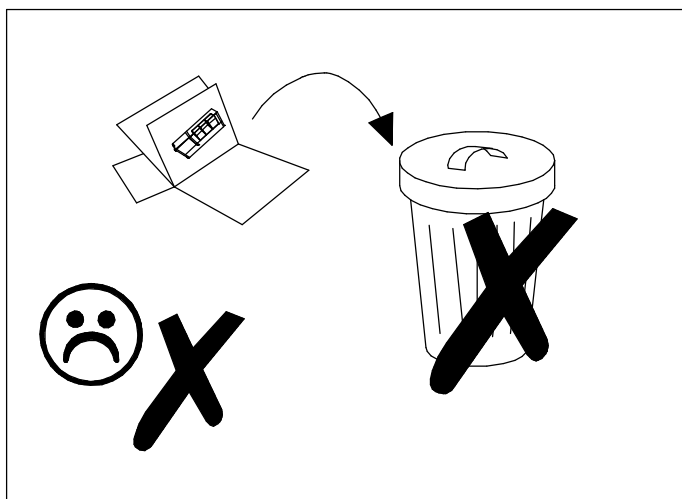
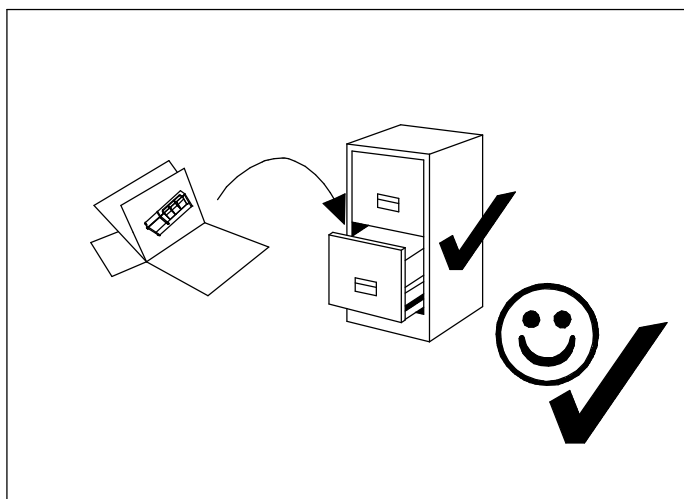

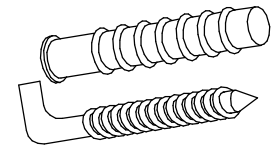
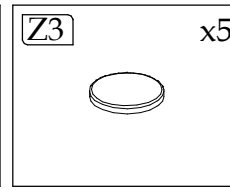
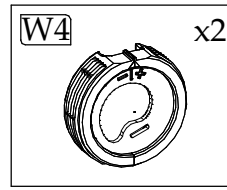
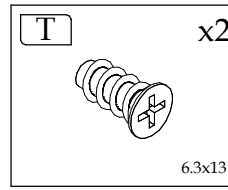
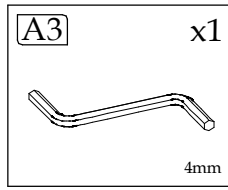
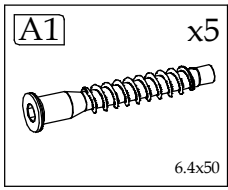

| Element symbol | Measurements | | | | Code | Pack |
|----------------|--------------|-----|----|---|------|------|
| 1 | 1350 | 200 | 16 | 1 | 1001 | 1/1 |
| 2 | 13486 | 200 | 16 | 1 | 1002 | 1/1 |

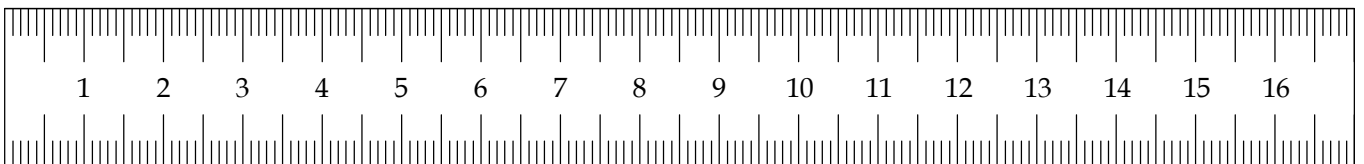
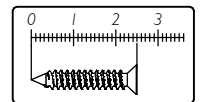
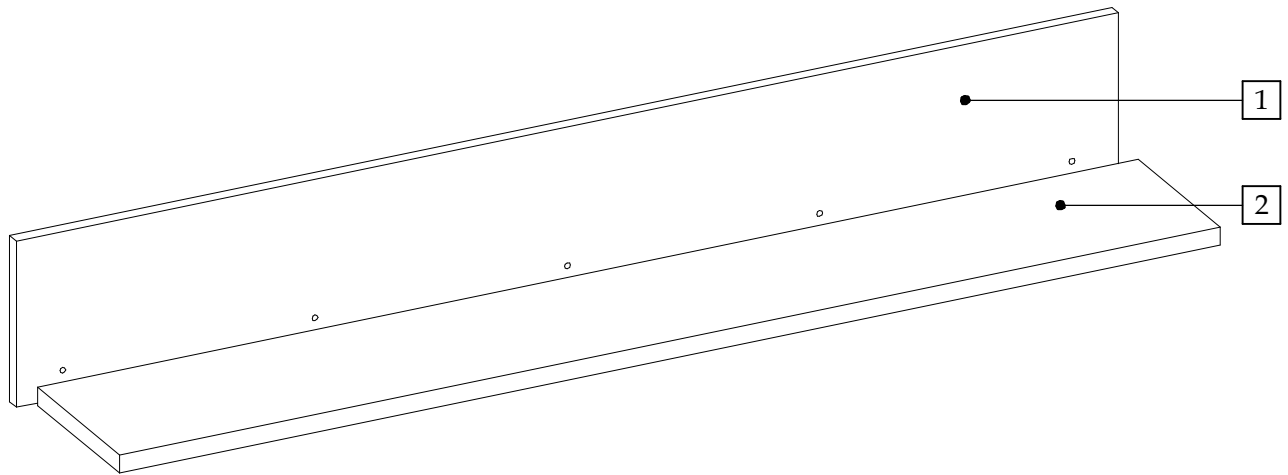

▶ 1

ø6.3x13
T x2

±3mm

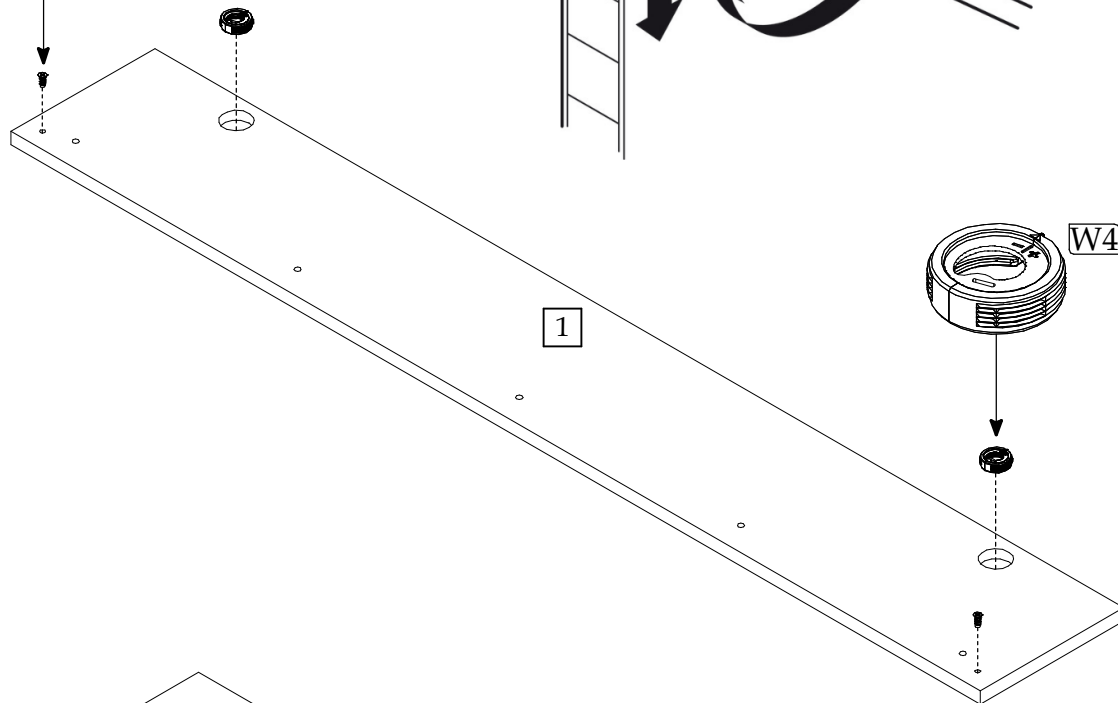

▶ 2

Z3

A3

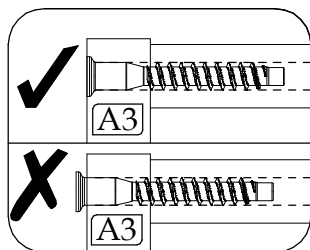

A3

A1 x5

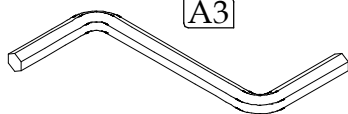

► 3

