

LINGO

Typ C

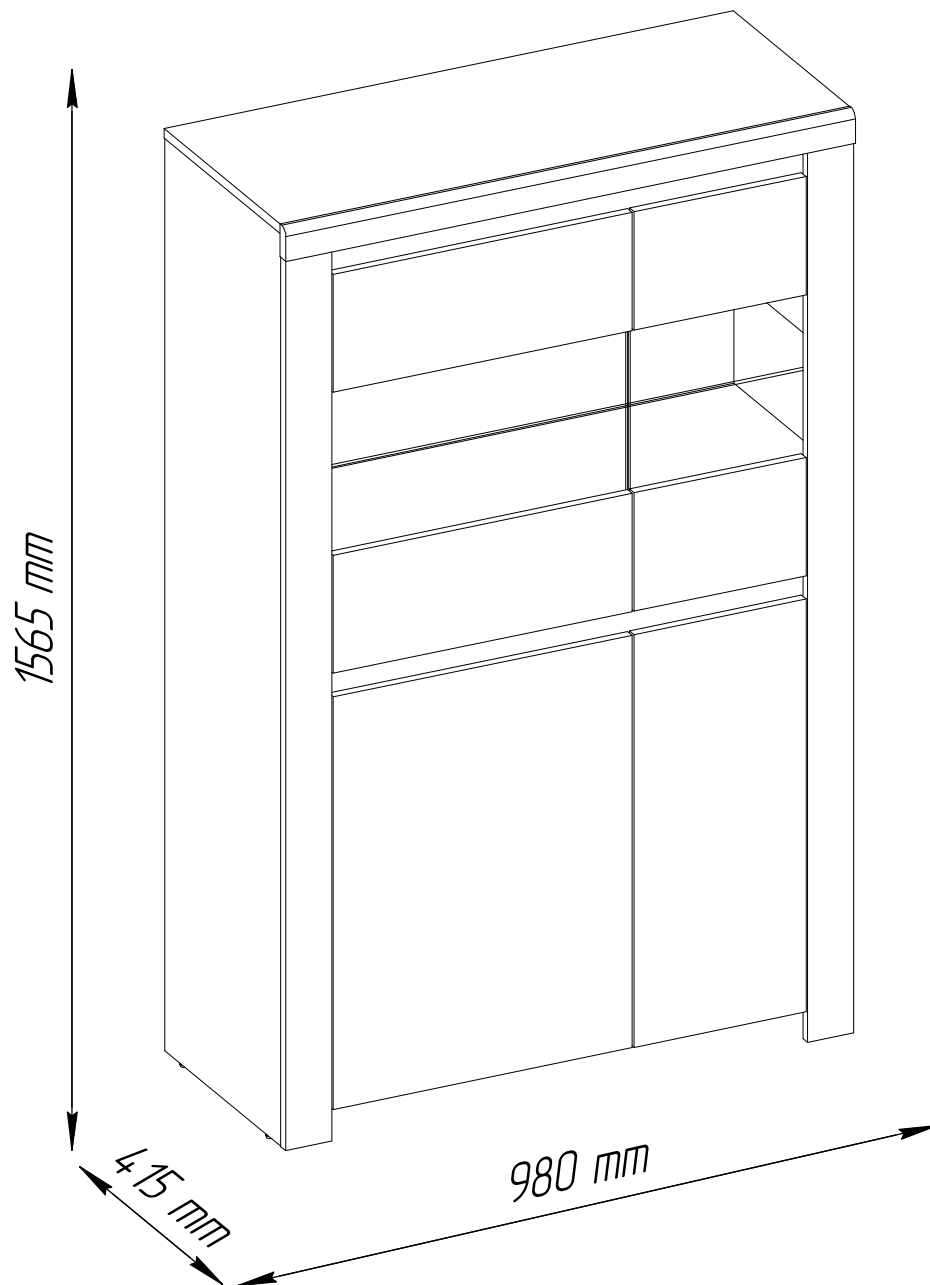

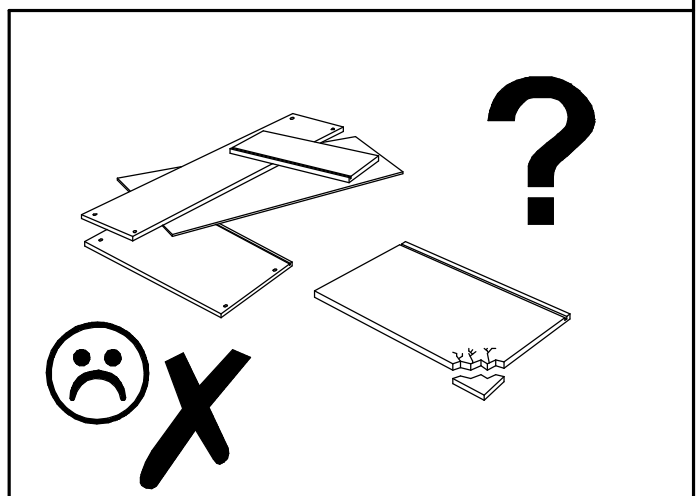

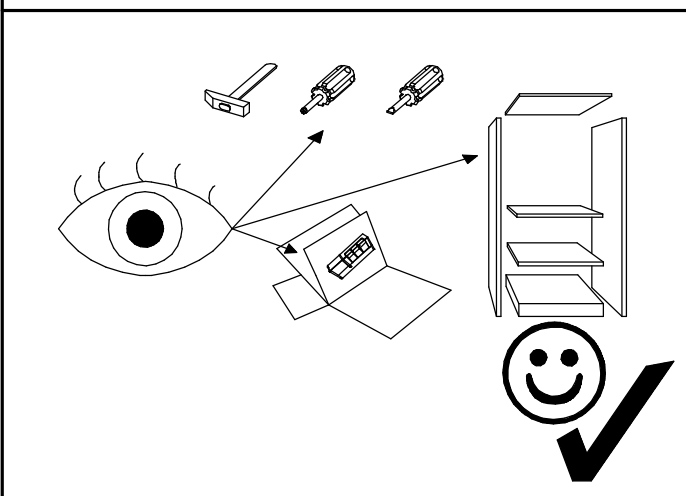
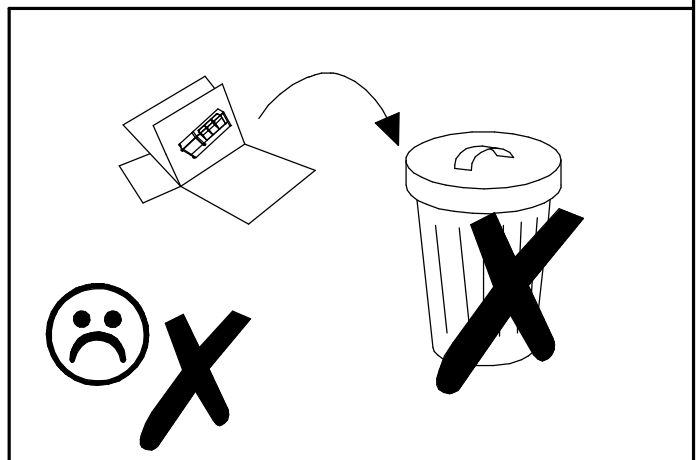
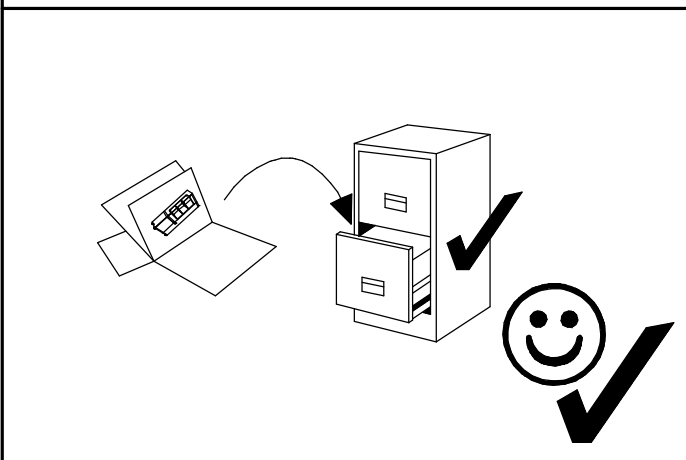
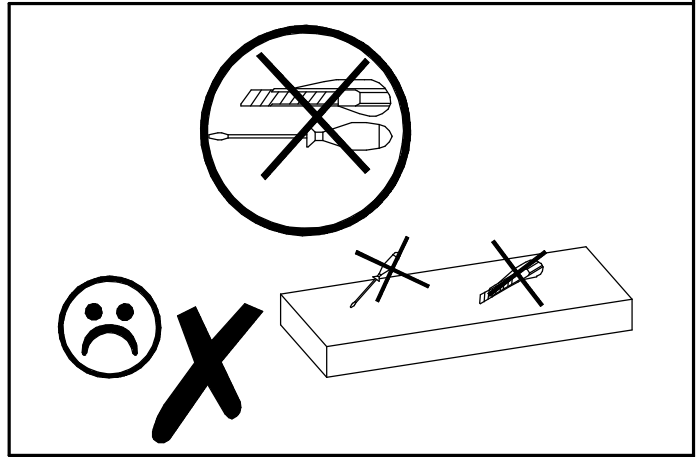
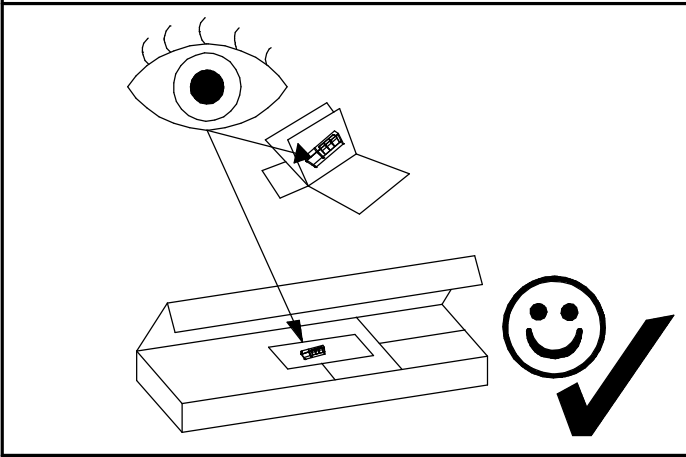
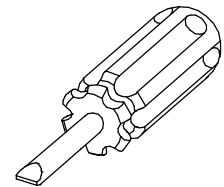
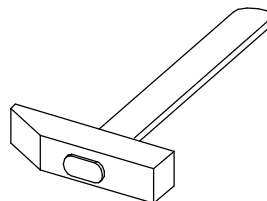
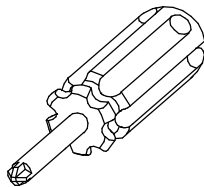
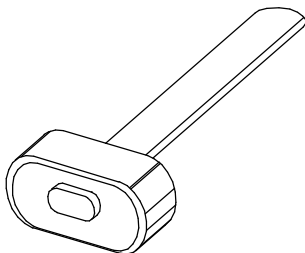
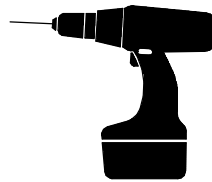
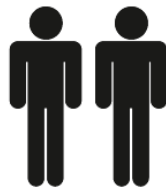
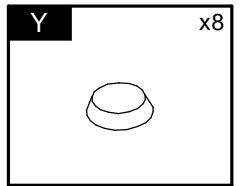
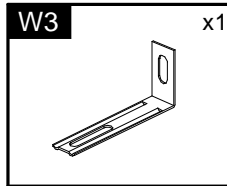
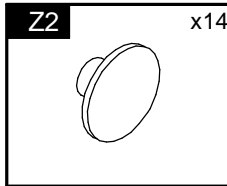
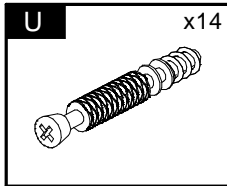
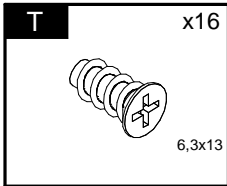
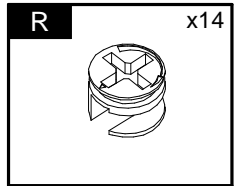
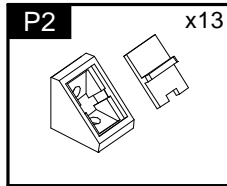
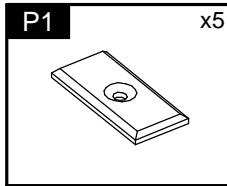
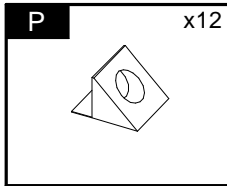
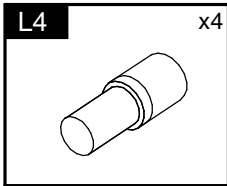
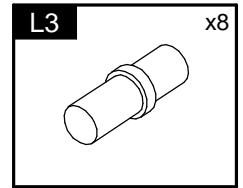
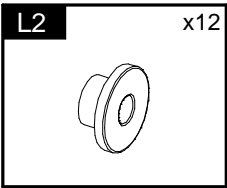
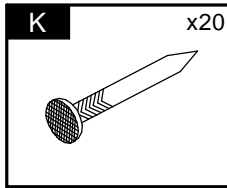
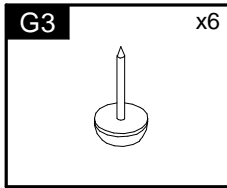
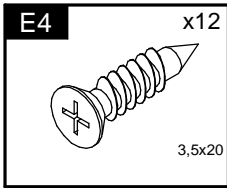
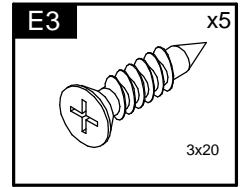
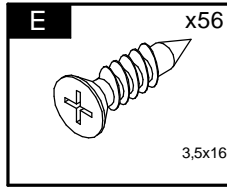
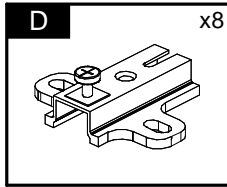
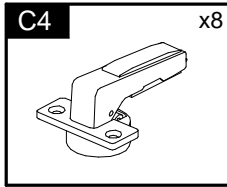
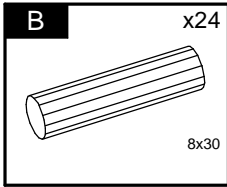
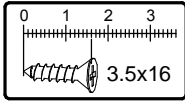

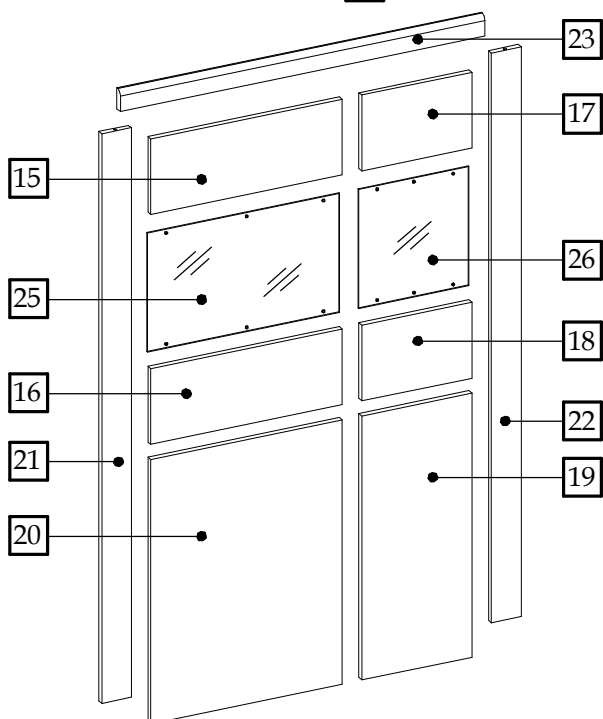
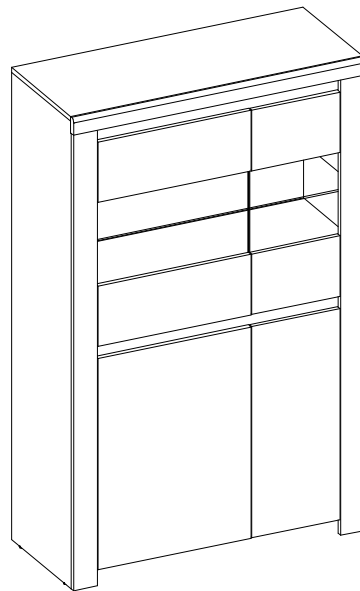
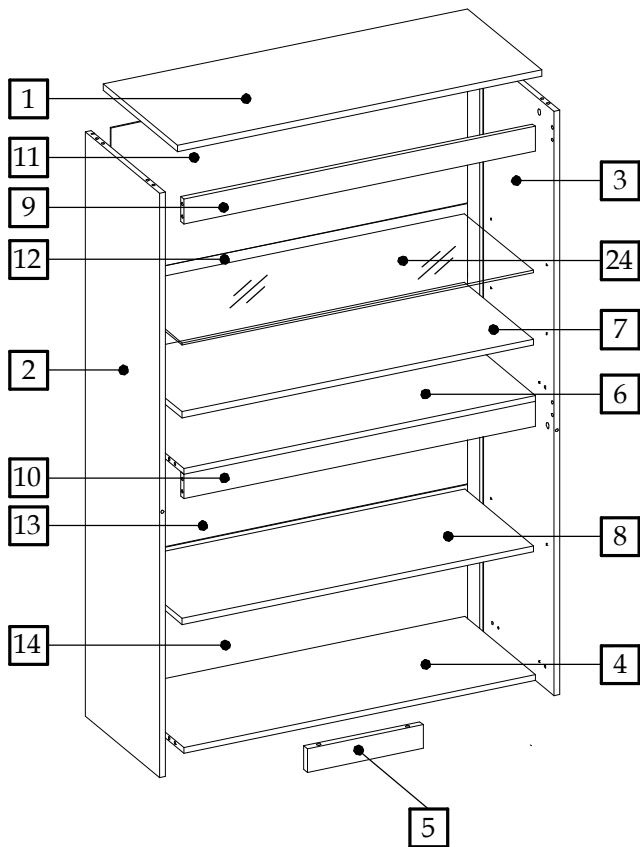

Element symbol	Measurements				Code	Paket
	1	2	3	4		
1	980	399	16	1	1029	1/3
2	1544	399	16	1	1003	1/3
3	1544	399	16	1	1004	1/3
4	946	379	16	1	1005	1/3
5	250	50	16	1	1008	1/3
6	946	379	16	1	1030	1/3
7	946	378	16	1	N/A	1/3
8	946	378	16	1	N/A	1/3
9	946	65	16	1	1025	1/3
10	646	65	16	1	1039	1/3
11	960	377	3	1	1031_v	1/3
12	960	377	3	1	N/A	1/3
13	960	371	3	1	N/A	1/3
14	960	371	3	1	N/A	1/3
15	516	202	16	1	1001/3001	1/3
16	516	202	16	1	1002/3002	1/3
17	298	202	16	1	1013/3003	2/3
18	298	202	16	1	1014/3004	2/3
19	699	298	16	1	1015/3005	2/3
20	699	516	16	1	1016/3006	2/3
21	1507	82	16	1	1017/3007	1/3
22	1507	82	16	1	1017/3008	1/3
23	982	56	19	1	1018/3009	1/3
24	945	370	6	1	Glass	3/3
25	335	513	4	1	Glass	3/3
26	335	295	4	1	Glass	3/3

2

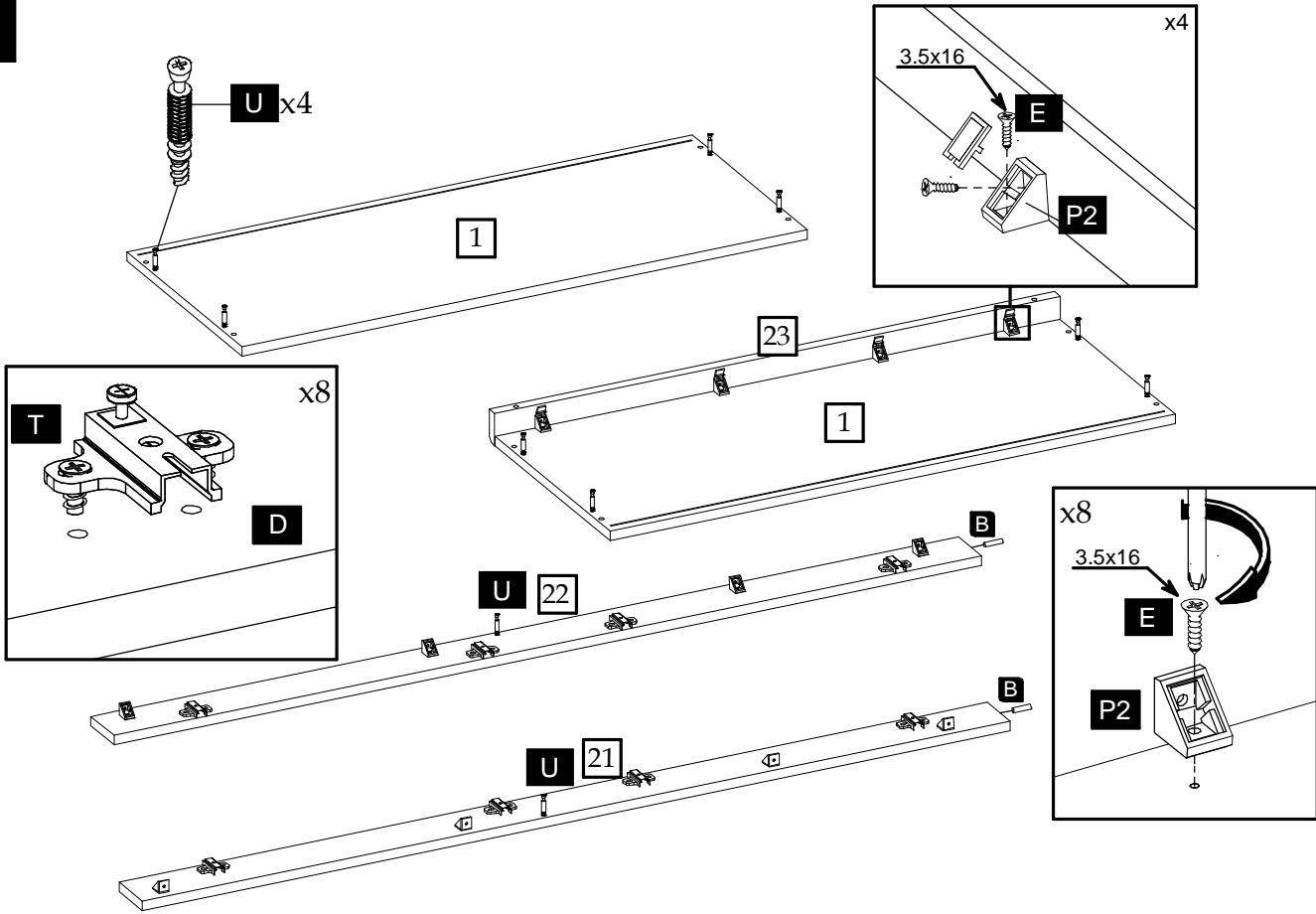

3

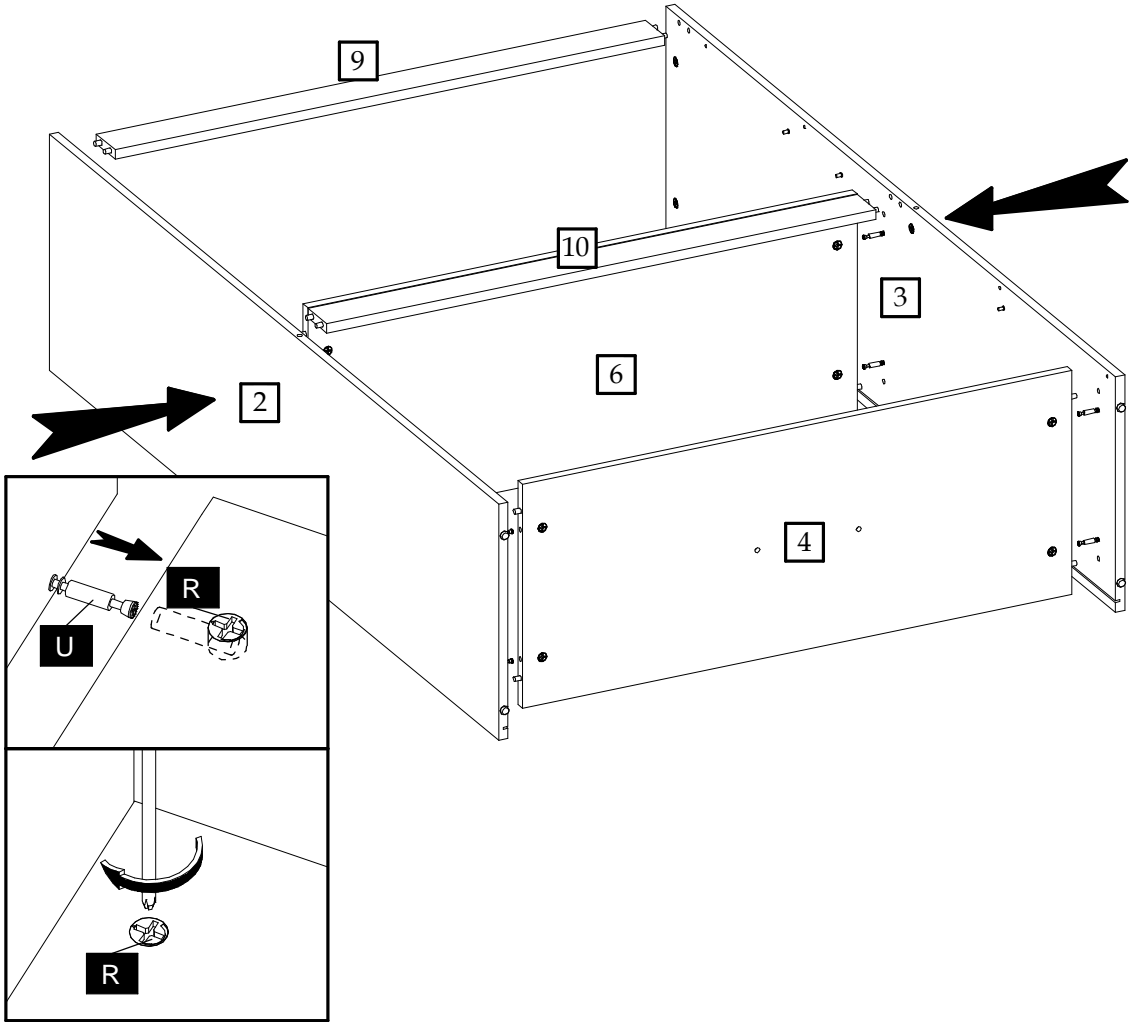

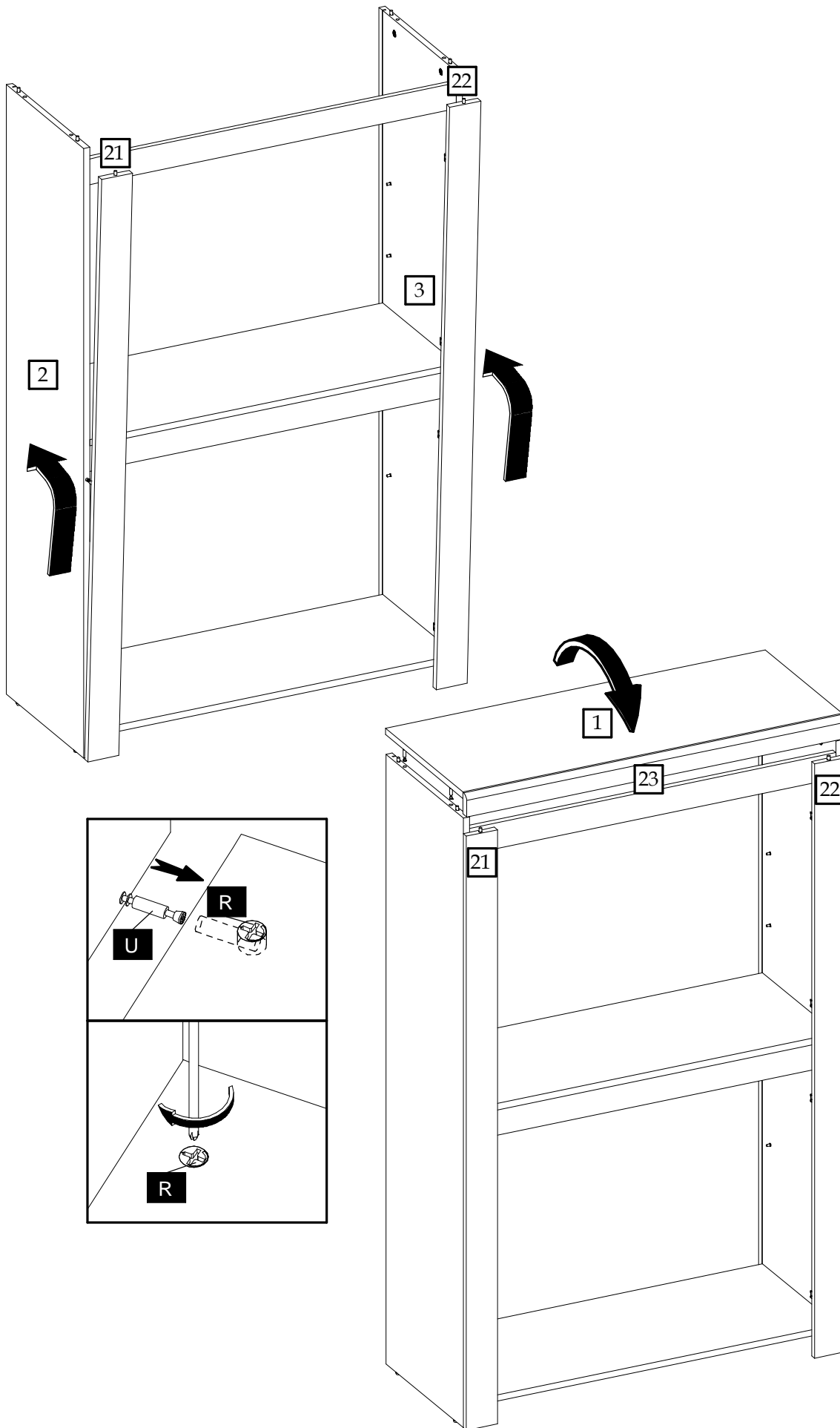

5

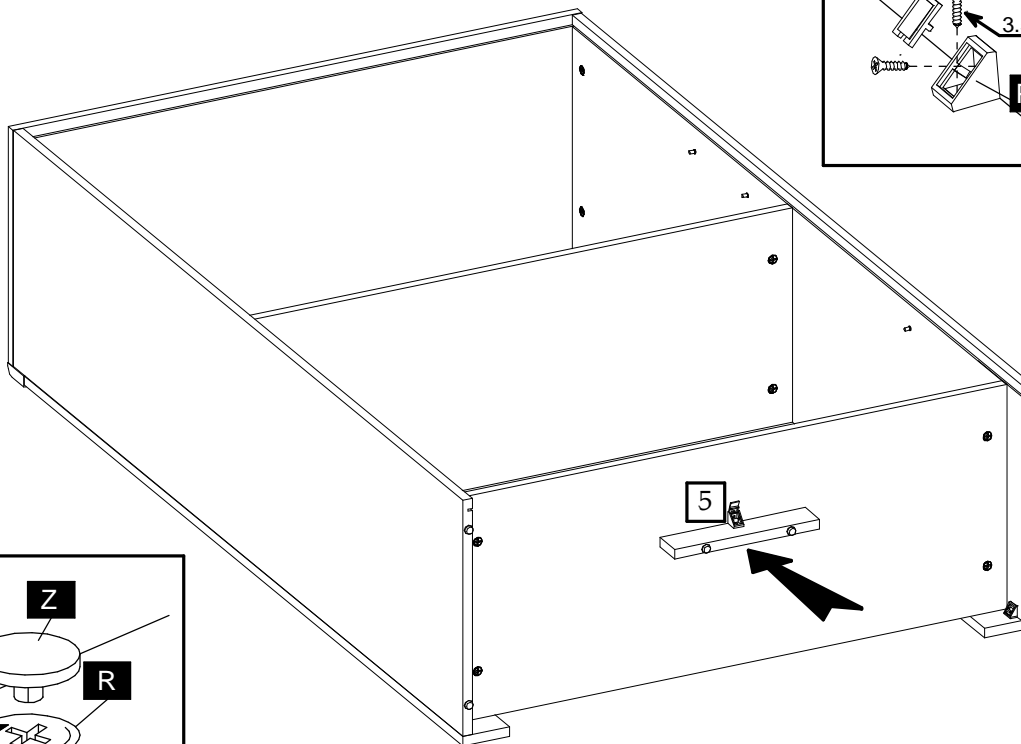

6

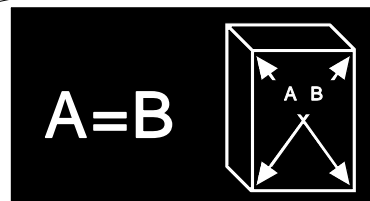
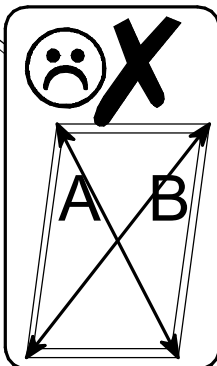
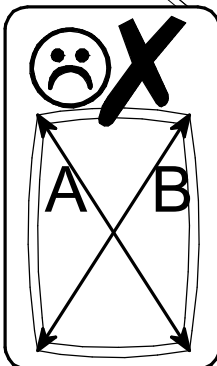
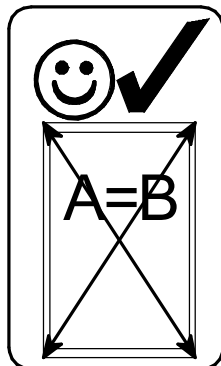
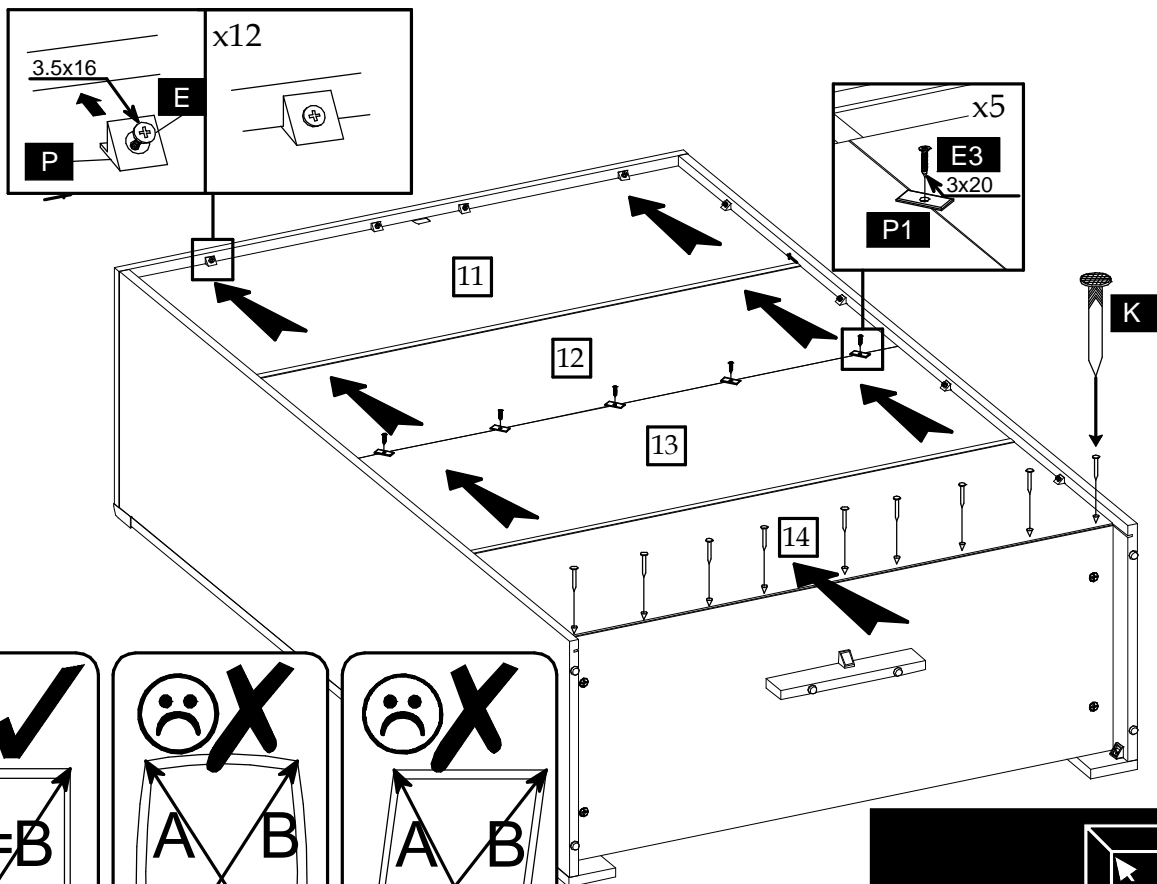

7

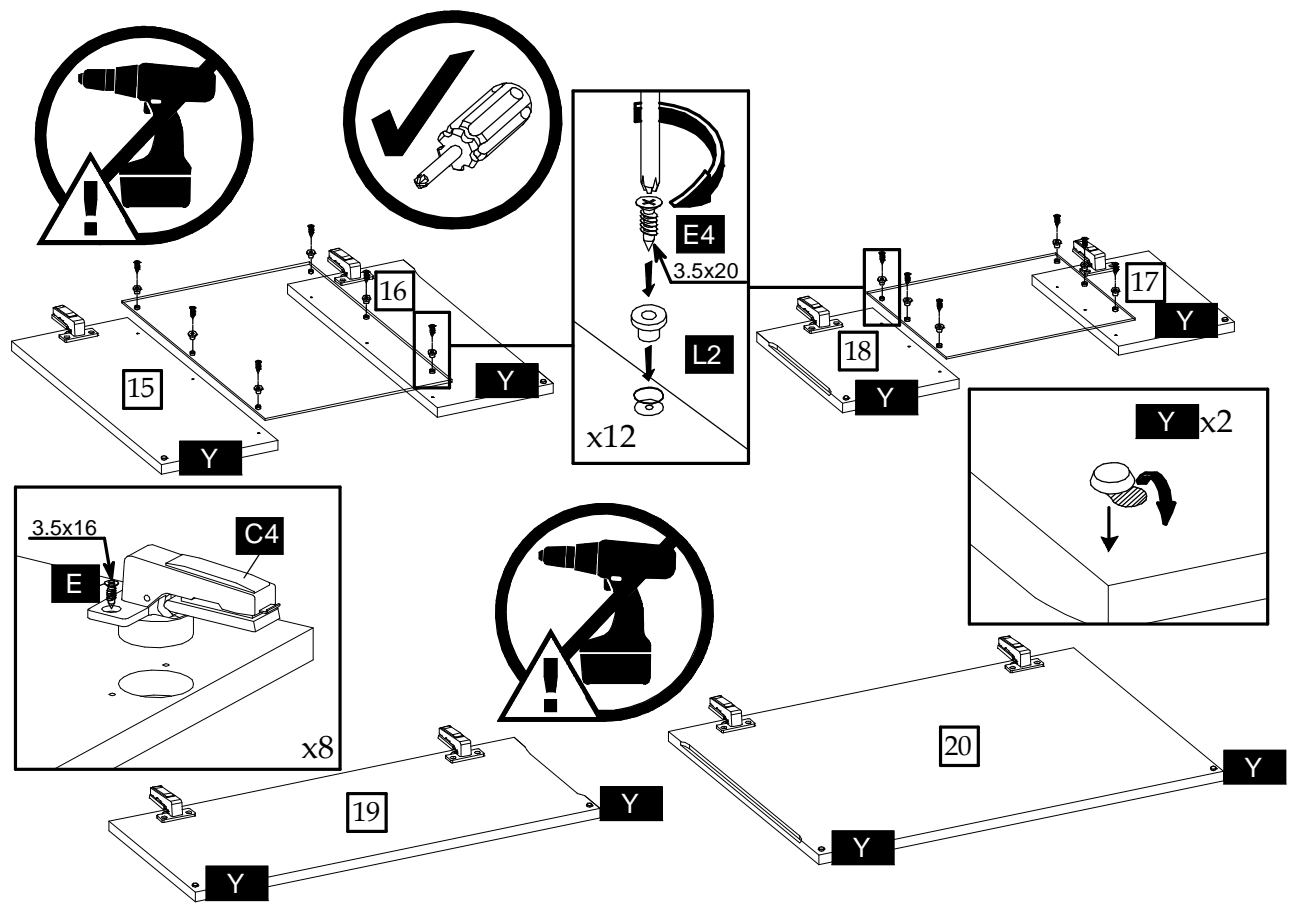

8

