

MARTIN

Typ G

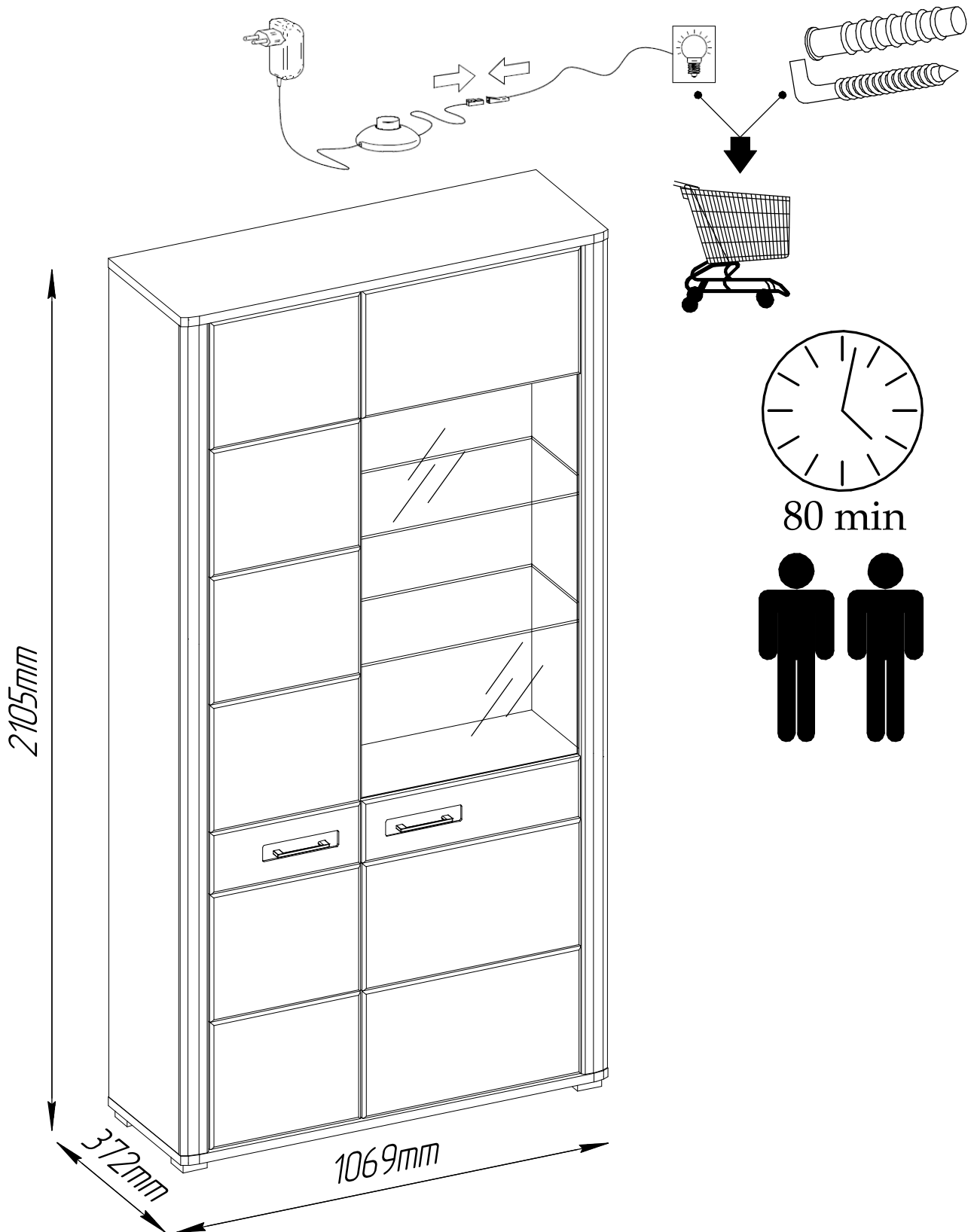

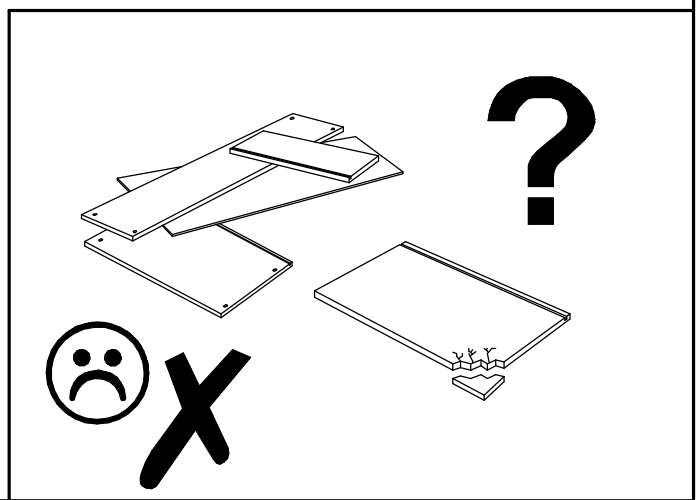

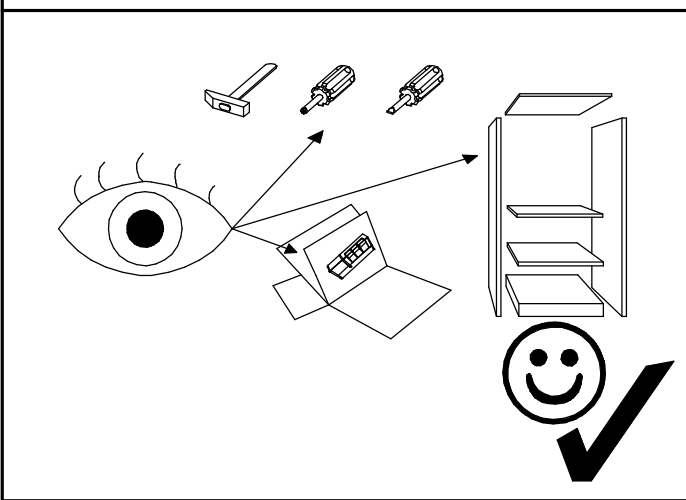
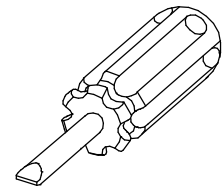
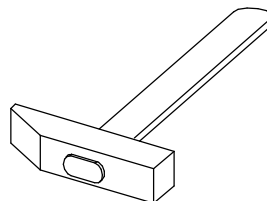
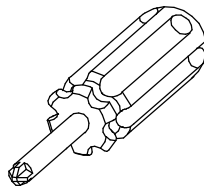
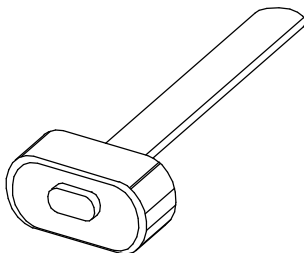
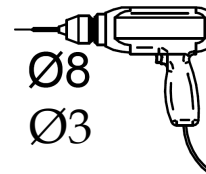
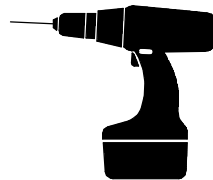
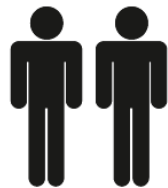
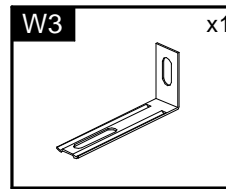
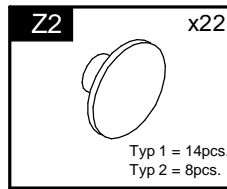
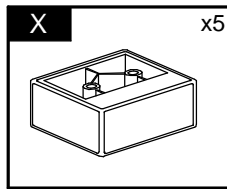
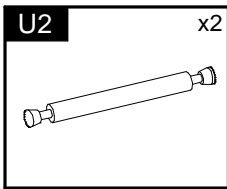
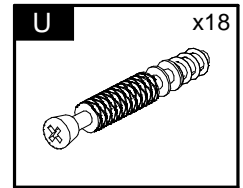
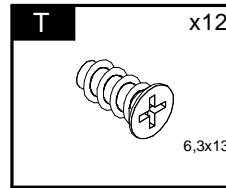
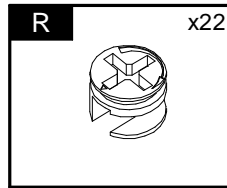
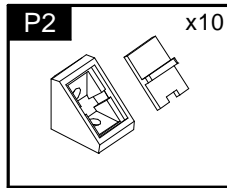
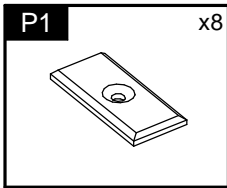
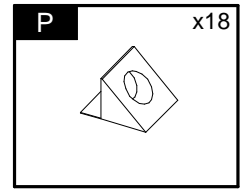
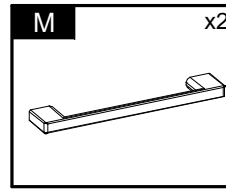
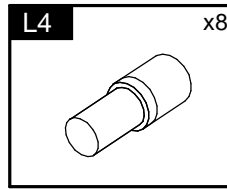
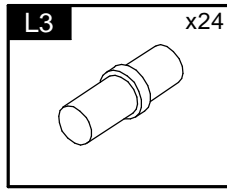
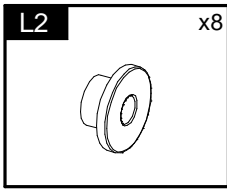
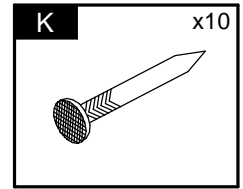
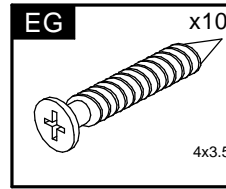
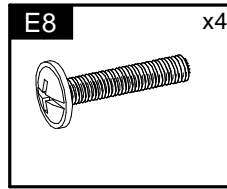
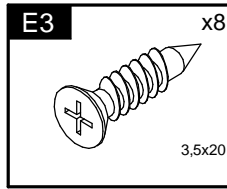
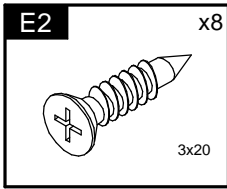
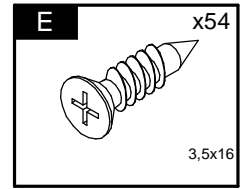
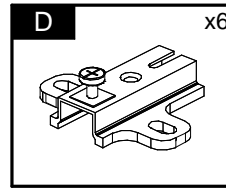
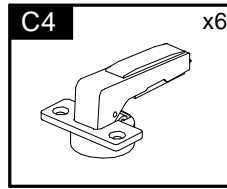
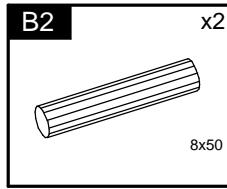
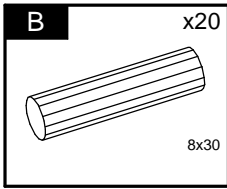

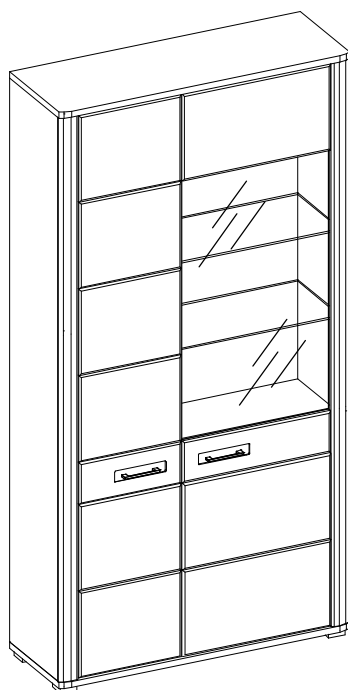

Element symbol	Measurements				Code	Paket
1	1069	372	22	1	1001	1/4
2	1069	372	22	1	1002	1/4
3	2036	350	16	1	1003	2/4
4	2036	350	16	1	1004	2/4
5	2036	337	16	1	1005	2/4
6	424.5	336.5	16	1	1007	1/4
7	594.5	336.5	16	1	1012	3/4
8	594.5	330	16	2	N/A	1/4
9	424.5	330	16	4	N/A	1/4
10	2048	437	2.5	1	N/A	3/4
11	2048	607	2.5	1	N/A	3/4
12	2036	68	19	1	1017	3/4
13	2036	68	19	1	1029	3/4
14	2031	377	19	1	3017	3/4
15	779	547	19	1	3016	3/4
16	547	313	19	1	3015	3/4
17	593	315	6	2	N/A	4/4
18	999	538	4	1	N/A	4/4

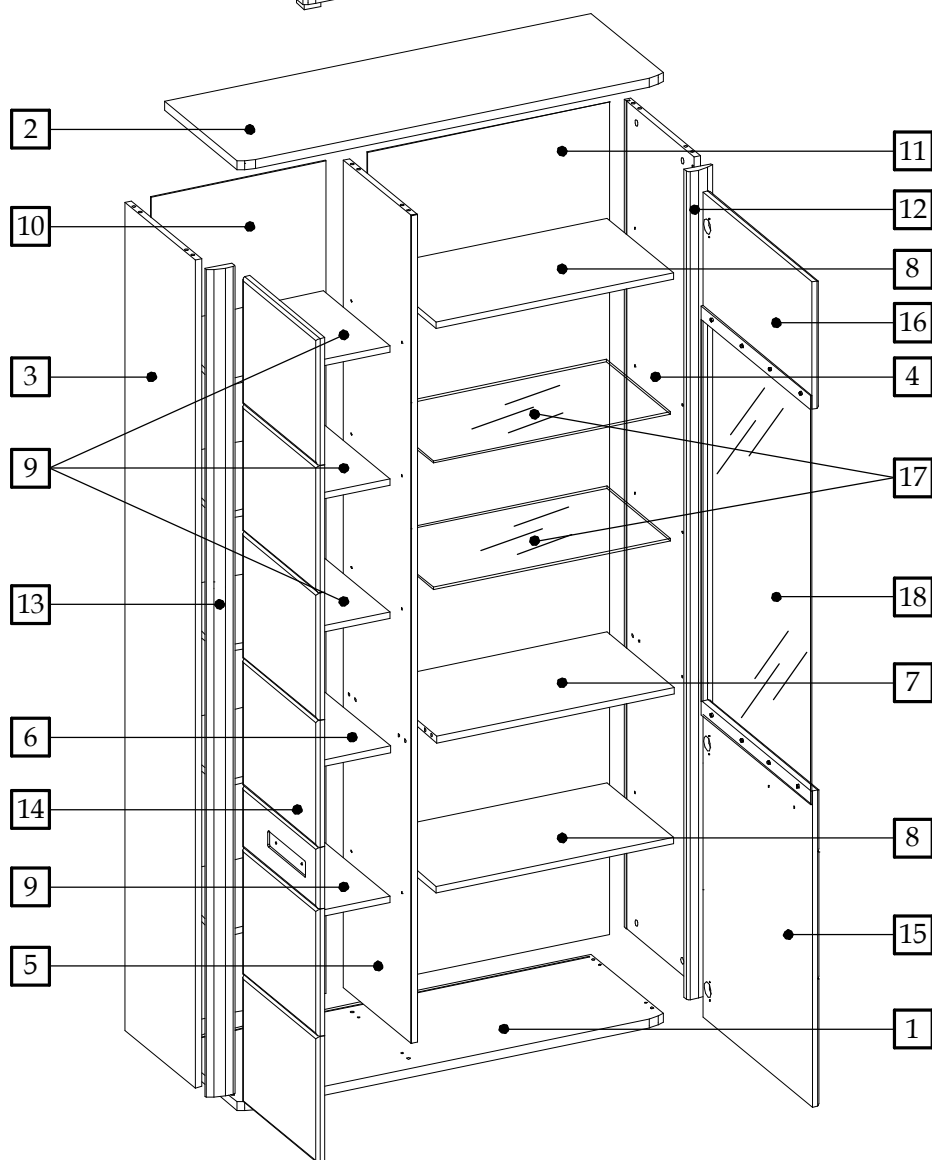



1

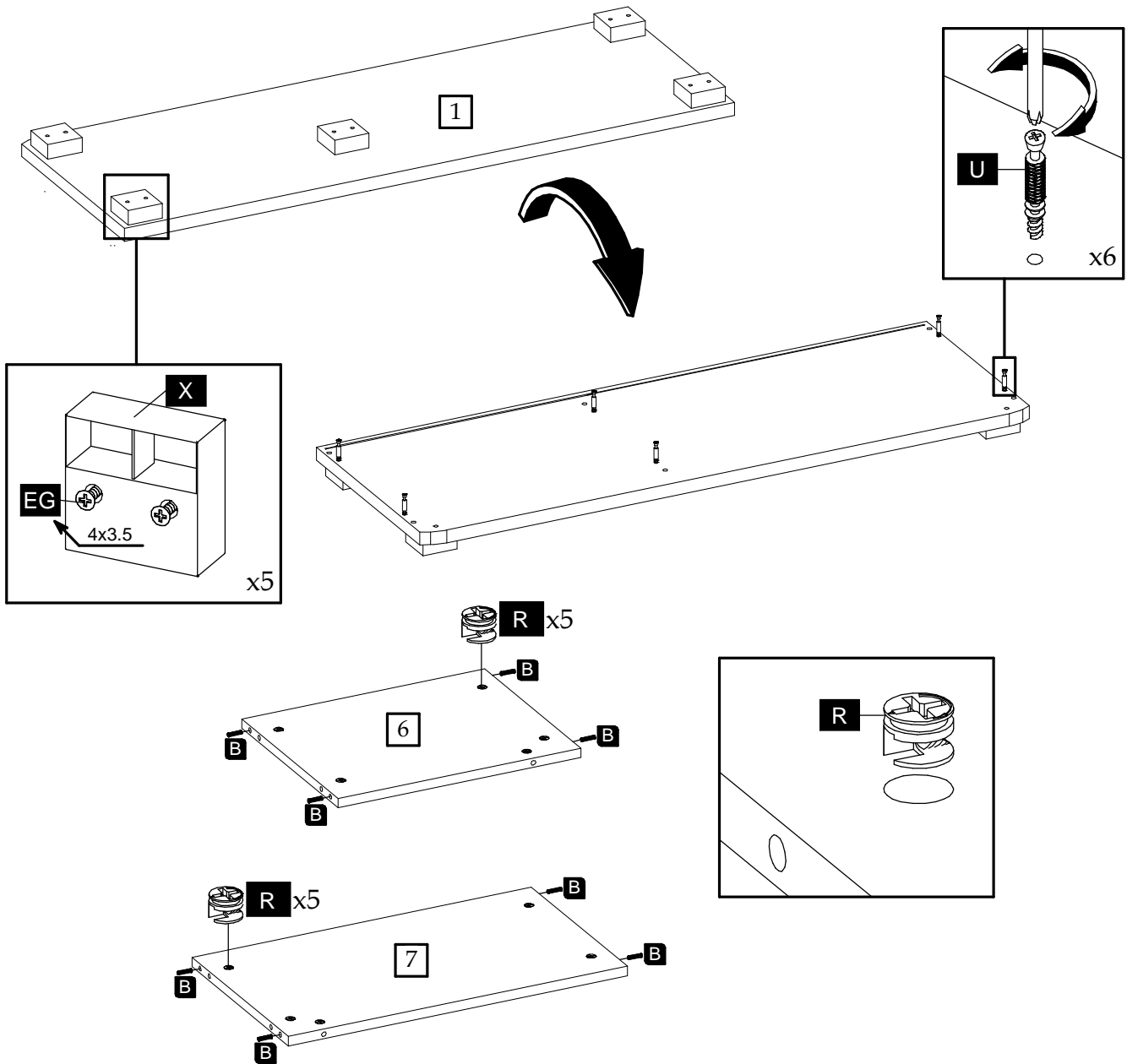

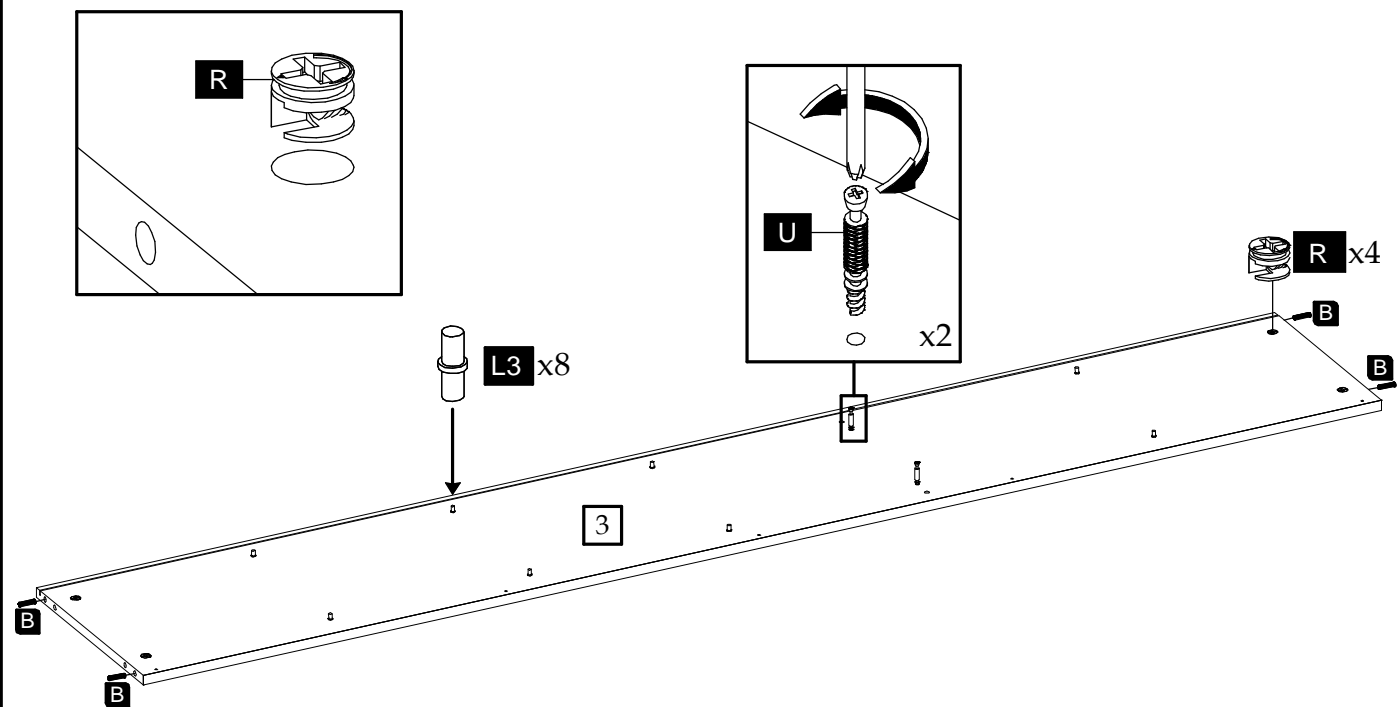
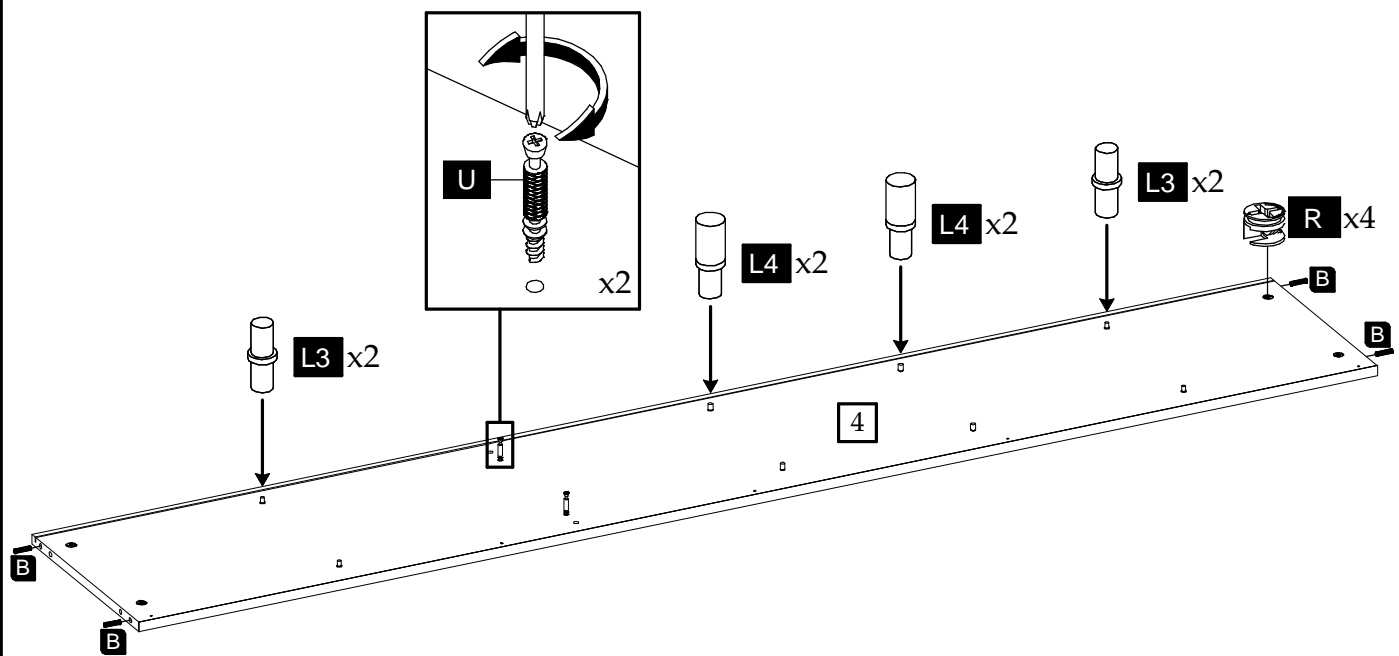
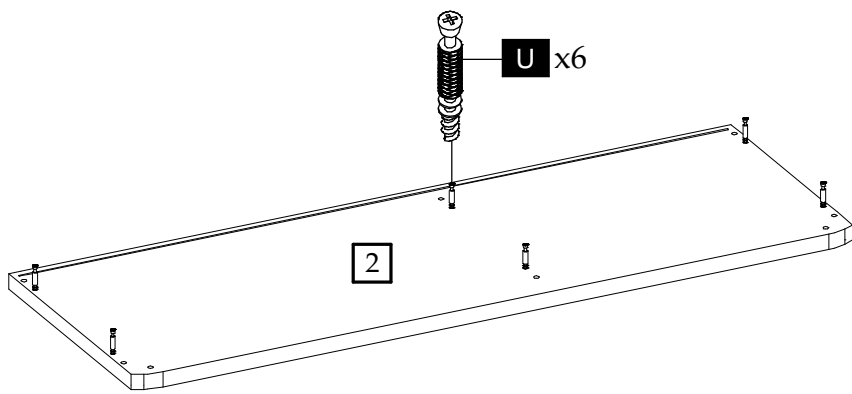

3

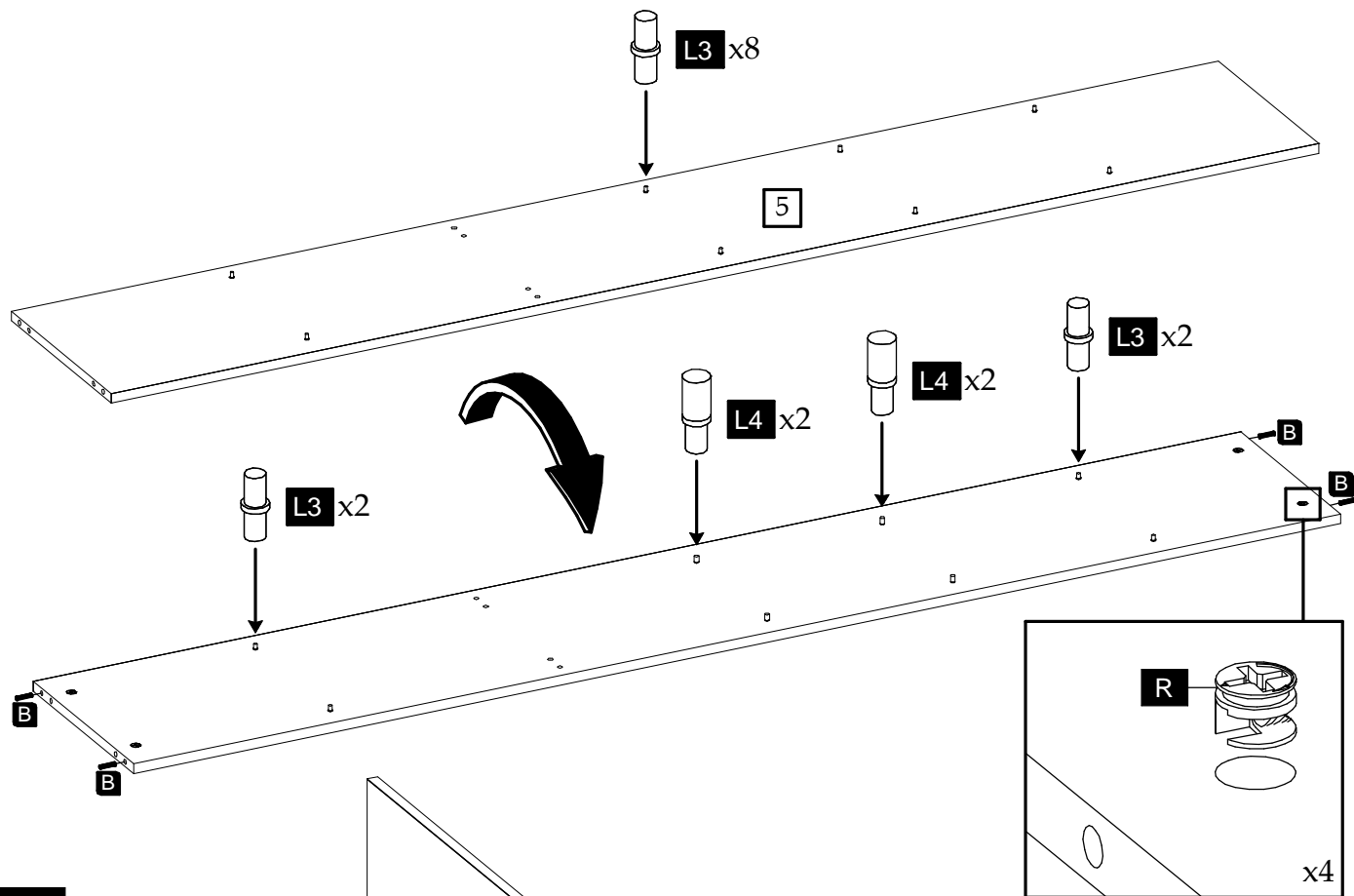

4

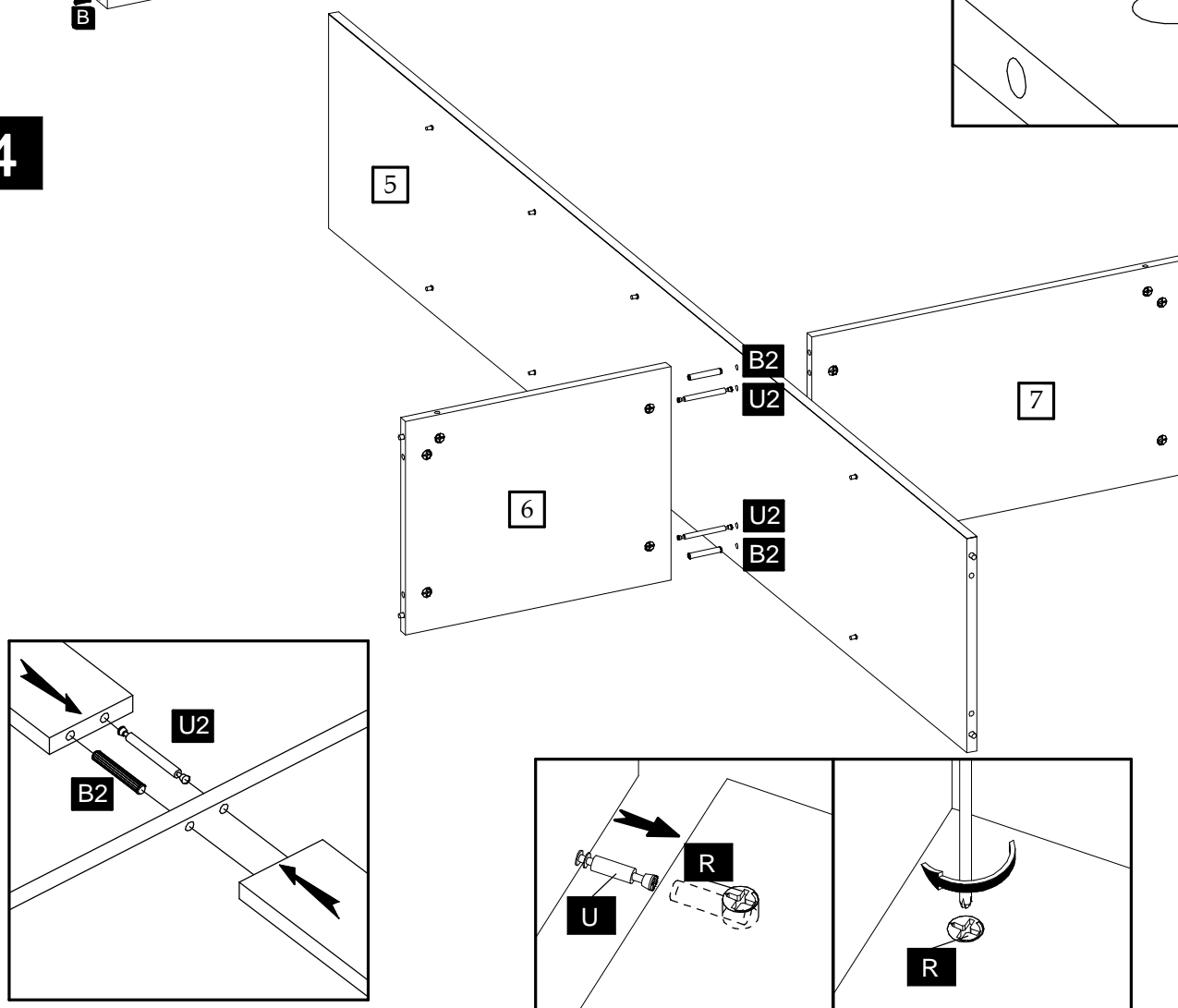

5

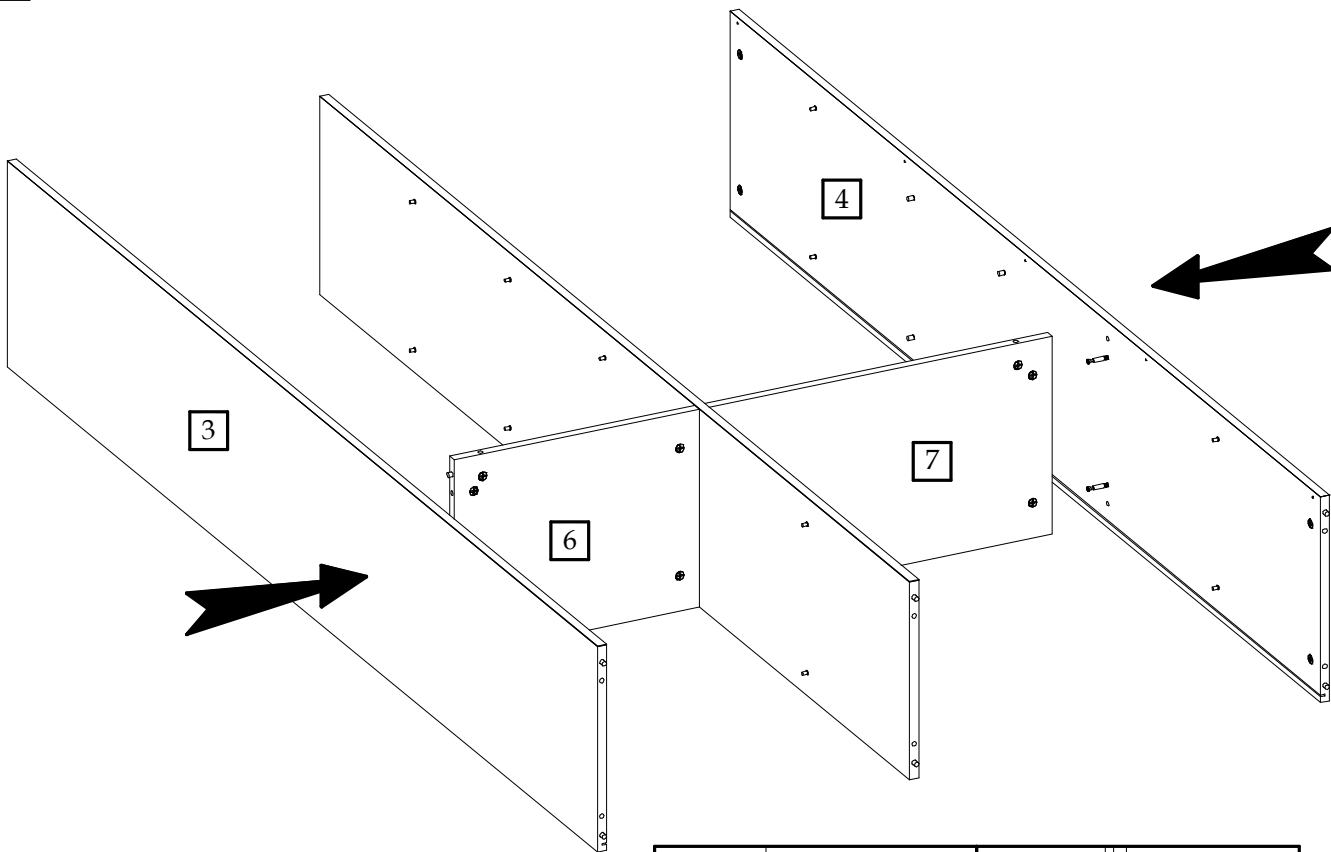

6

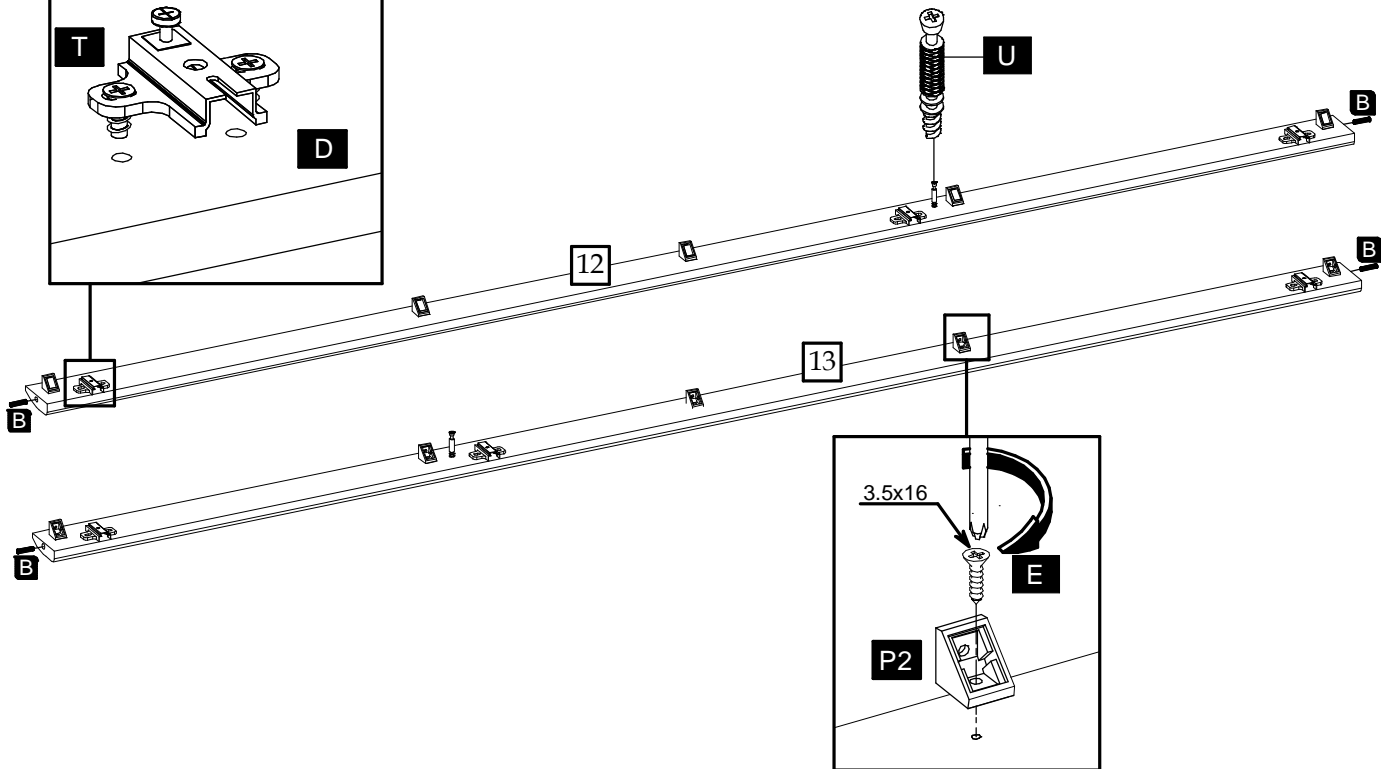
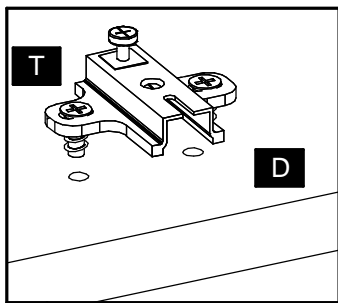
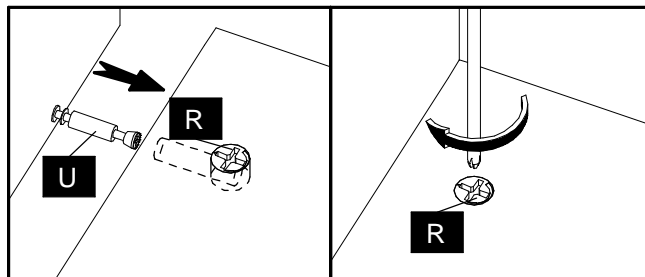

7

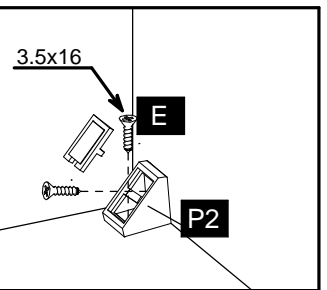
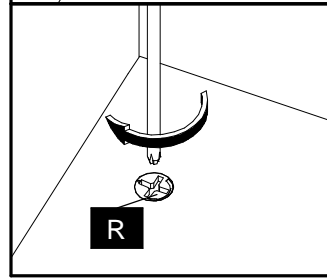
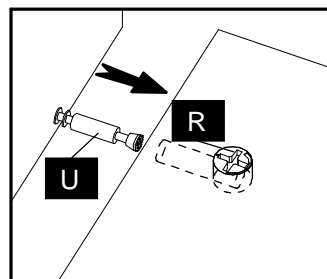
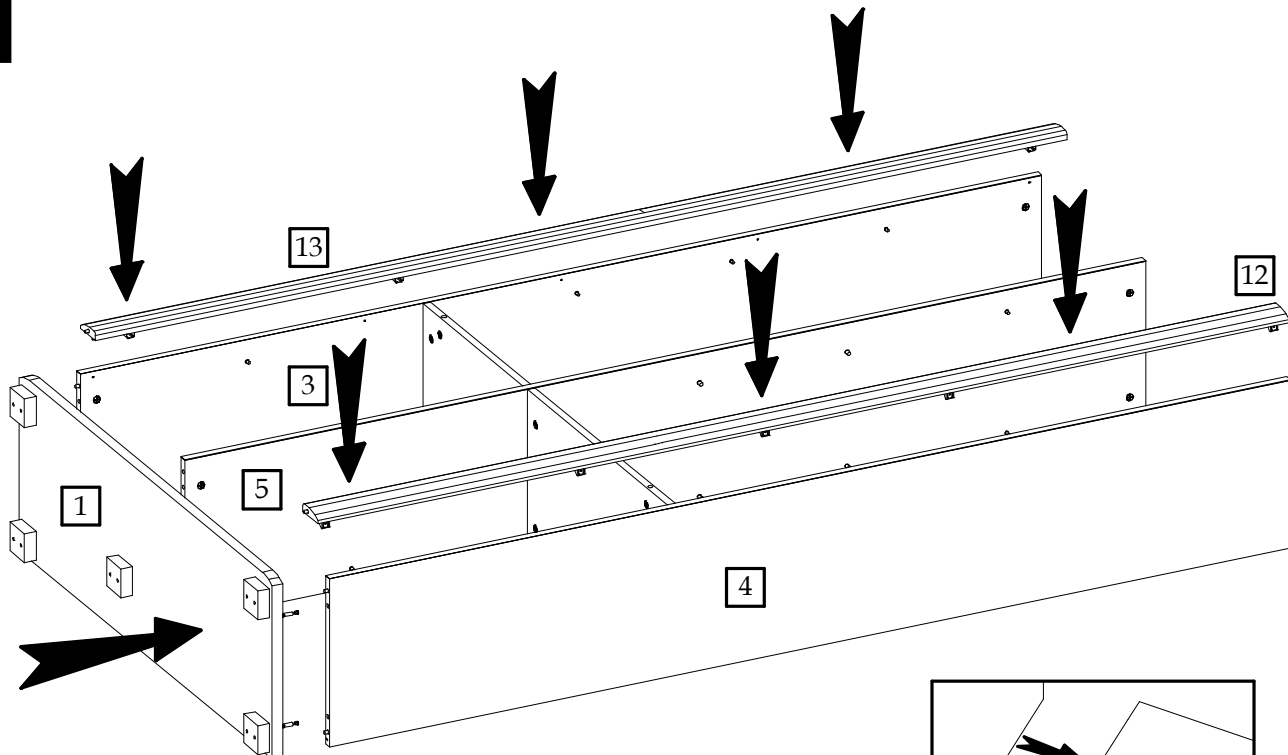

8

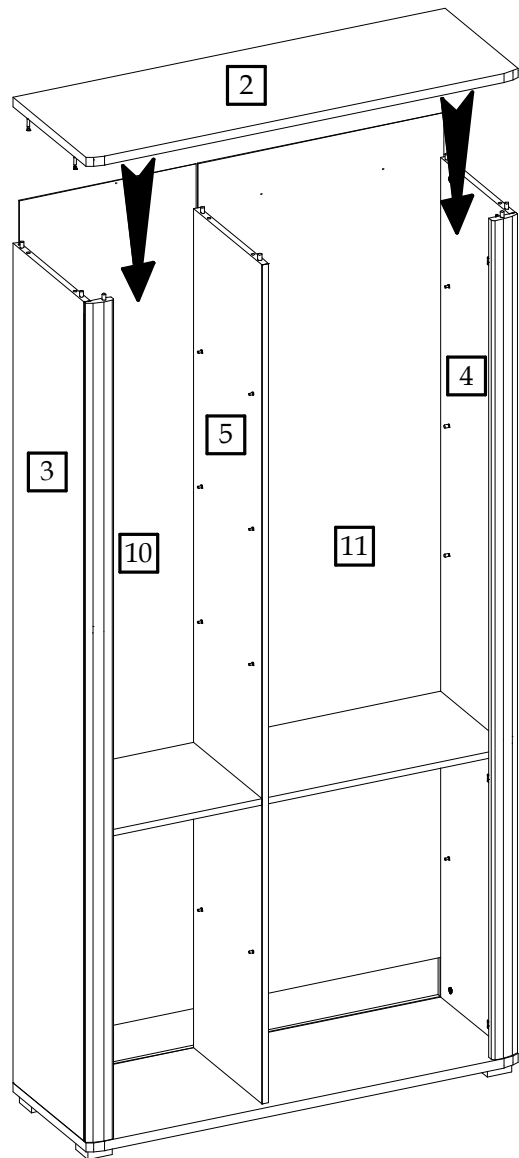

9

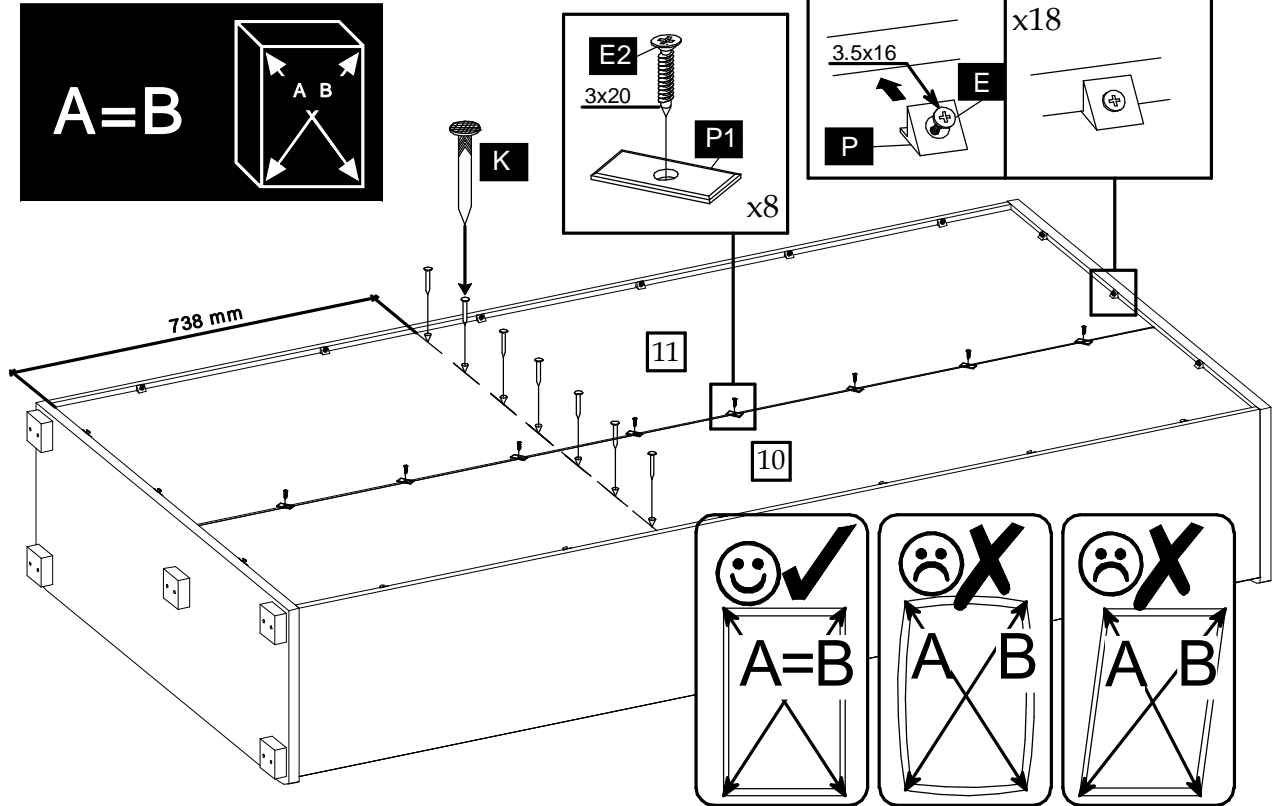
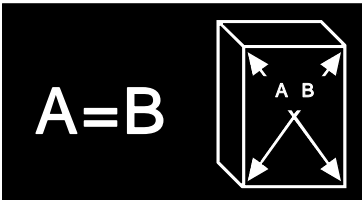

10

