

MARTIN

Typ N

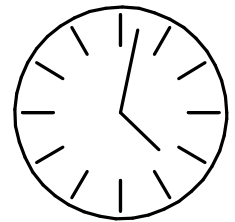

90 min

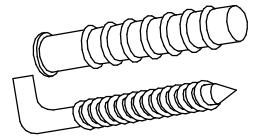
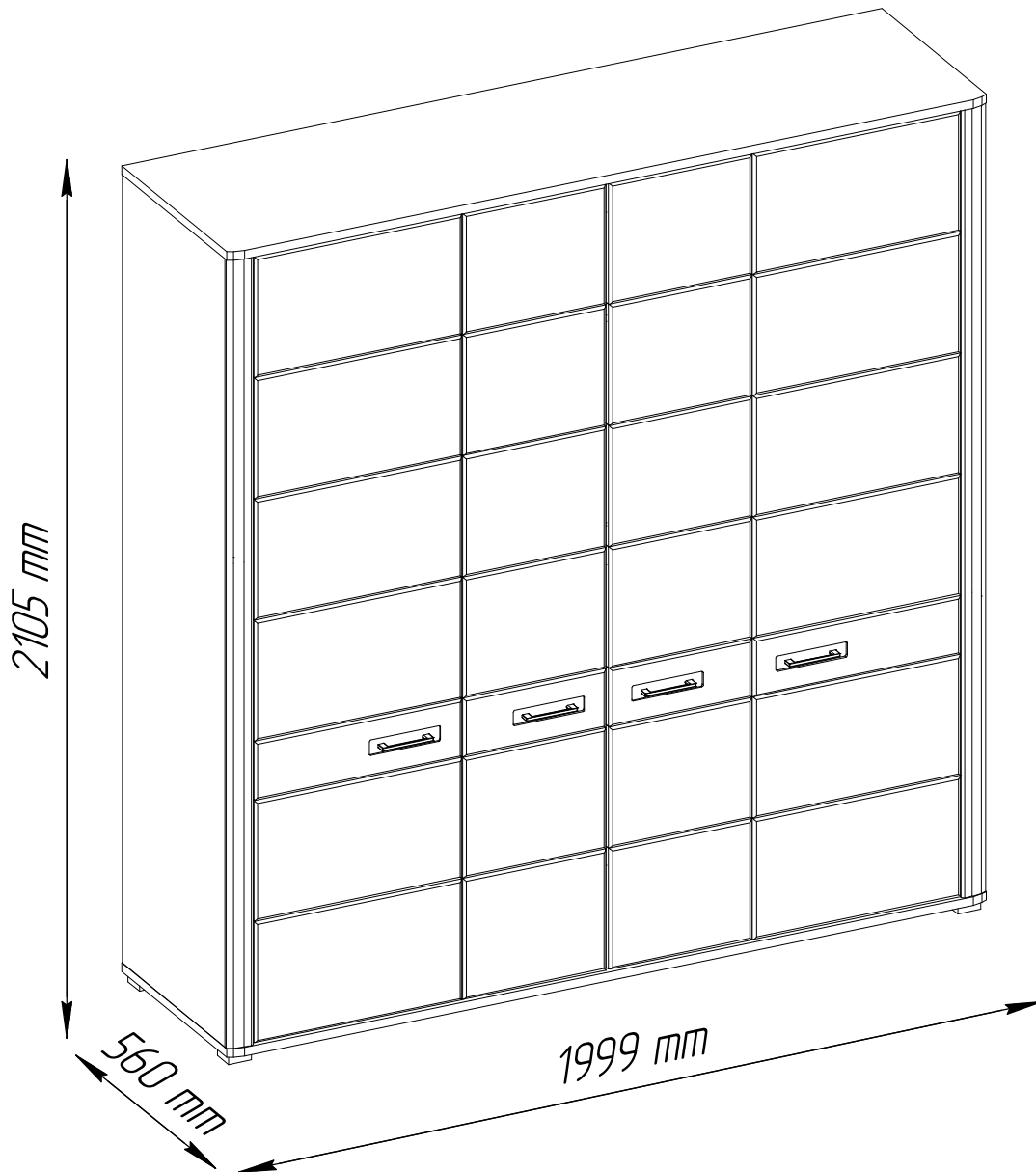
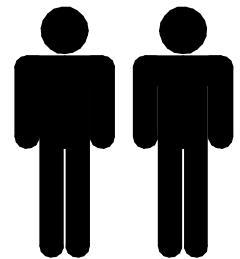

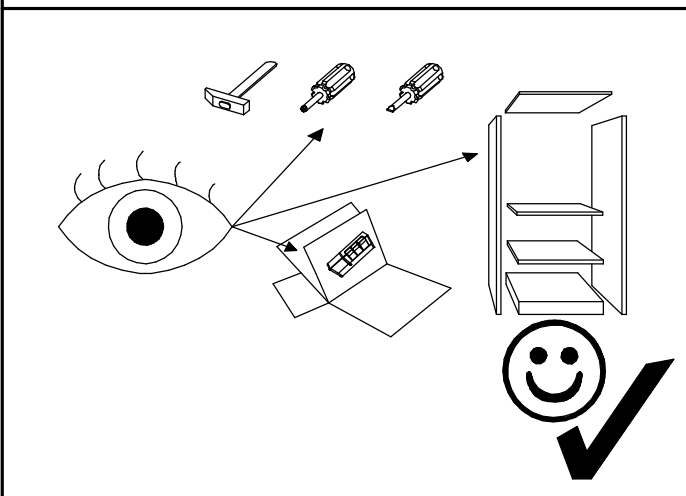

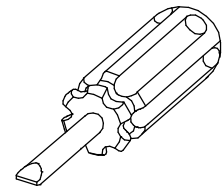
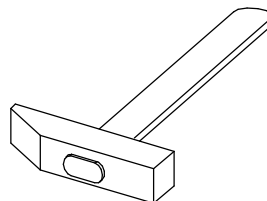
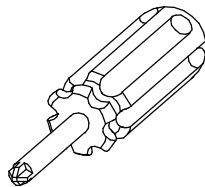
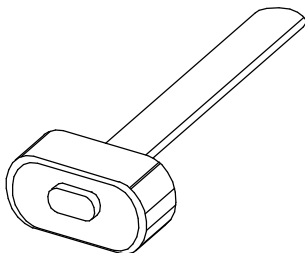
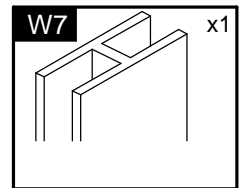
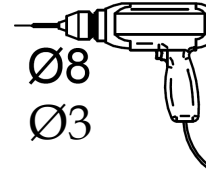
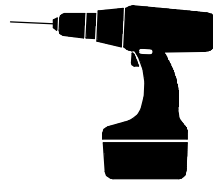
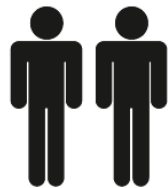
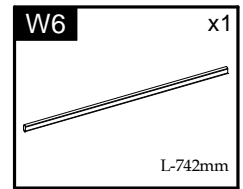
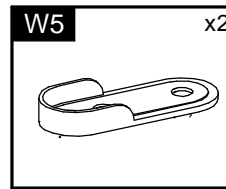
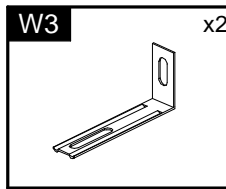
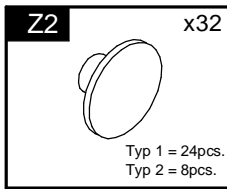
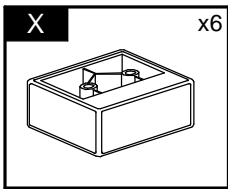
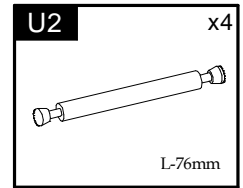
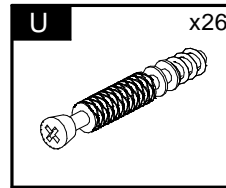
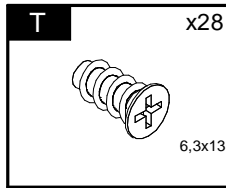
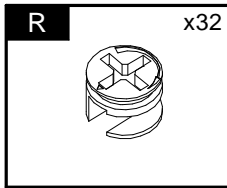
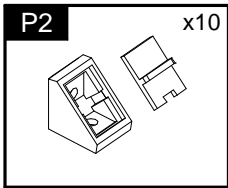
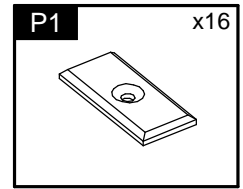
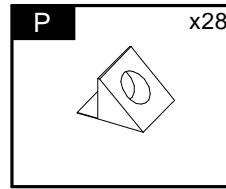
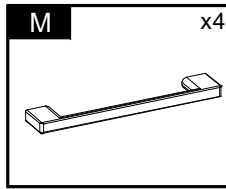
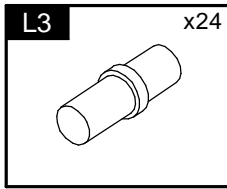
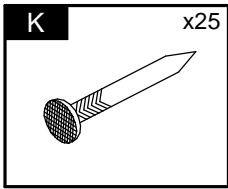
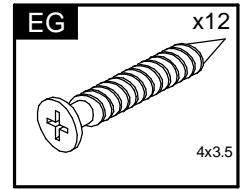
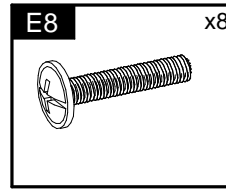
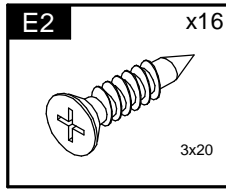
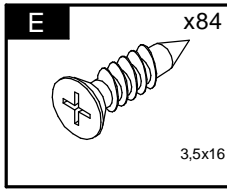
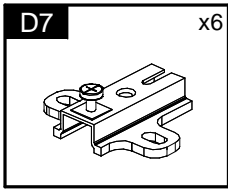
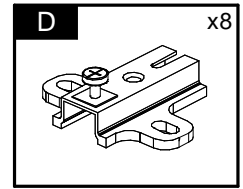
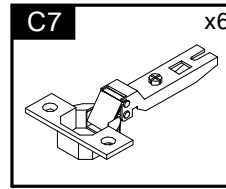
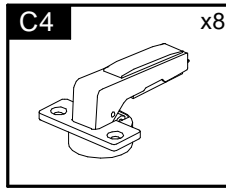
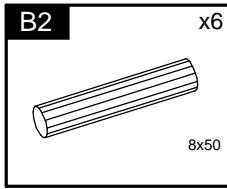
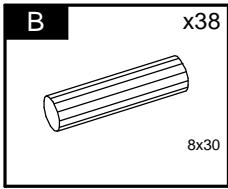

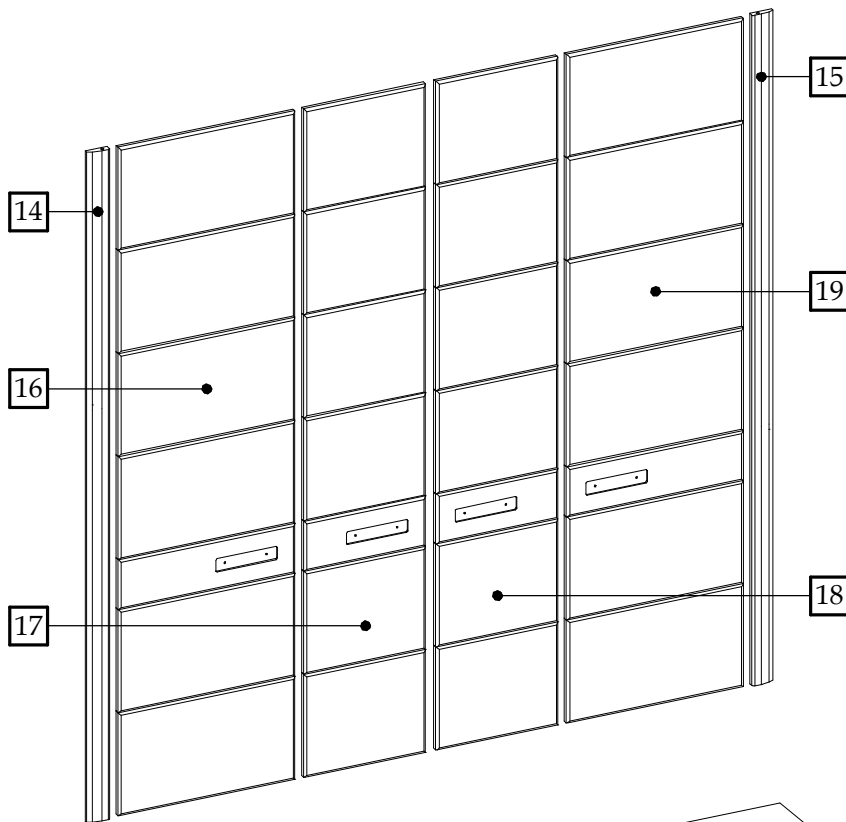

Element symbol	Measurements				Code	Paket
	1	2	3	4		
1	1999	560	22	1	1001	1/2
2	1999	560	22	1	1002	
3	2036	538	16	1	1003	
4	2036	538	16	1	1004	
5	2036	525	16	1	1005	
6	2036	525	16	1	1006	
7	593.5	524.5	16	1	1008	
8	593.5	515	16	6	N/A	
9	746	524.5	16	1	1012	
10	746	100	16	1	1013	
11	593.5	524.5	16	1	1014	
12	2050	608	2.5	2	N/A	
13	2050	380	2.5	2	N/A	
14	2036	68	19	1	1028	
15	2036	68	19	1	1029	
16	2031	547	19	1	3032	
17	2031	377	19	1	3031	
18	2031	377	19	1	3034	
19	2031	547	19	1	3033	

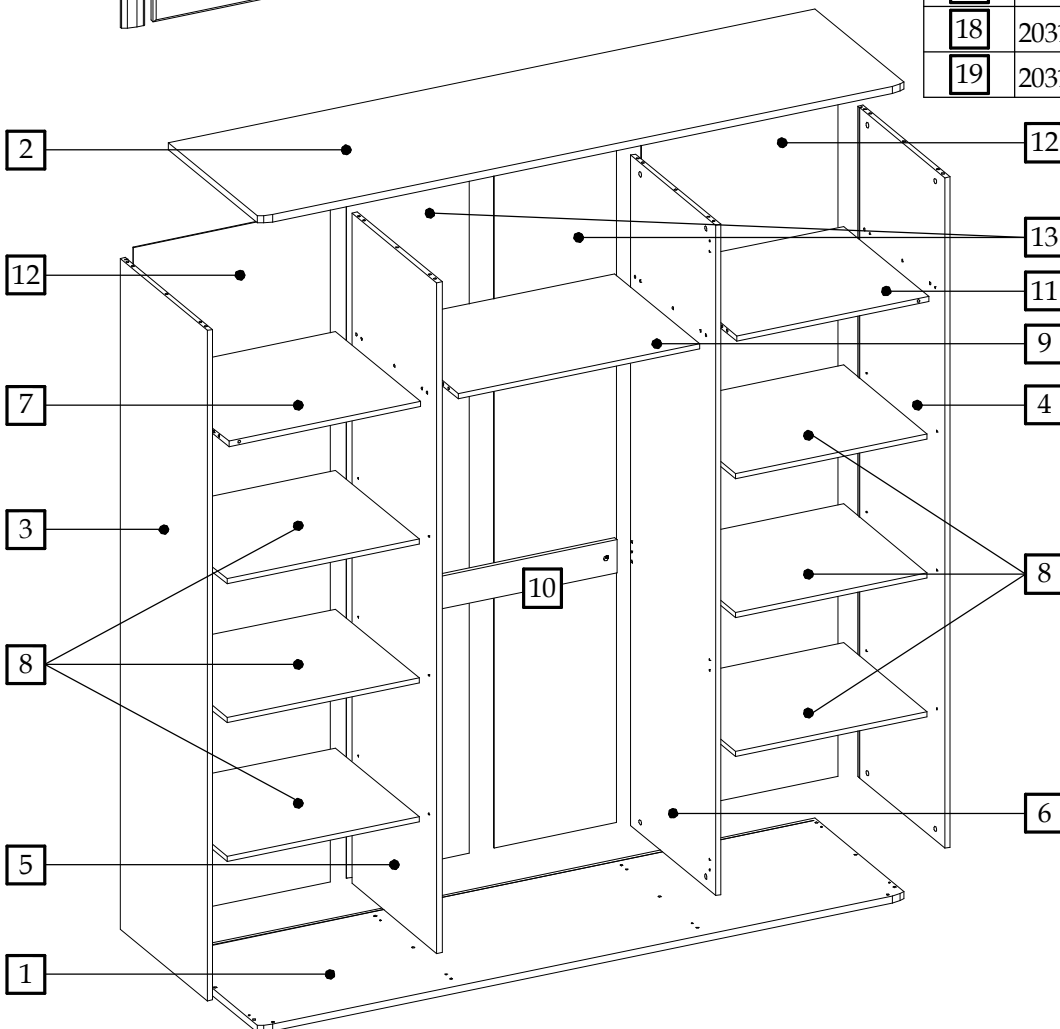



1

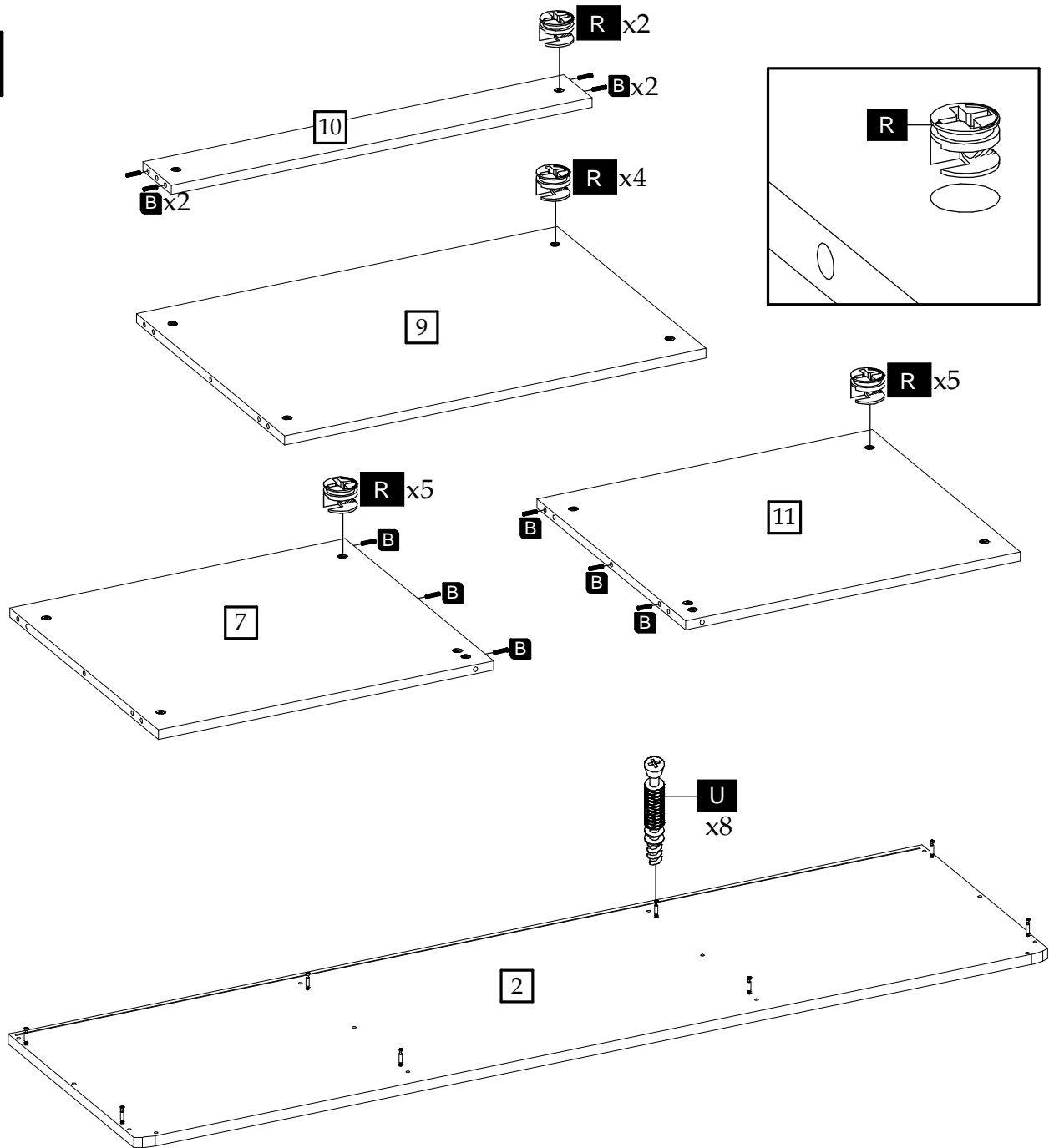

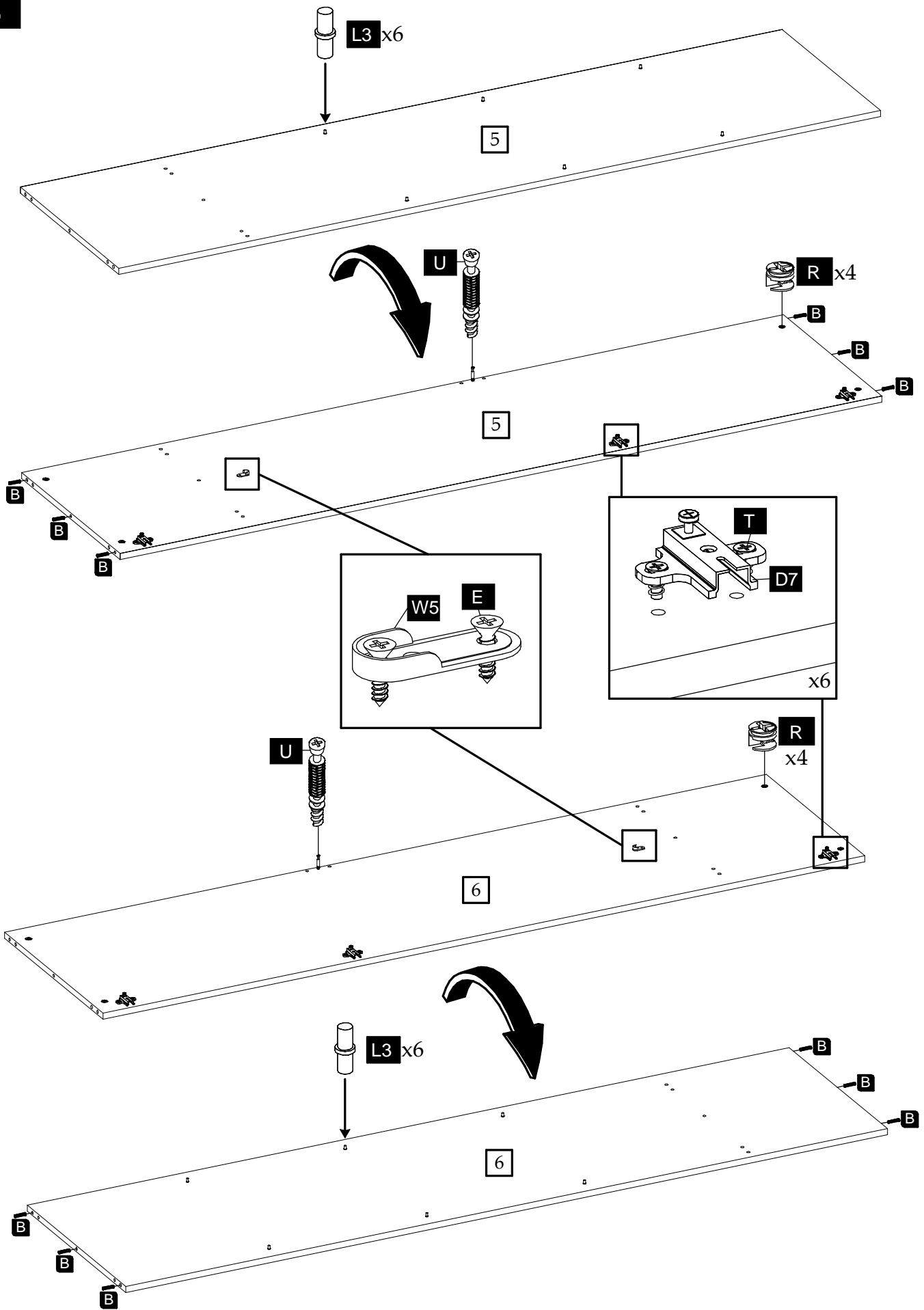

3

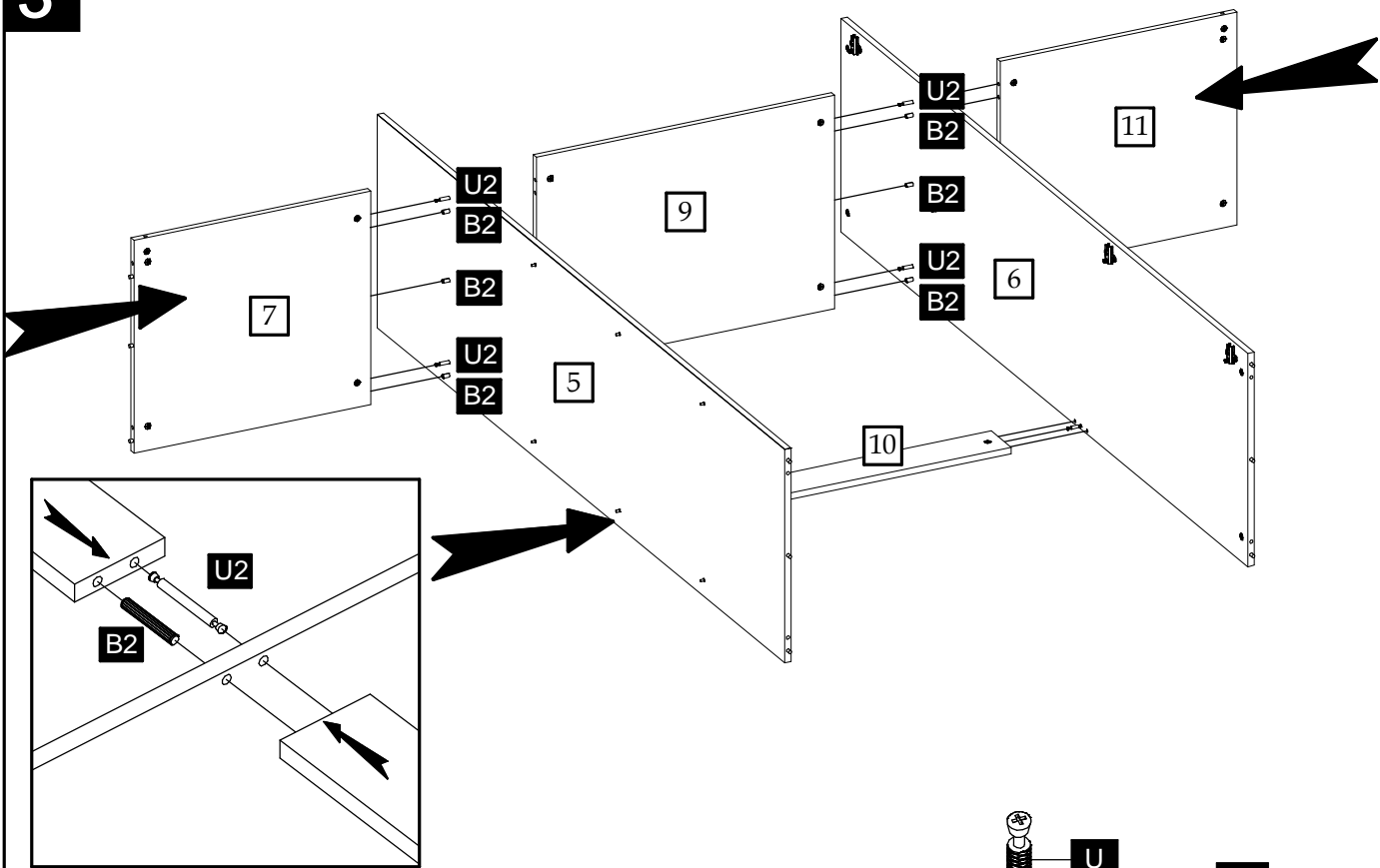

4

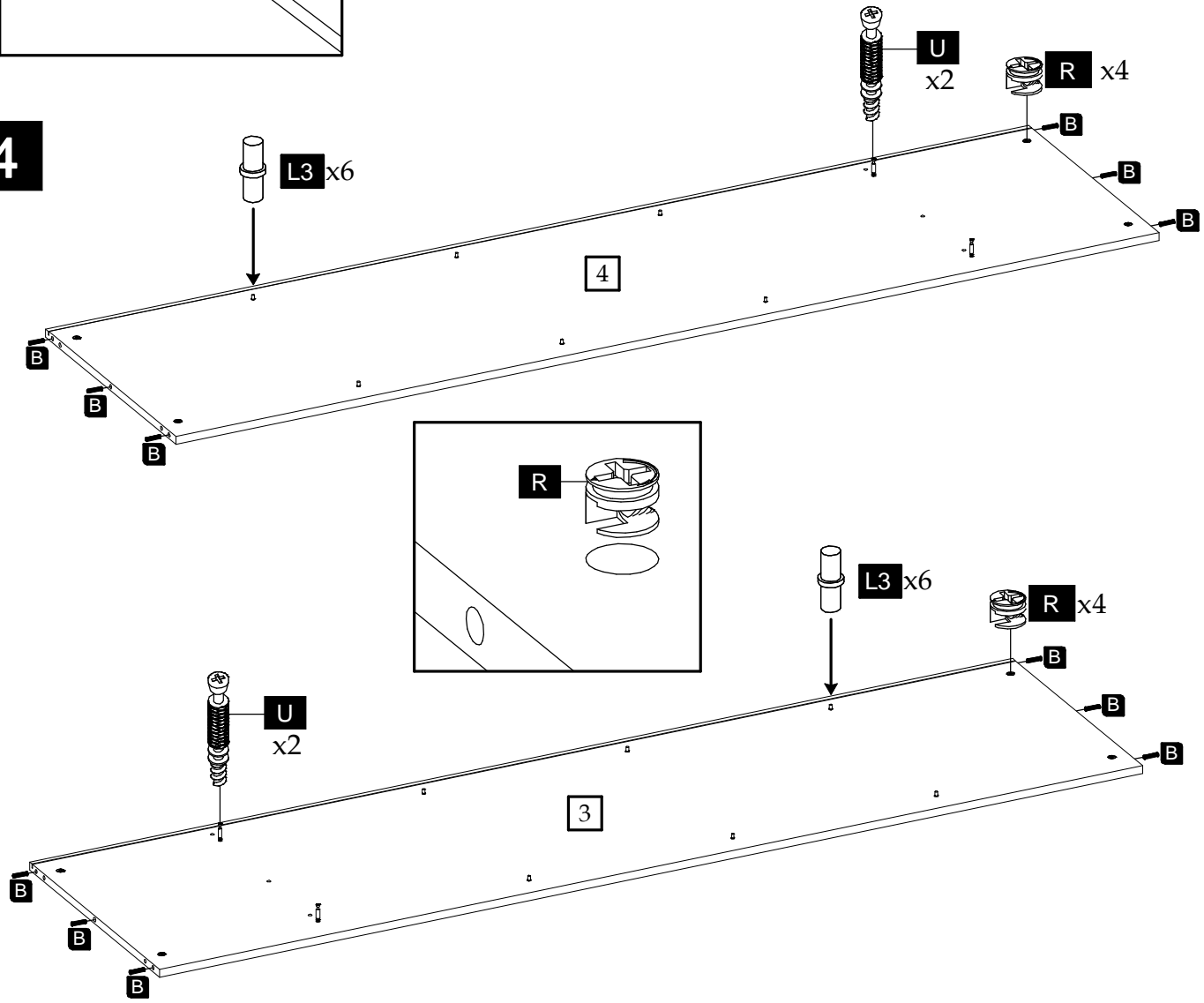

5

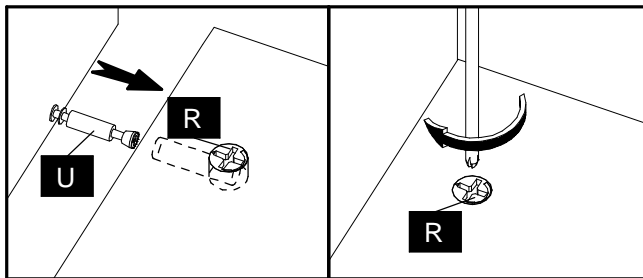
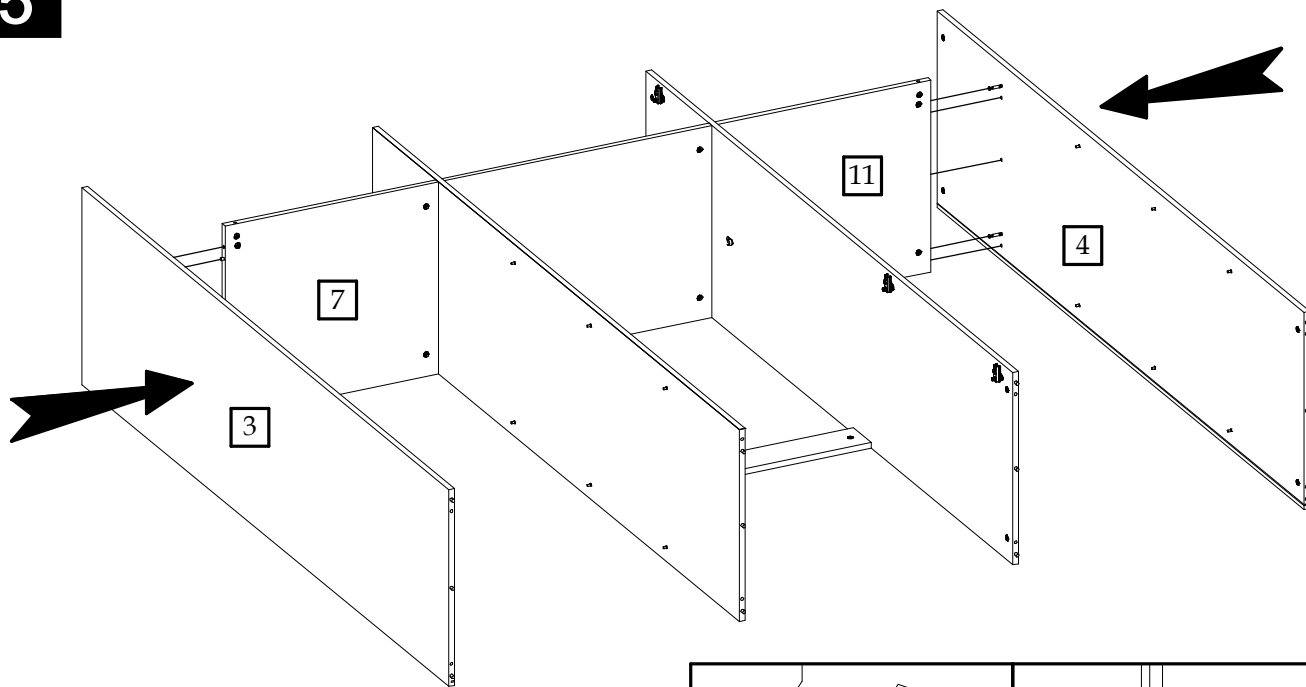

6

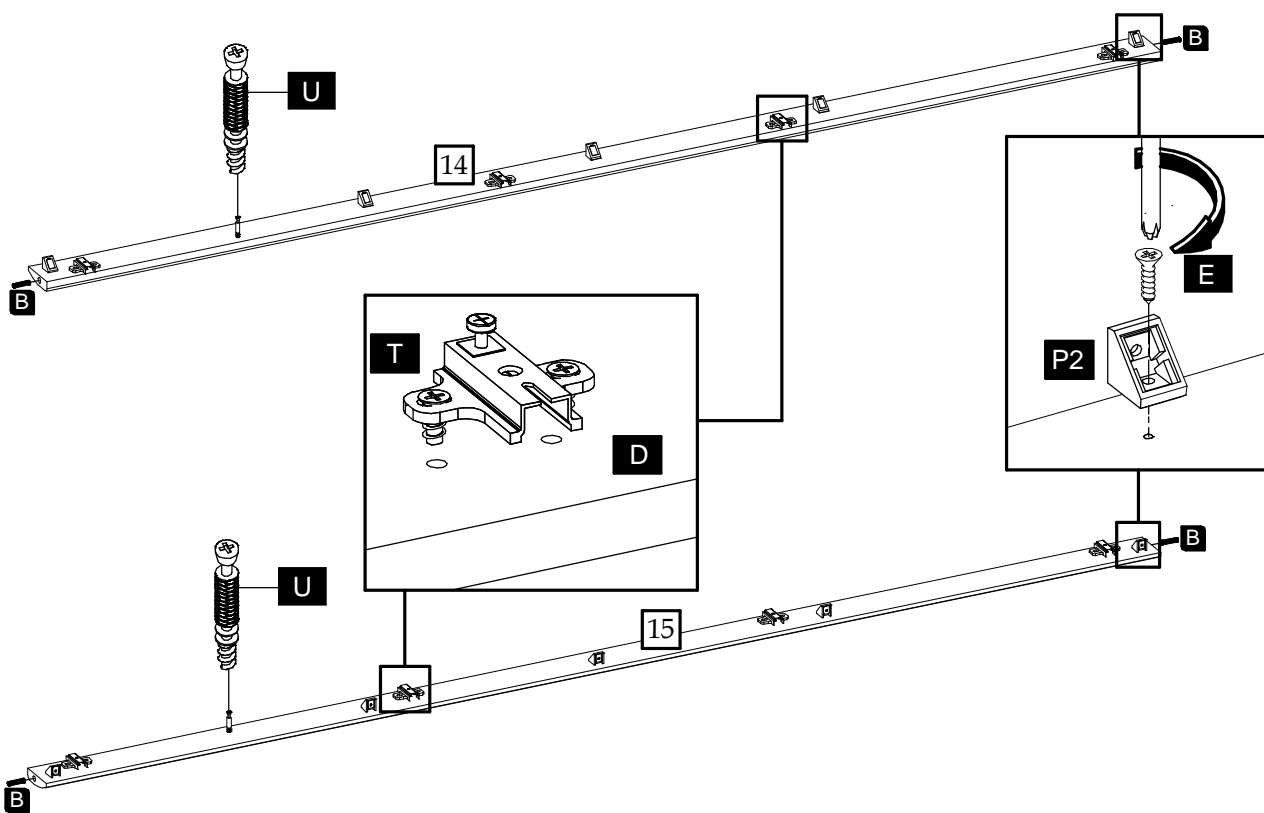

7

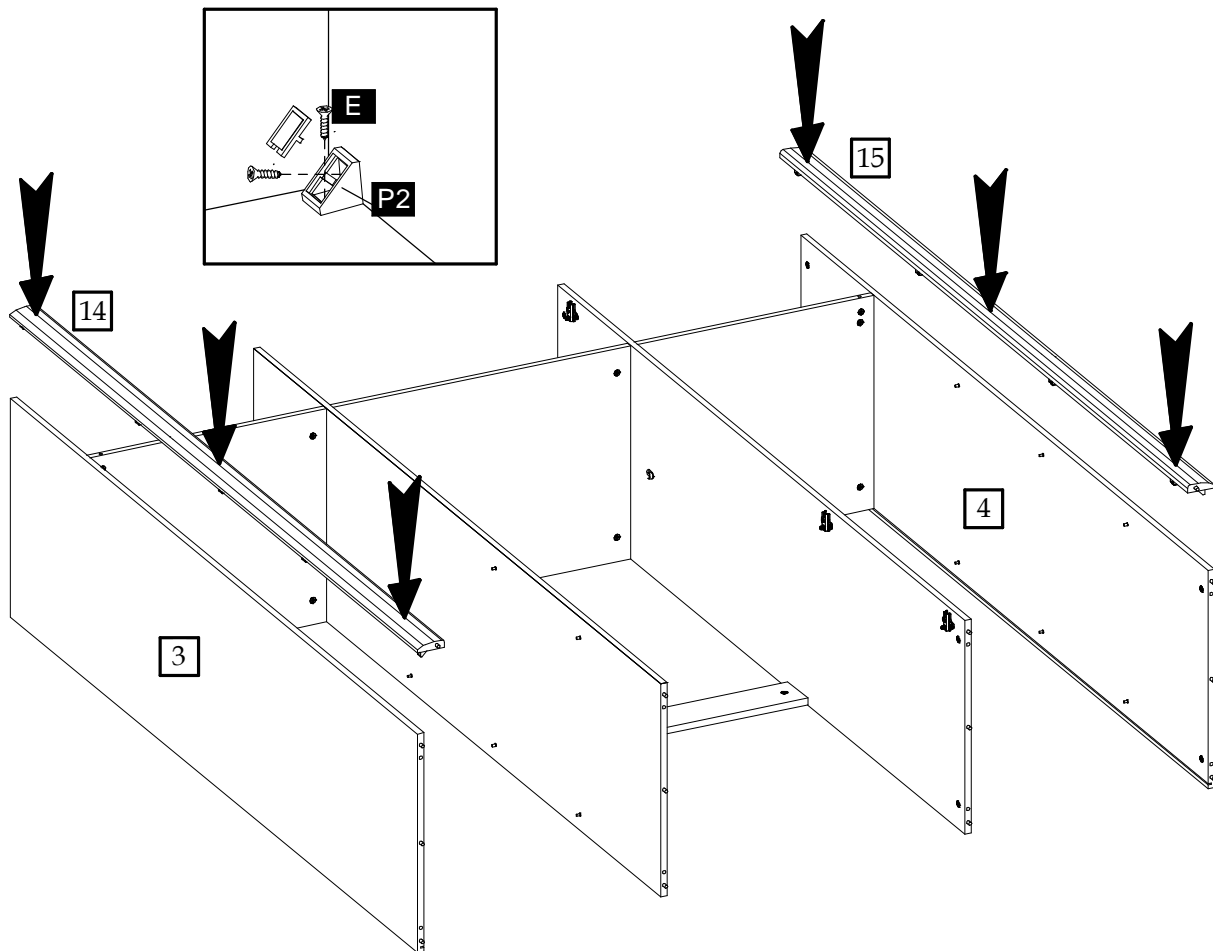

8

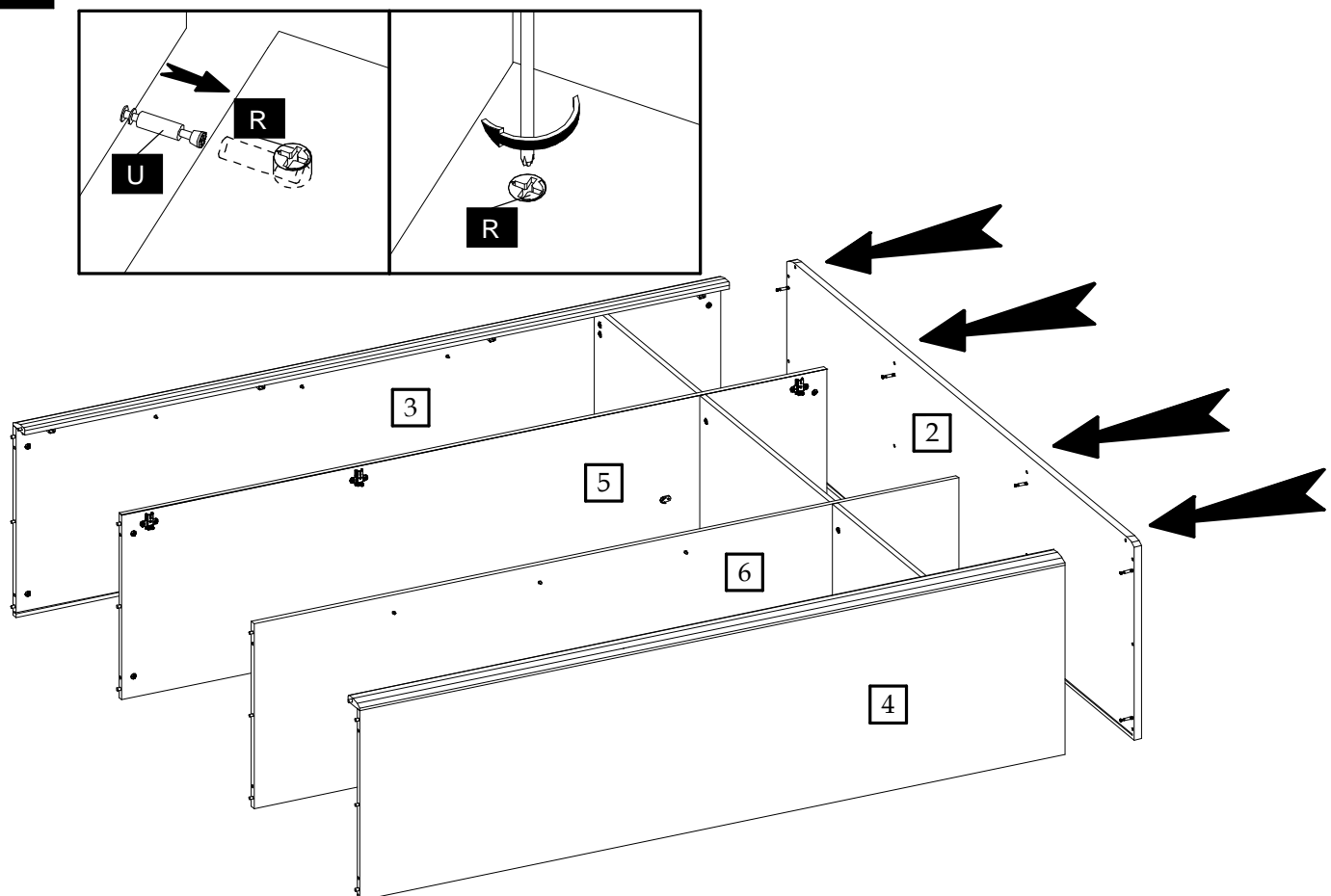

9

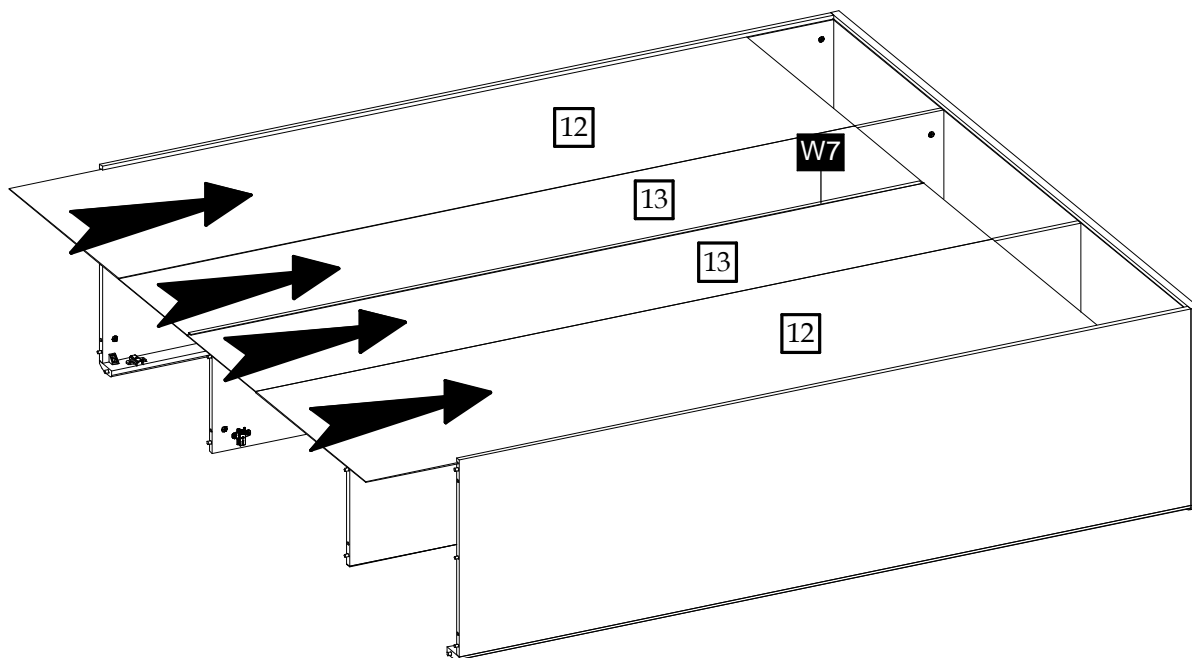

10

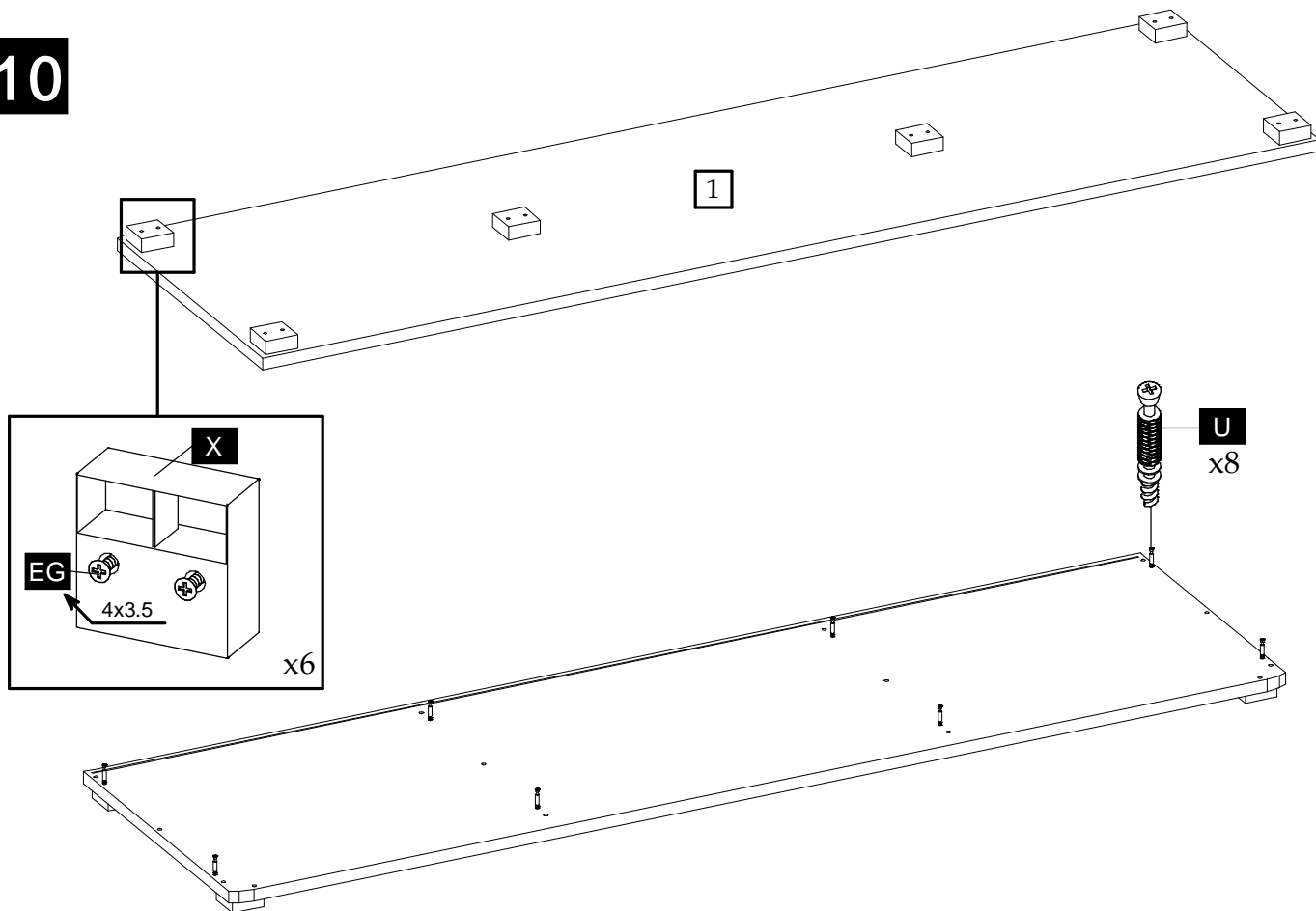

11

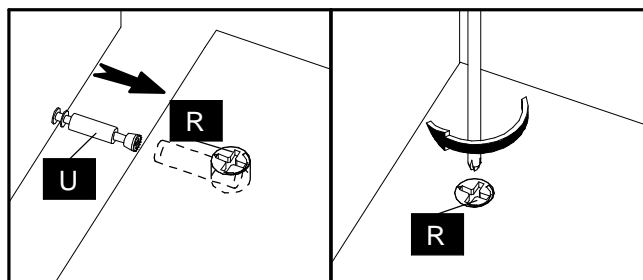
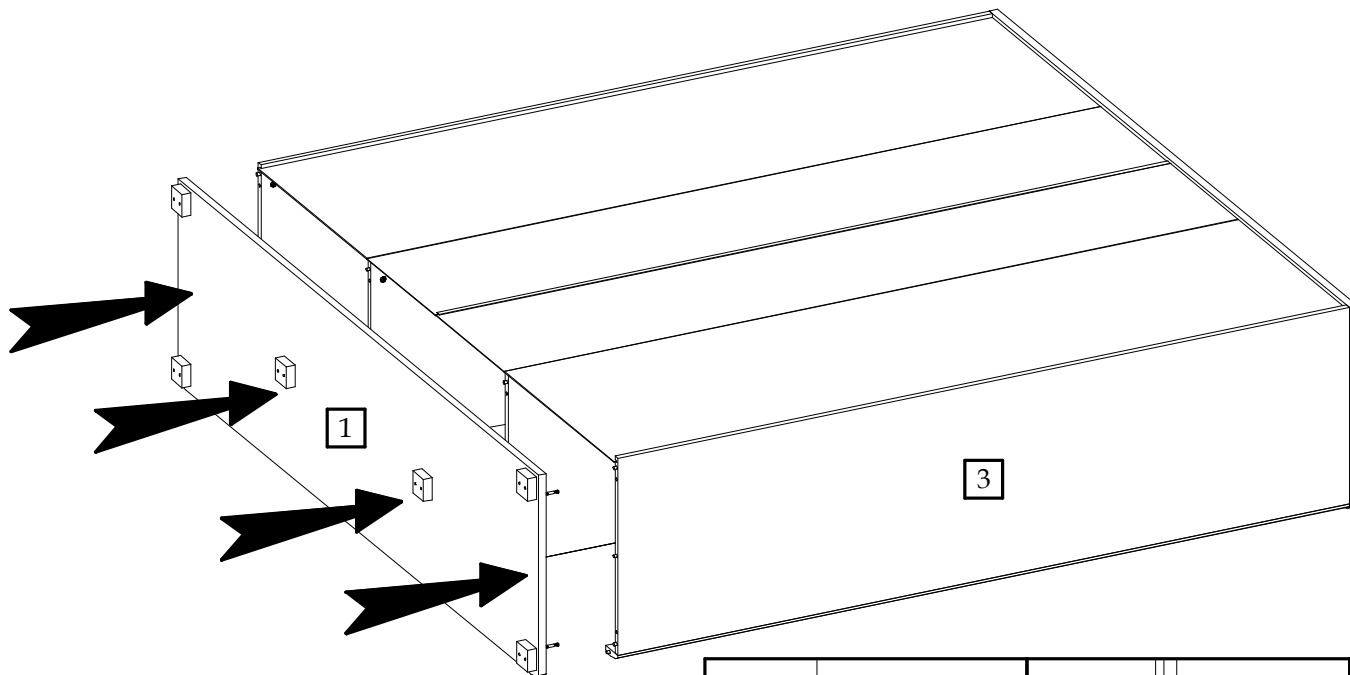

12

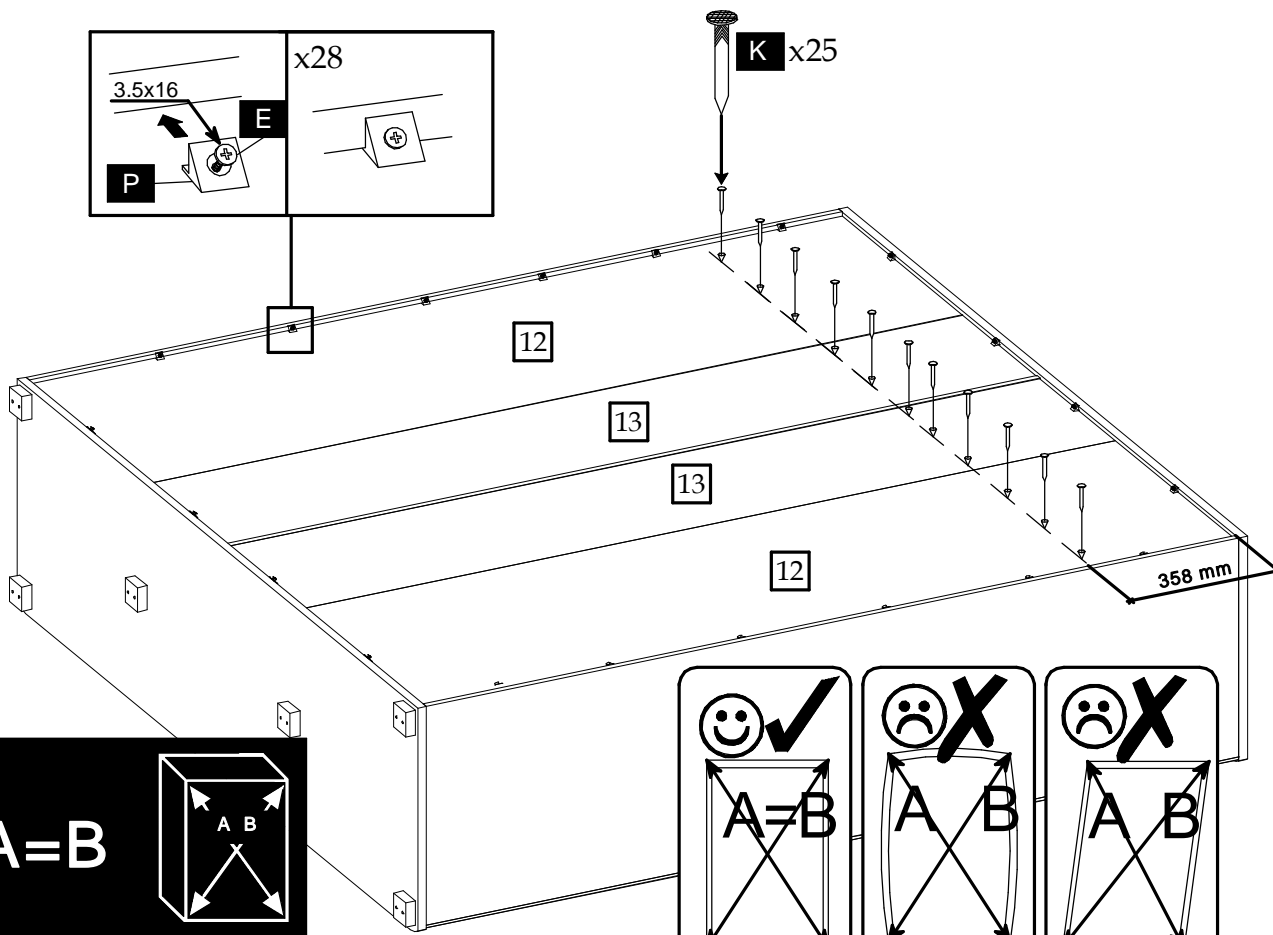
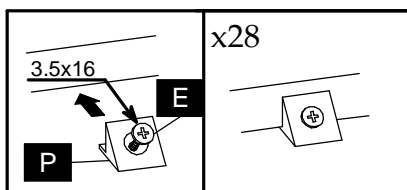

13

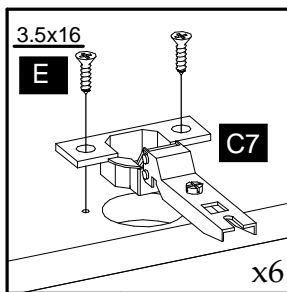
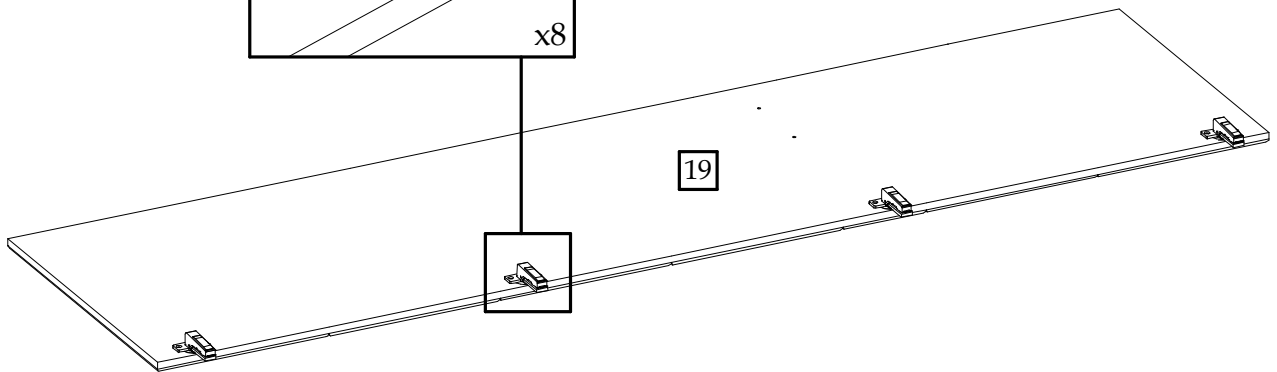
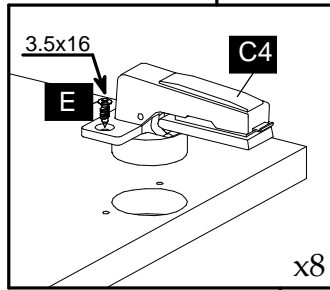
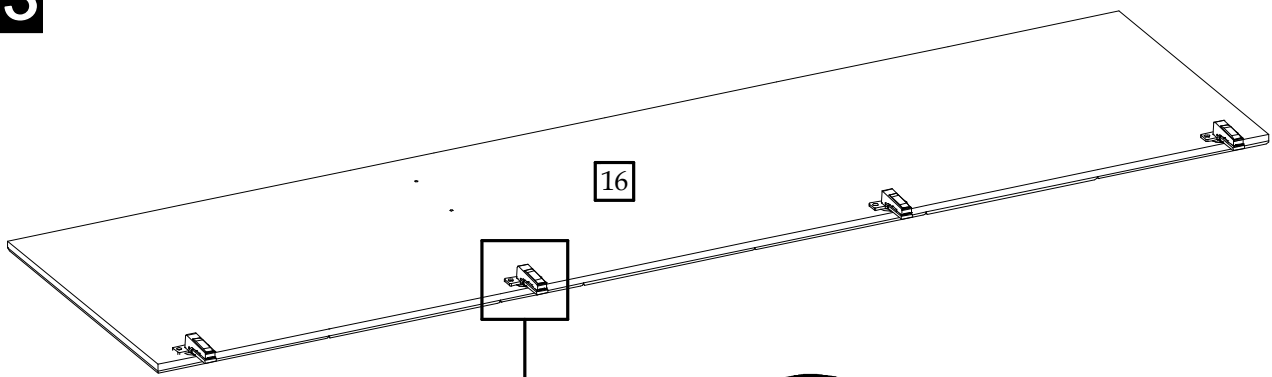

14

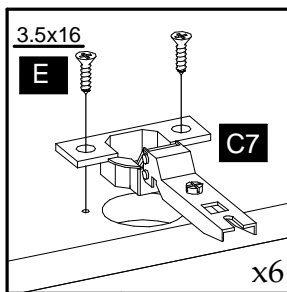
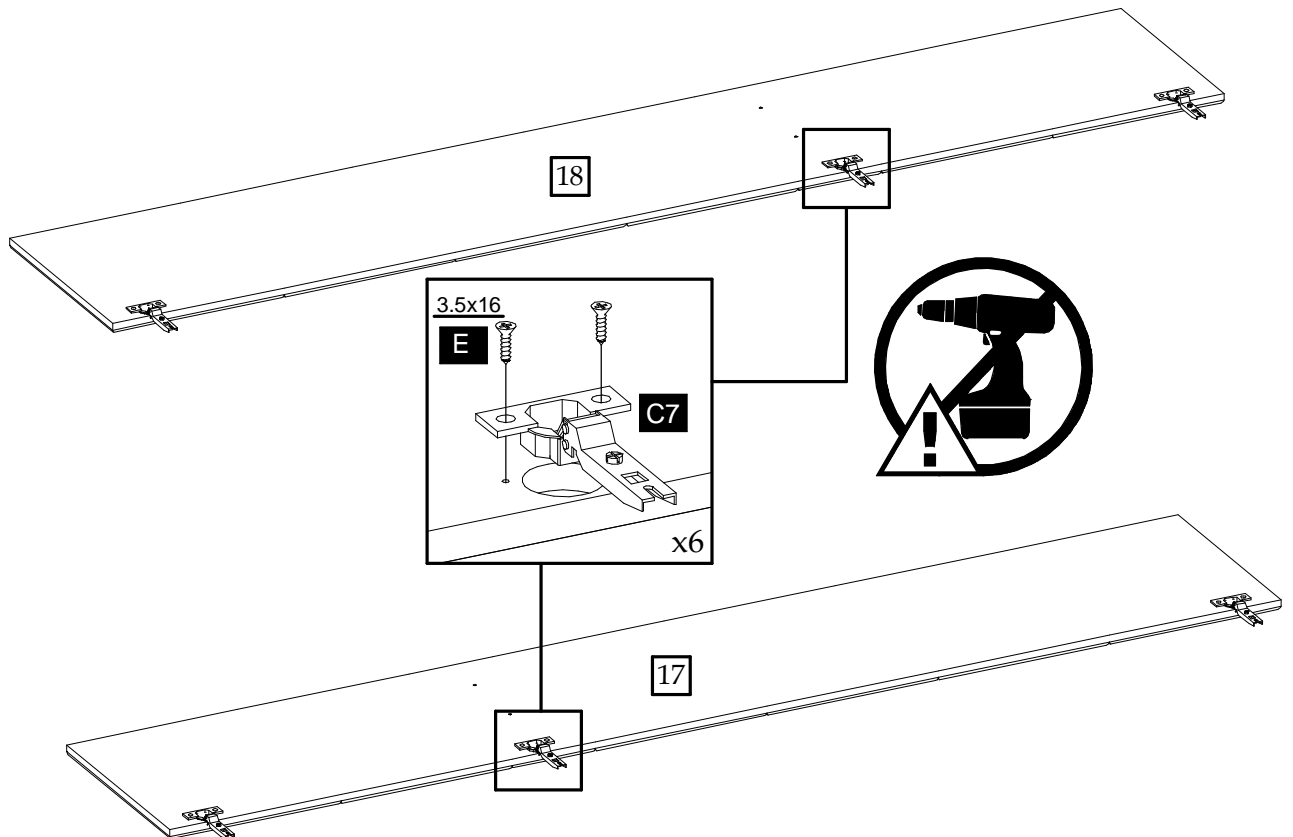

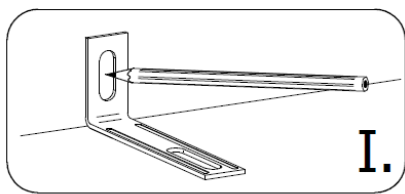

I.

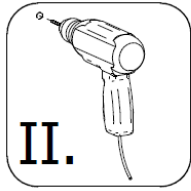

II.



III.

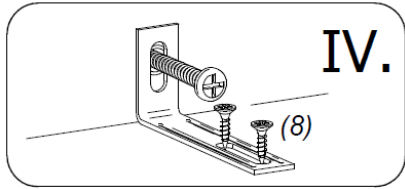

IV.

(8)

