

# MARTIN

## Typ R1

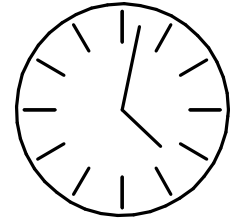

60 min

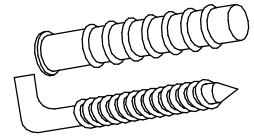
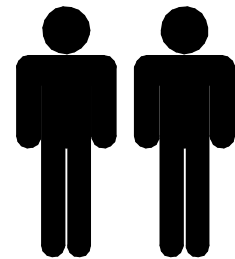

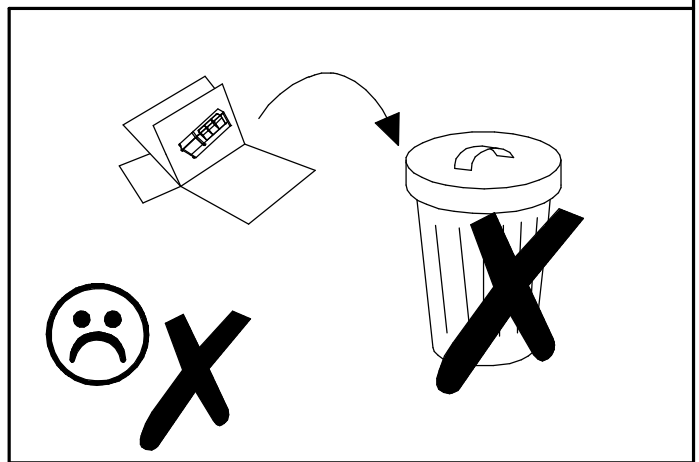
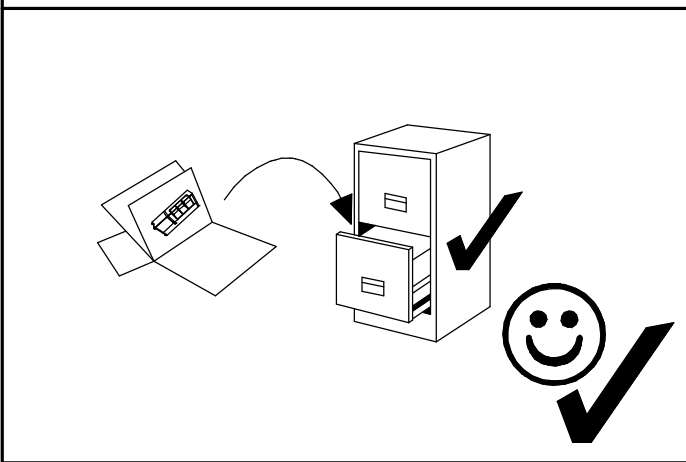

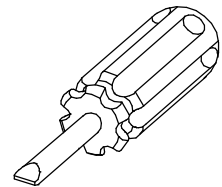
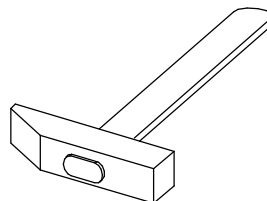
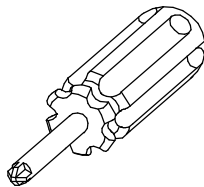
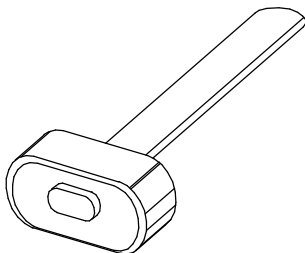
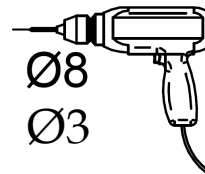
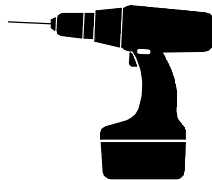
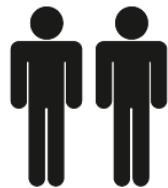
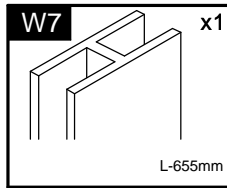
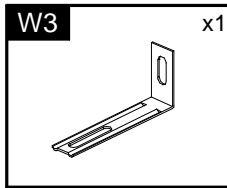
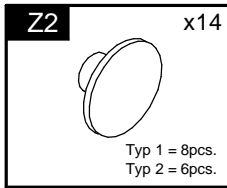
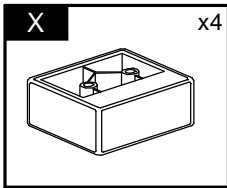
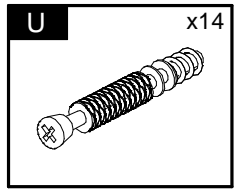
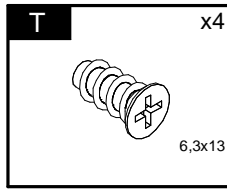
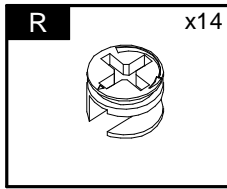
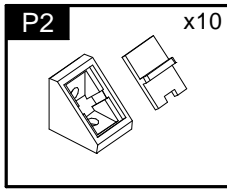
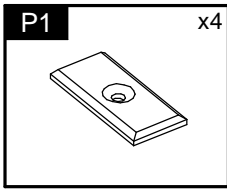
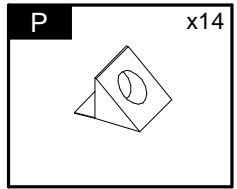
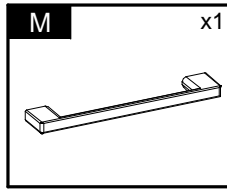
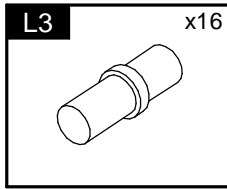
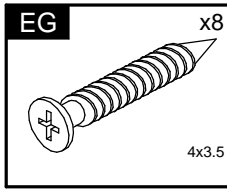
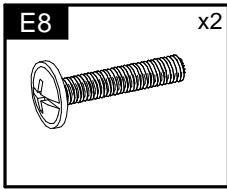
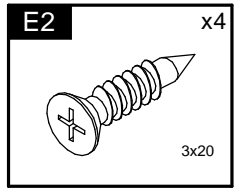
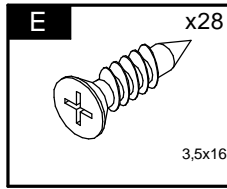
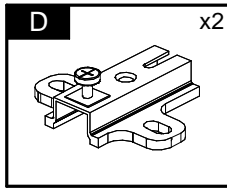
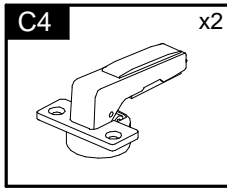
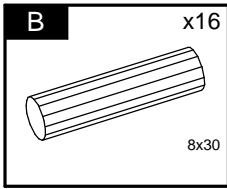
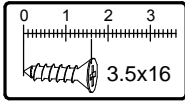
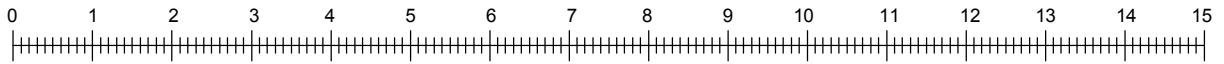

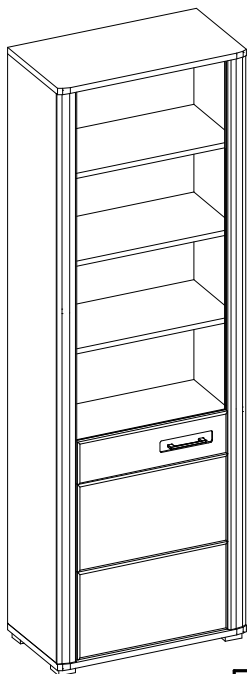

Element symbol	Measurements				Code	Paket
1	689	372	22	1	1001	1/2
2	689	372	22	1	1002	1/2
3	2036	350	16	1	1003	1/2
4	2036	350	16	1	1004	1/2
5	655	336.5	16	1	1030	1/2
6	655	330	16	4	N/A	1/2
7	744	667	2.5	1	N/A	2/2
8	663	667	2.5	1	N/A	2/2
9	640	667	2.5	1	N/A	2/2
10	2036	68	19	1	1017	1/2
11	2036	68	19	1	1018	1/2
12	778	547	19	1	3010	2/2

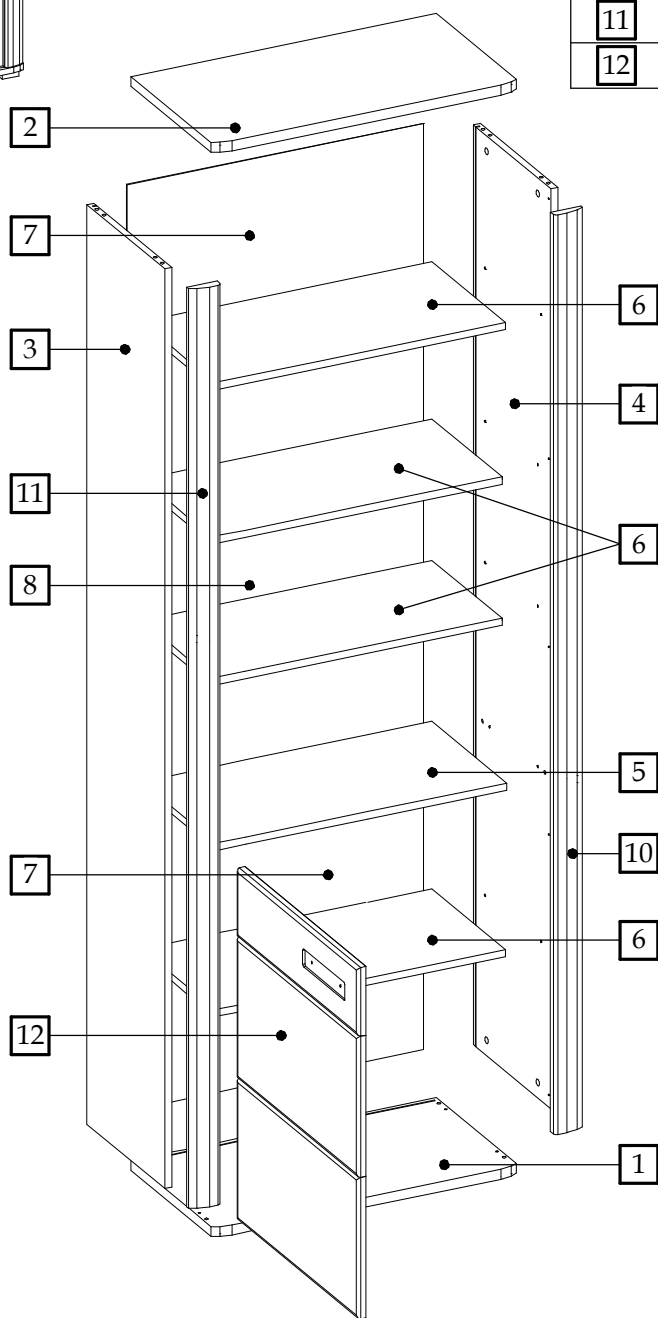



1

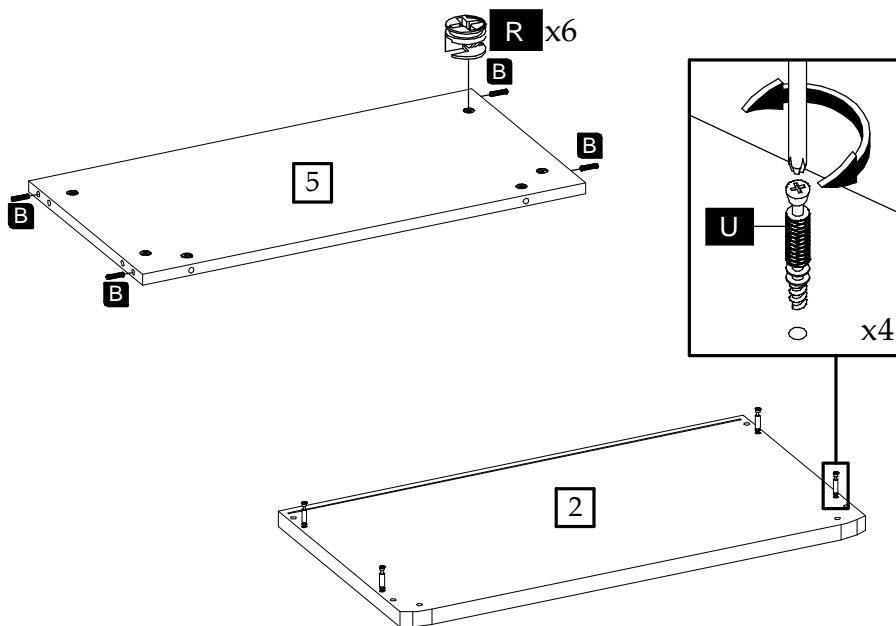
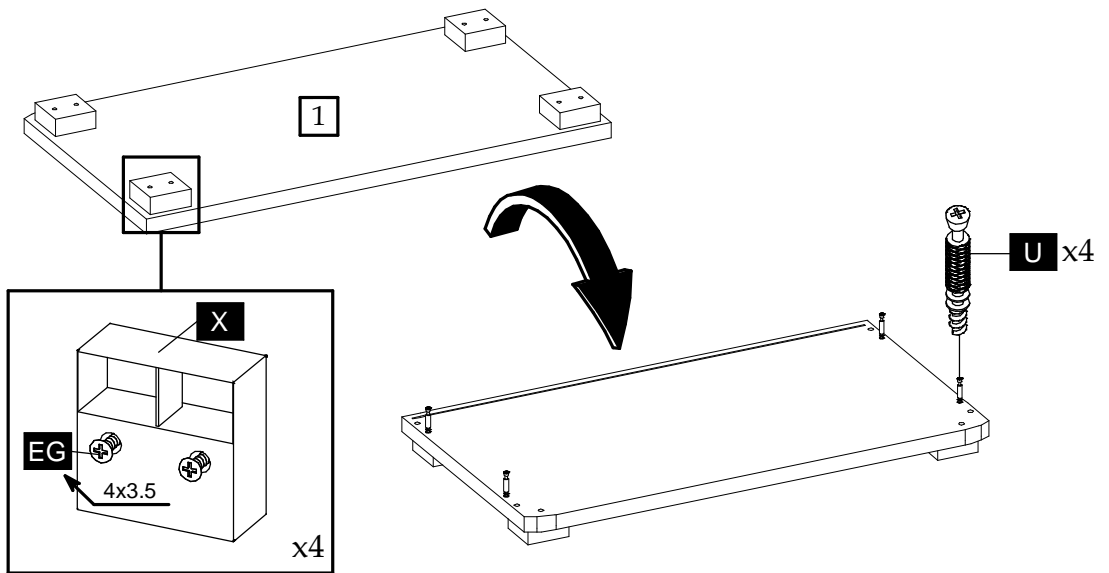

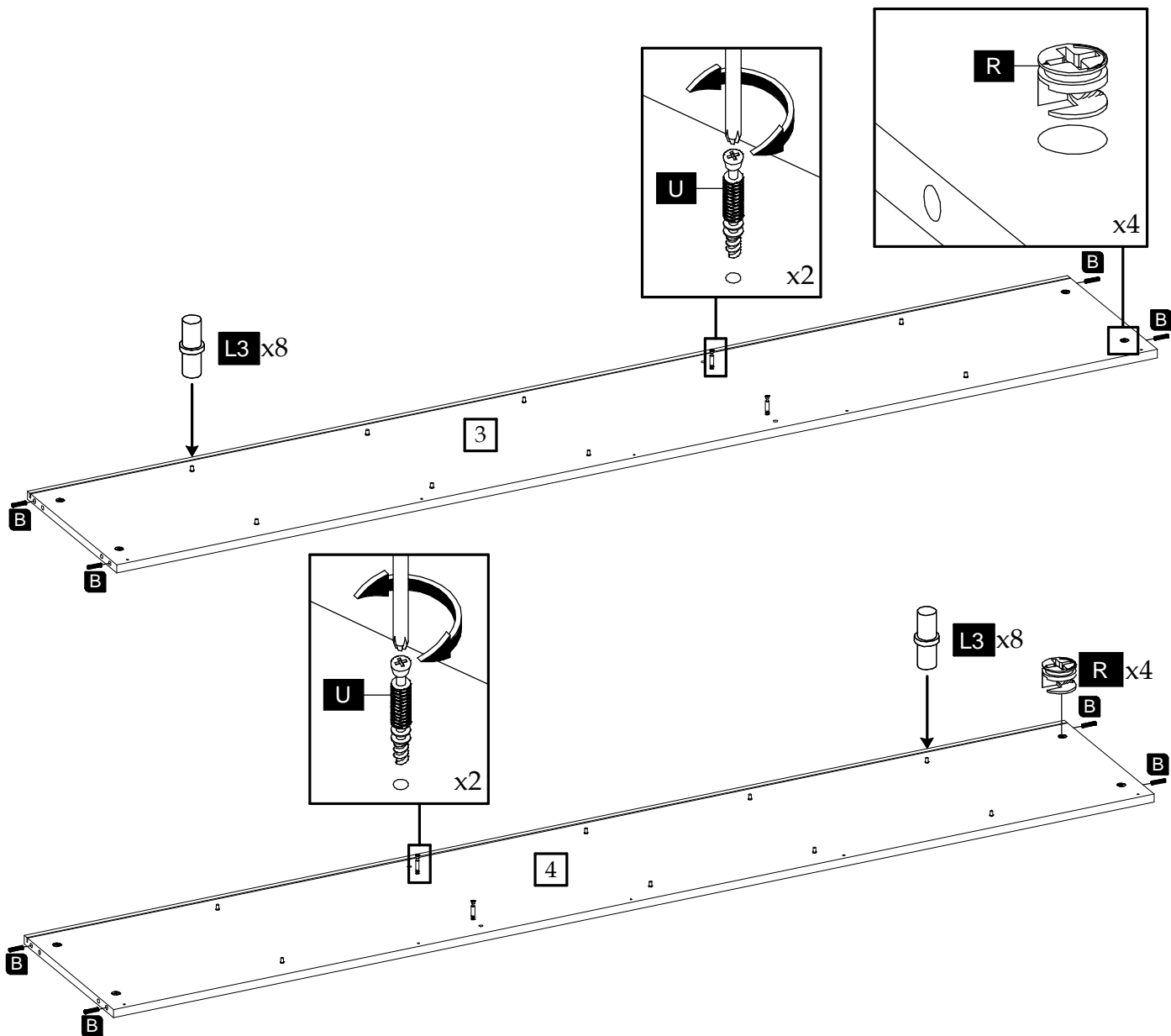

3

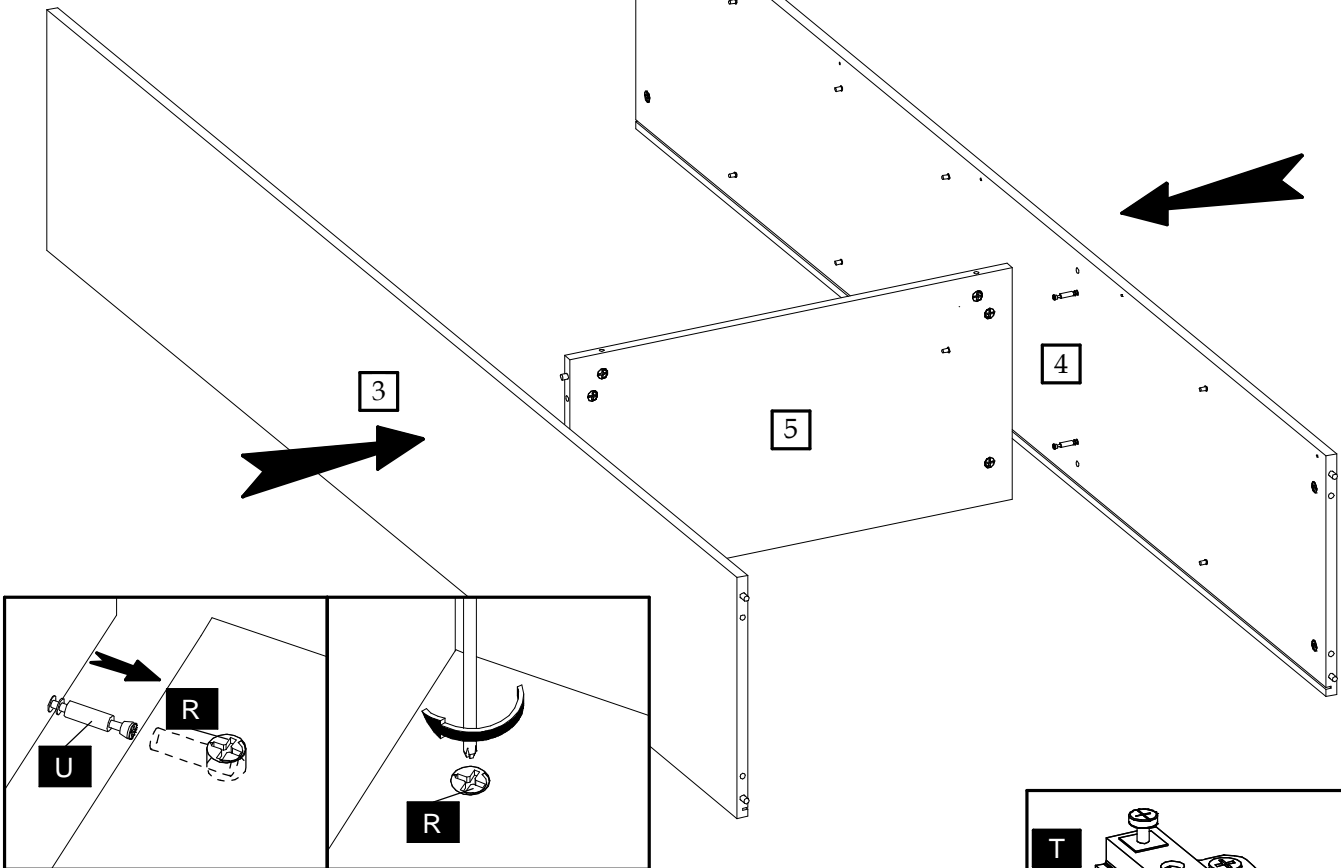

4

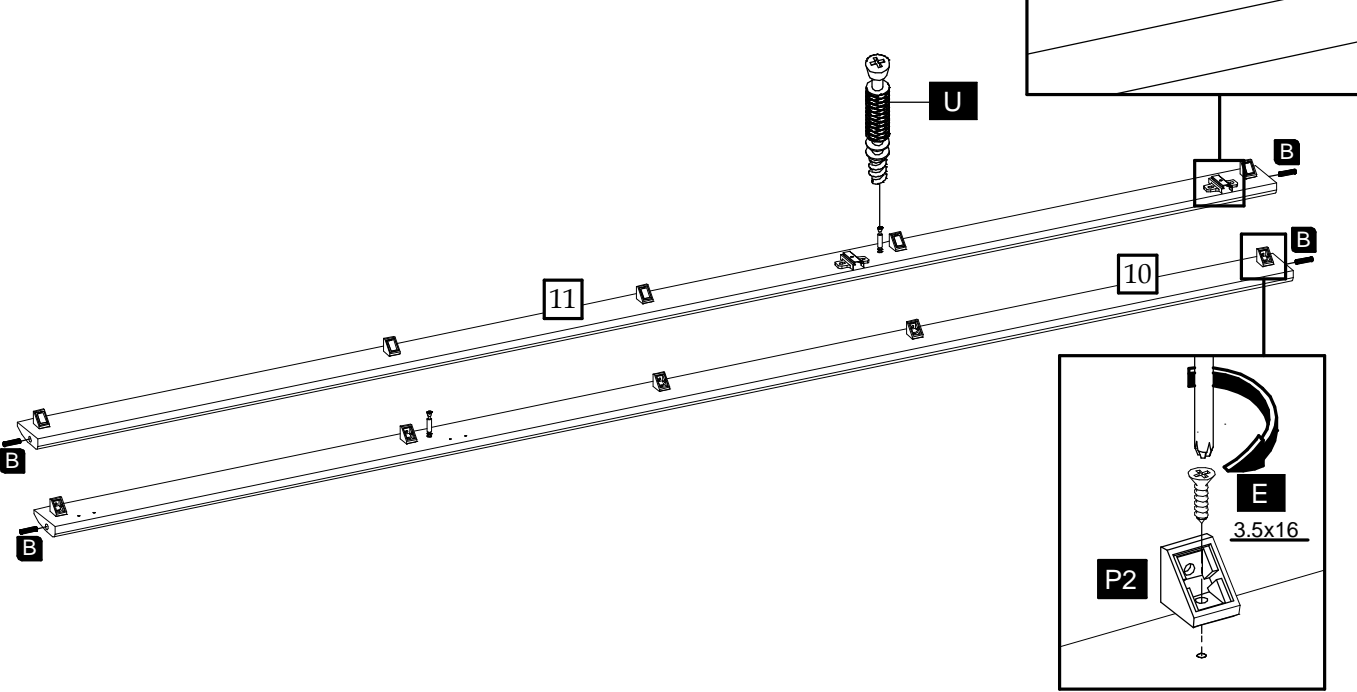

5

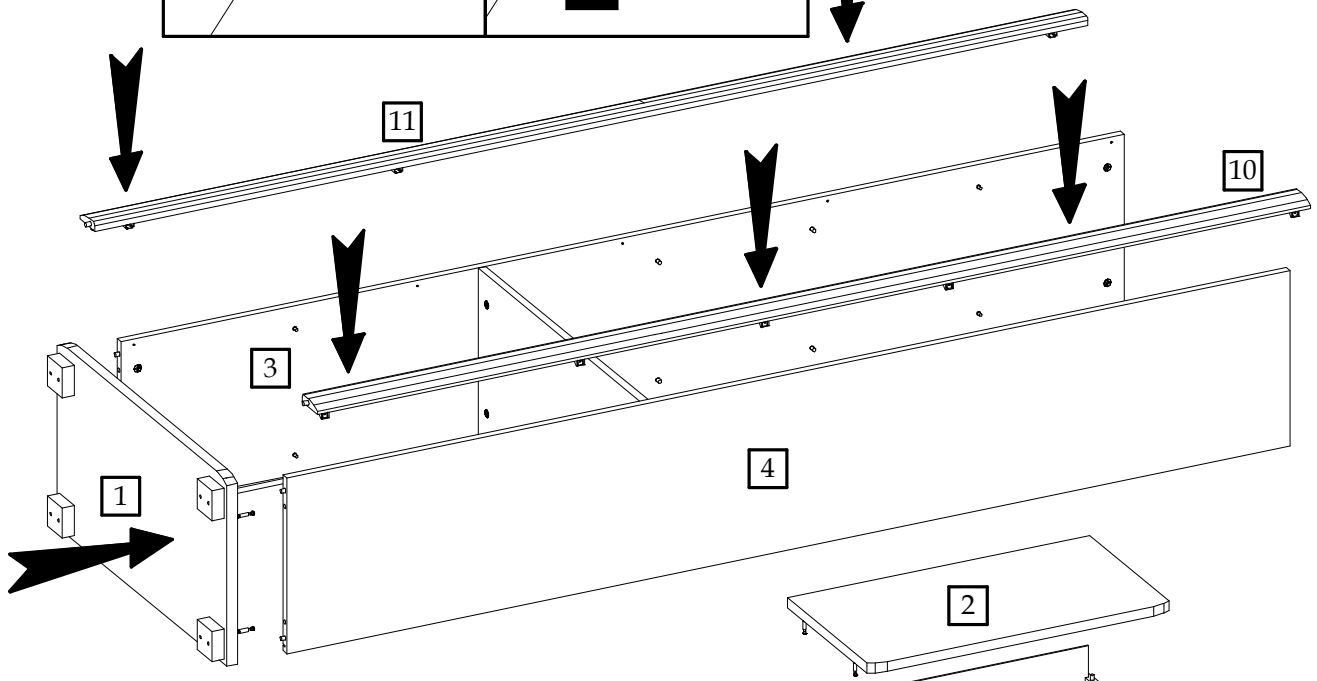
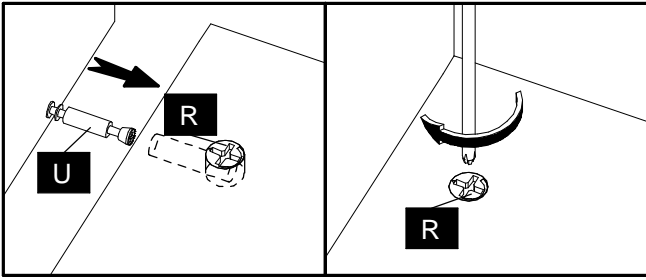

6

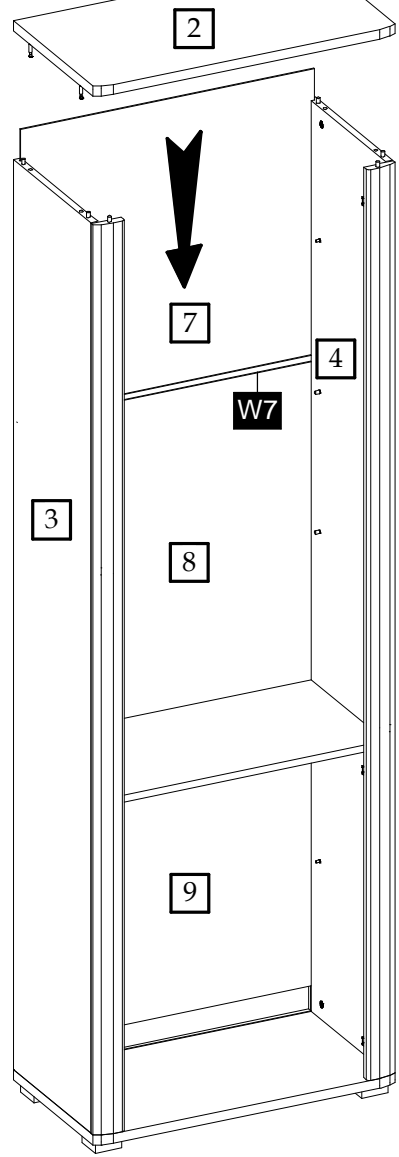
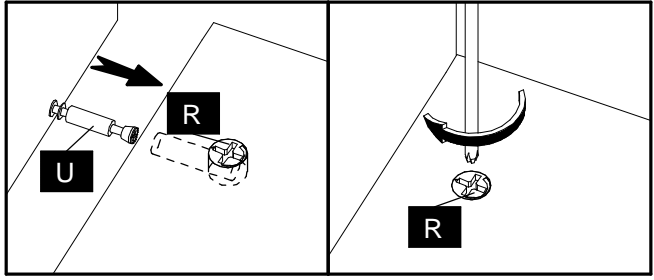
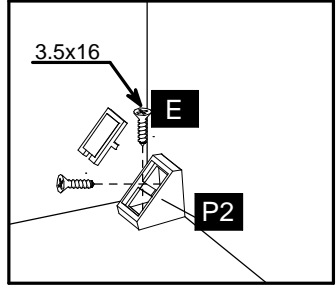



7

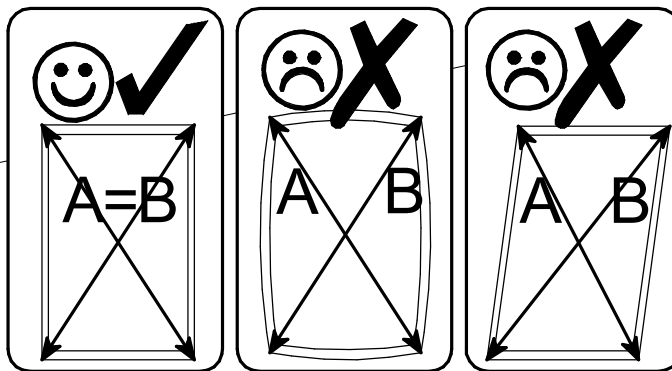
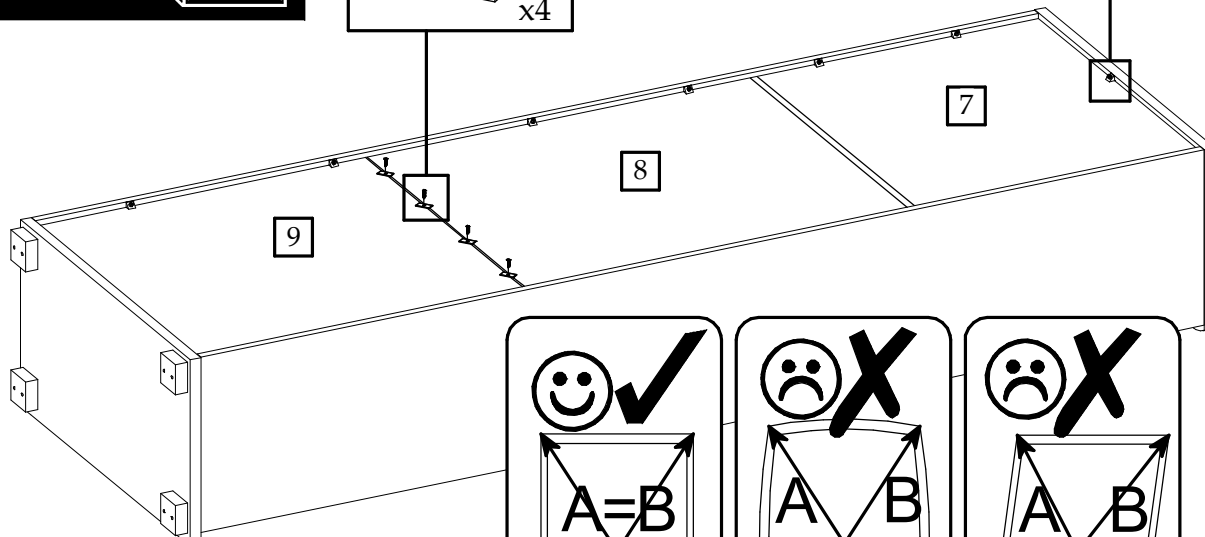
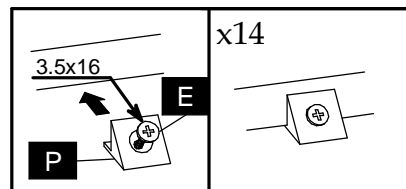
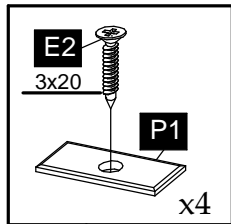
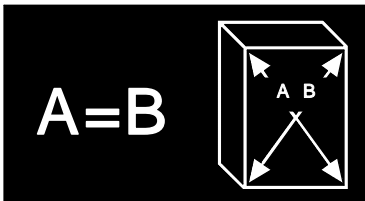

8

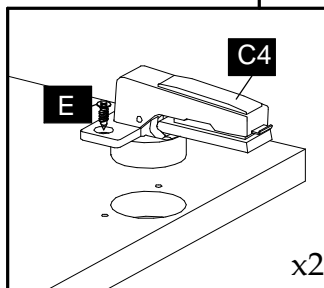
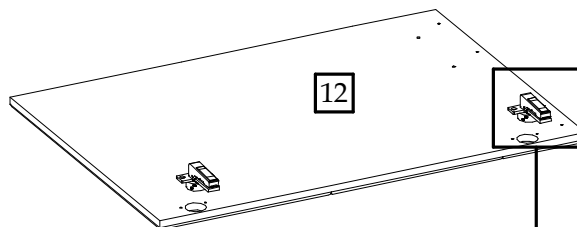

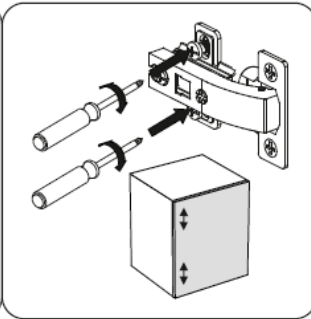
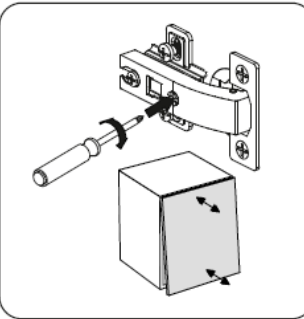
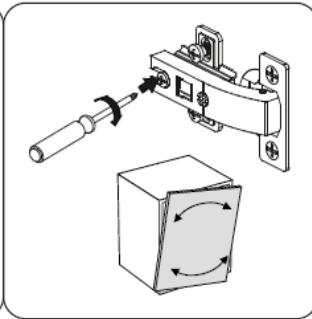
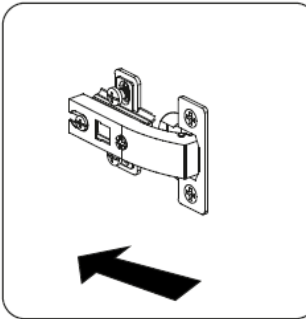
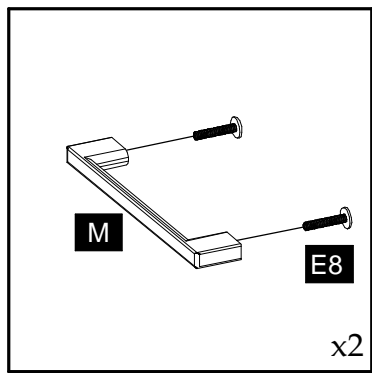
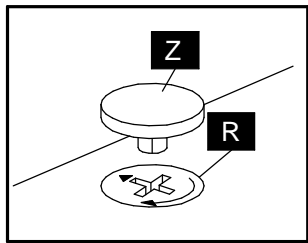
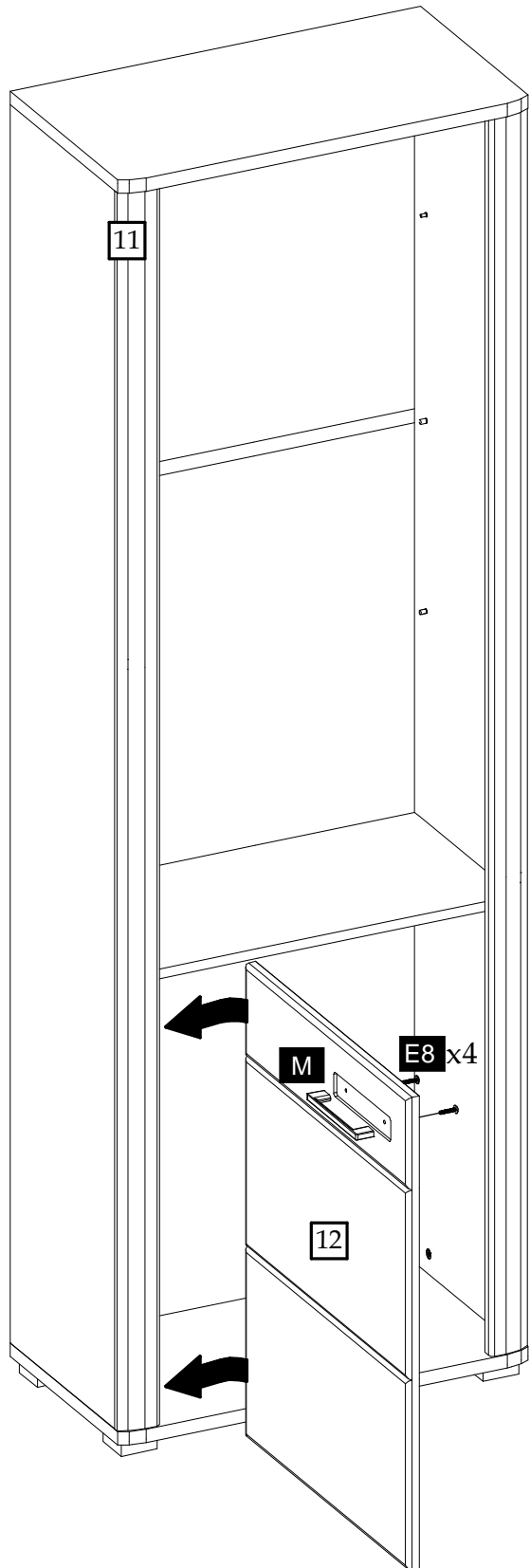

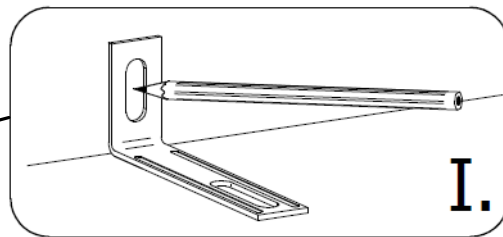
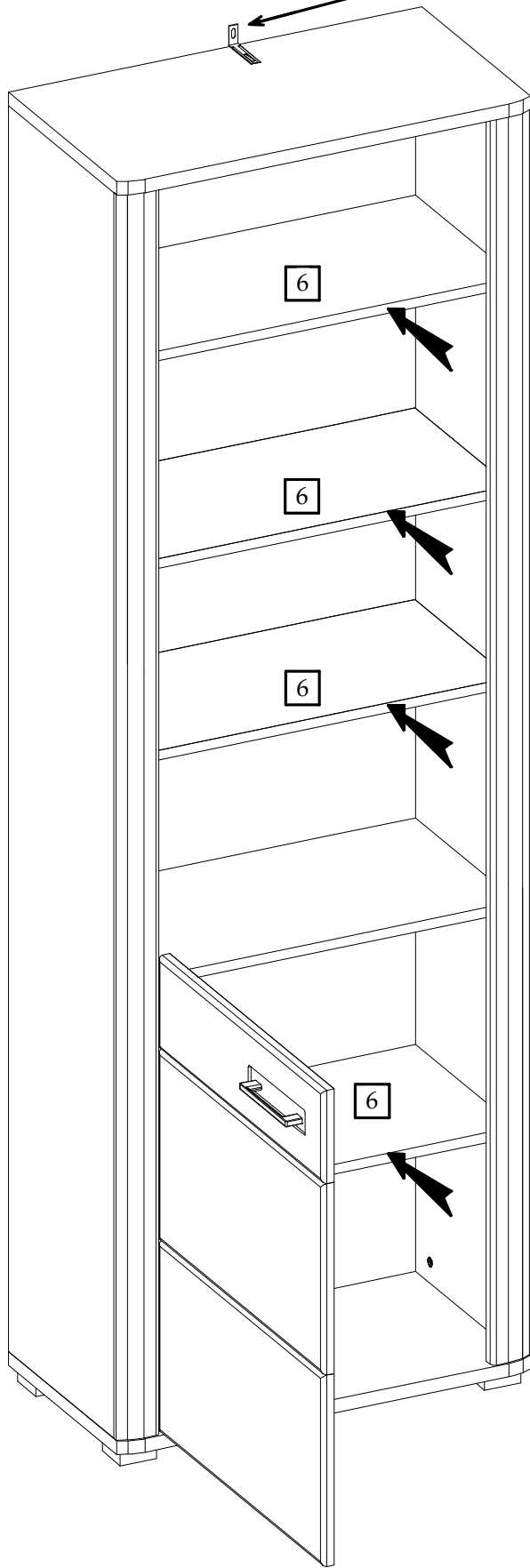

I.

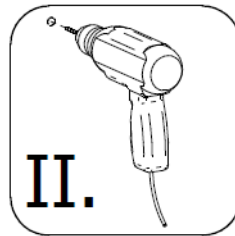

II.

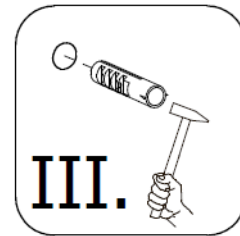

III.

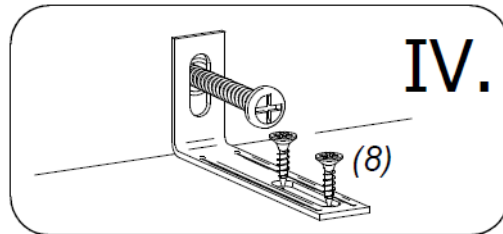

IV.

