

# MARTIN

## Typ V1

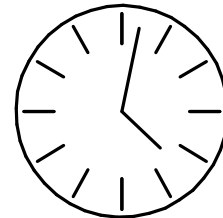

60 min

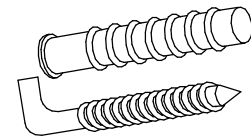
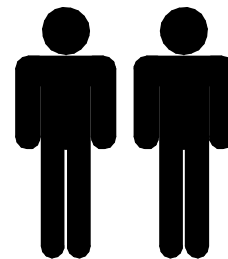



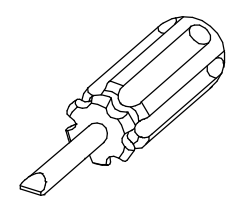
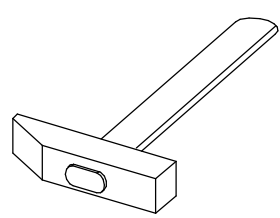
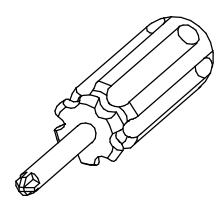
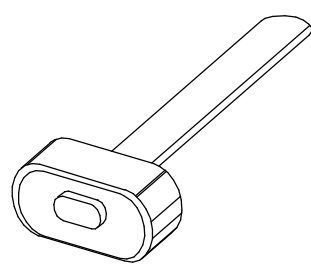
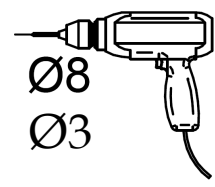
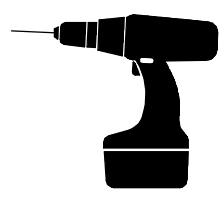
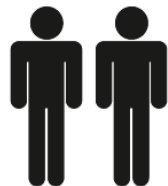
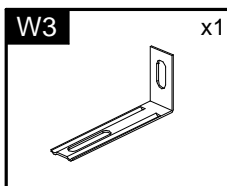
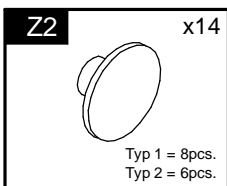
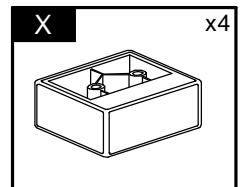
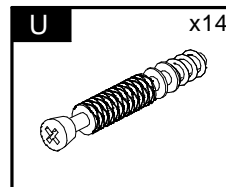
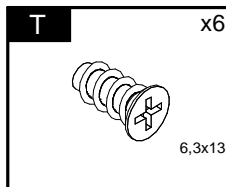
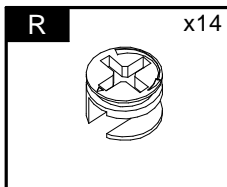
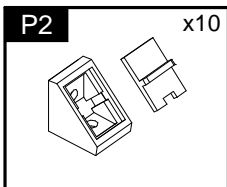
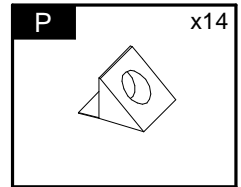
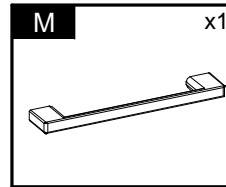
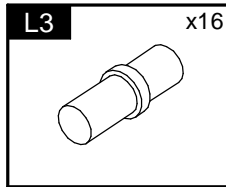
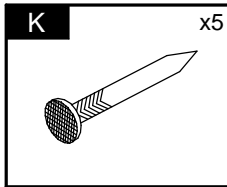
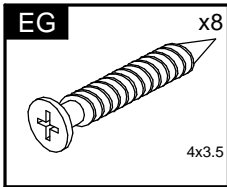
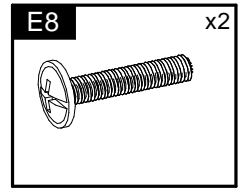
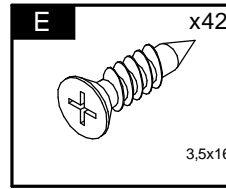
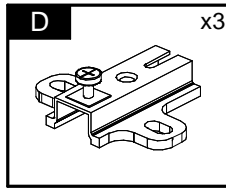
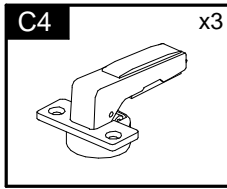
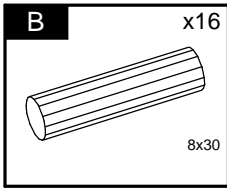
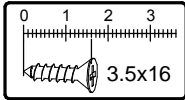

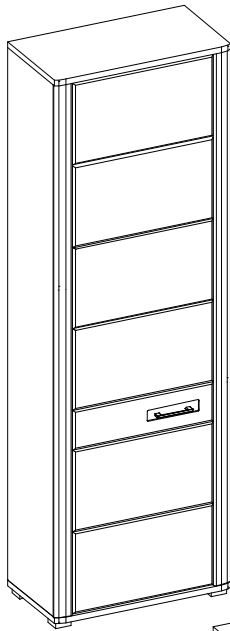

| Element symbol | Measurements |       |     |   | Code | Paket |
|----------------|--------------|-------|-----|---|------|-------|
| 1              | 689          | 372   | 22  | 1 | 1001 | 1/2   |
| 2              | 689          | 372   | 22  | 1 | 1002 | 1/2   |
| 3              | 2036         | 350   | 16  | 1 | 1003 | 1/2   |
| 4              | 2036         | 350   | 16  | 1 | 1004 | 1/2   |
| 5              | 655          | 336.5 | 16  | 1 | 1030 | 1/2   |
| 6              | 655          | 330   | 16  | 4 | N/A  | 1/2   |
| 7              | 2048         | 667   | 2.5 | 1 | N/A  | 2/2   |
| 8              | 2036         | 68    | 19  | 1 | 1017 | 1/2   |
| 9              | 2036         | 68    | 19  | 1 | 1018 | 1/2   |
| 10             | 2031         | 547   | 19  | 1 | 3010 | 2/2   |

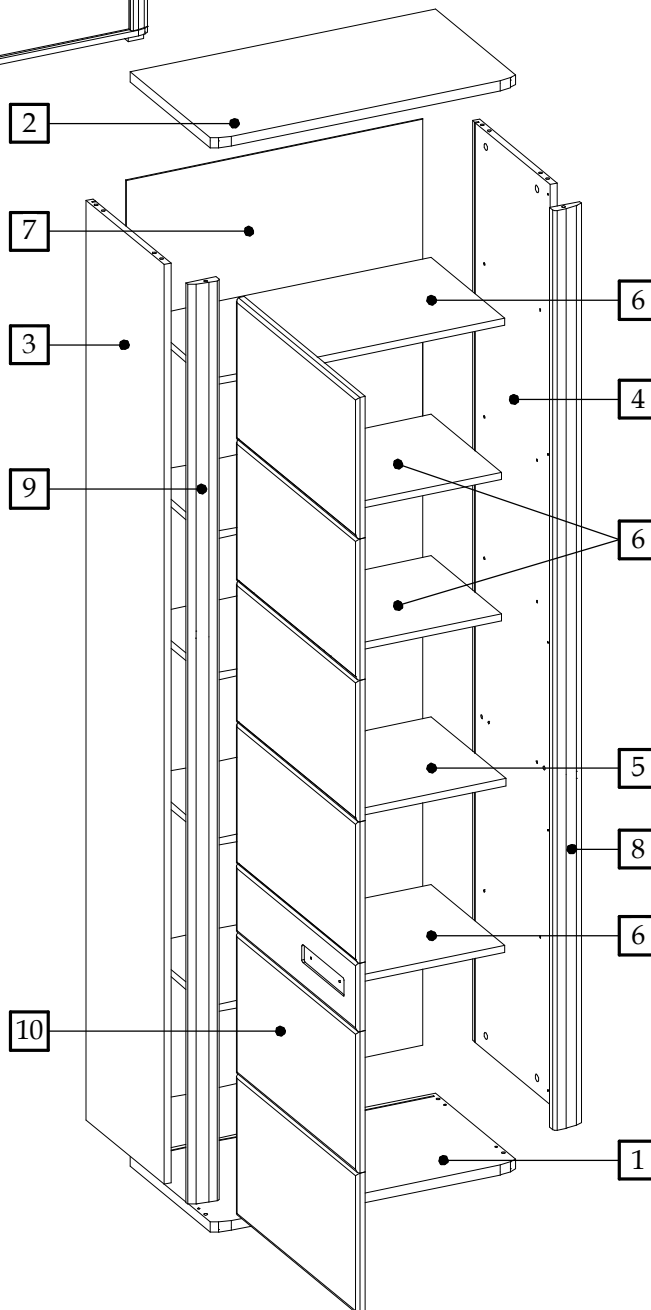



1

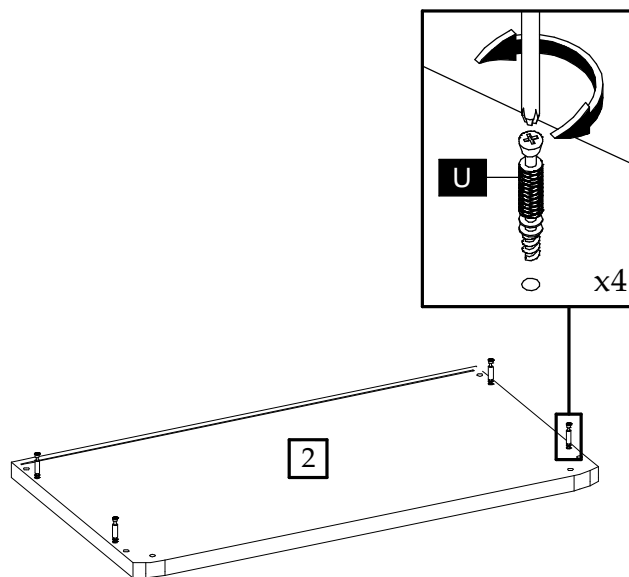
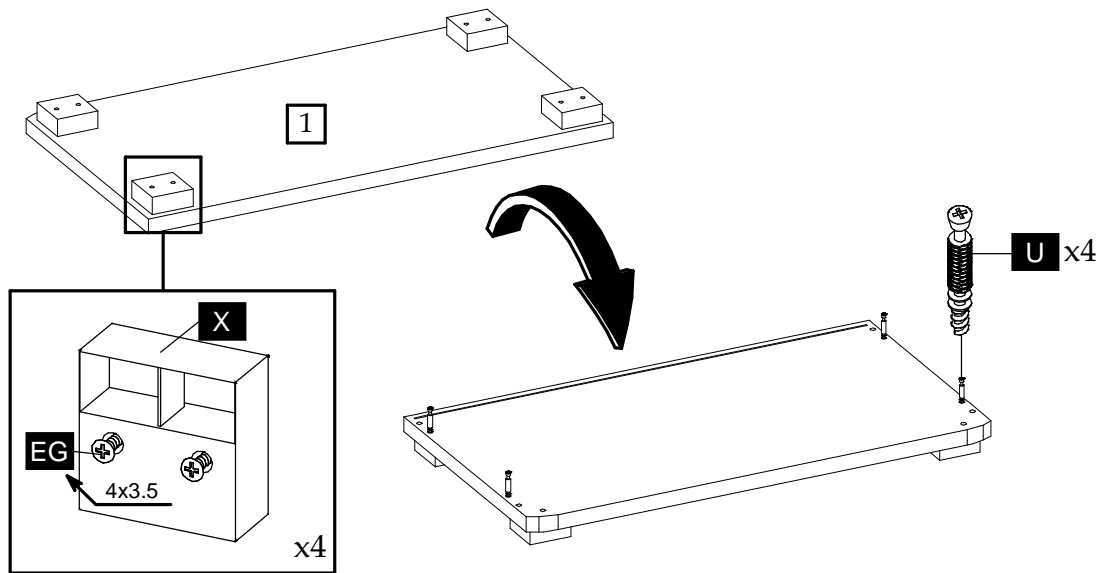

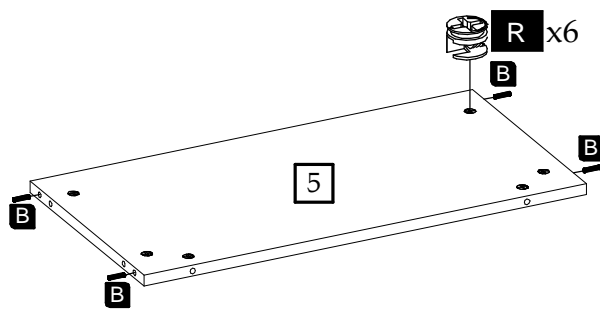
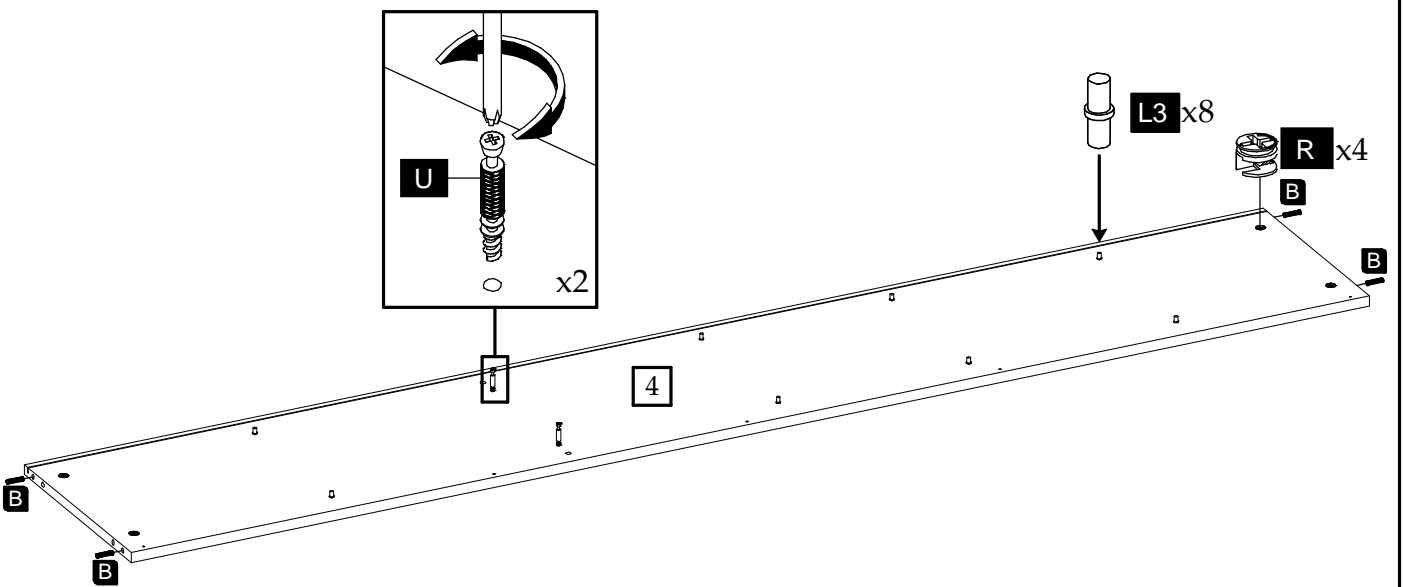
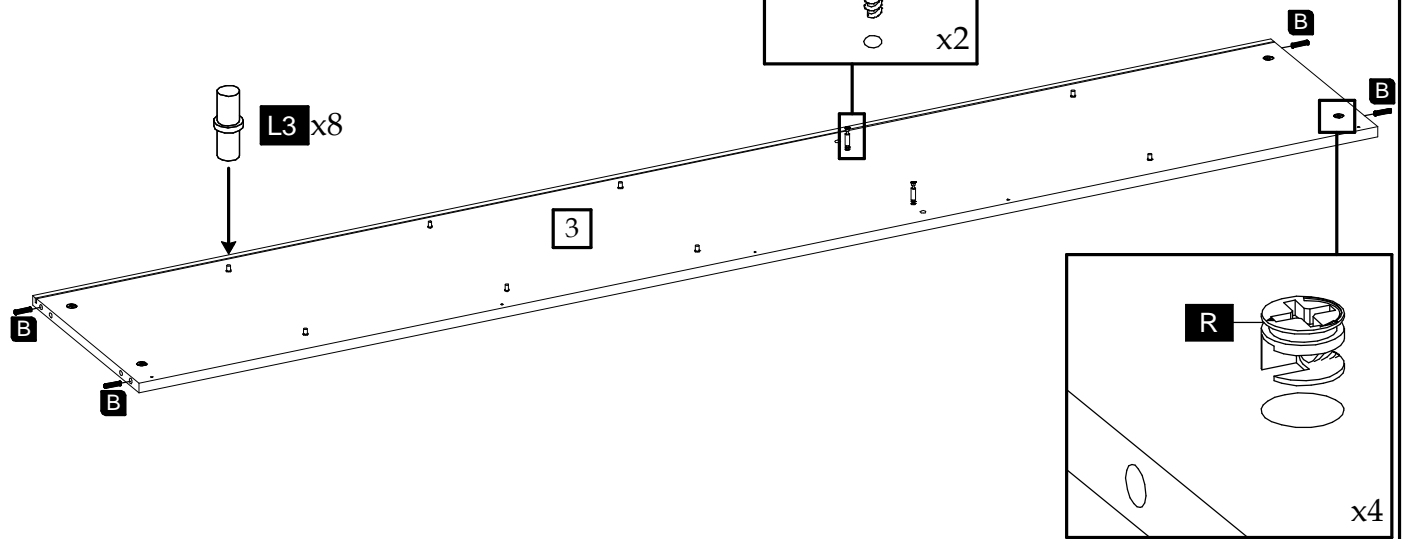

3

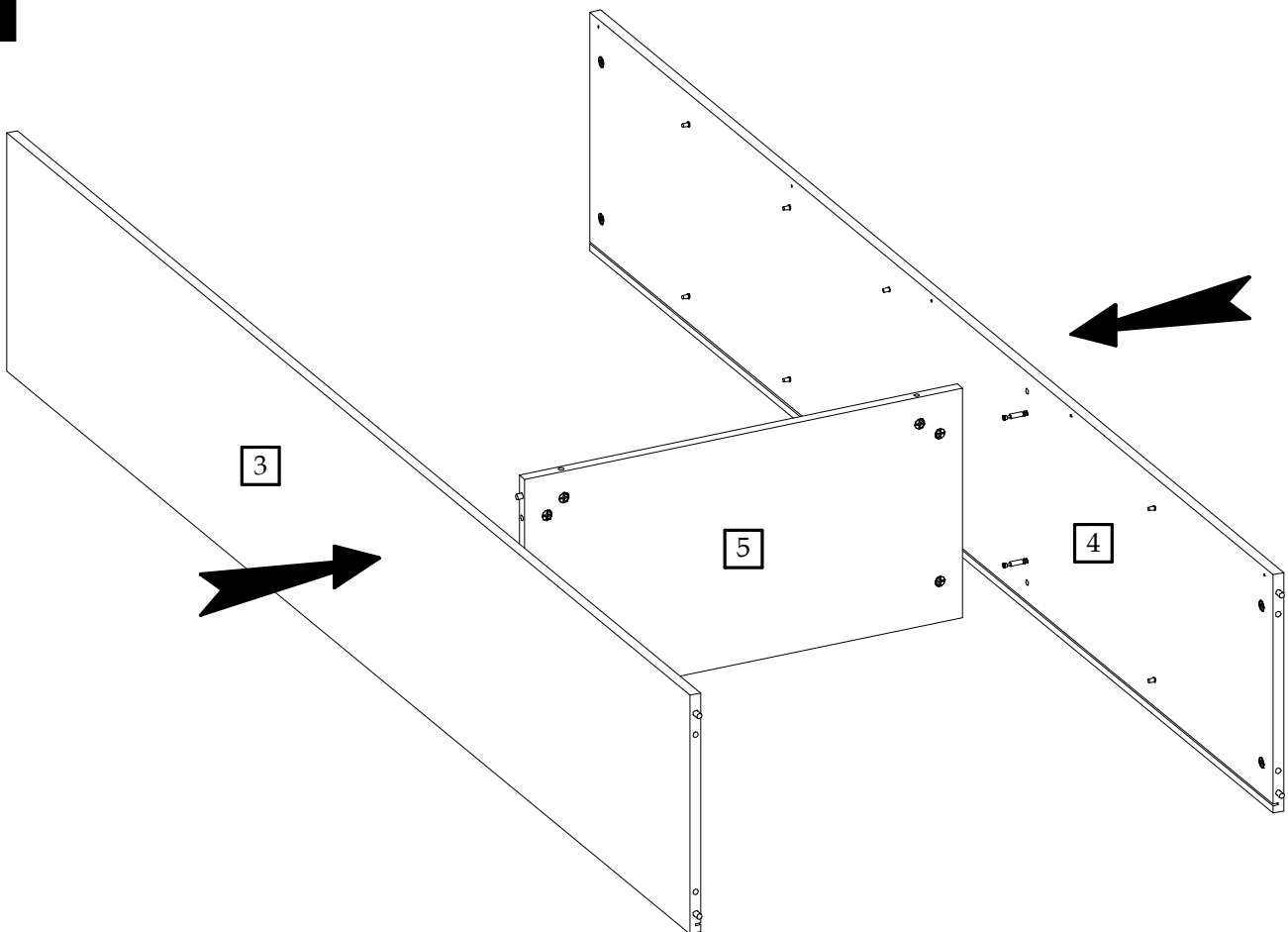

4

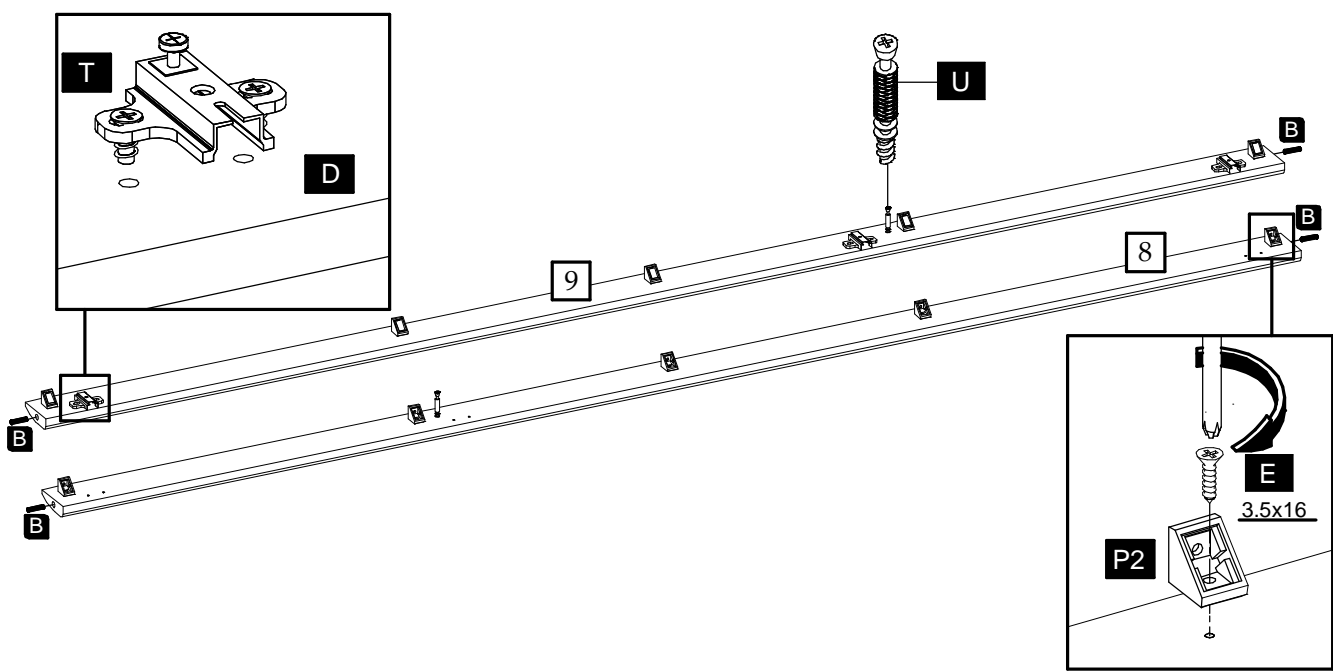

5

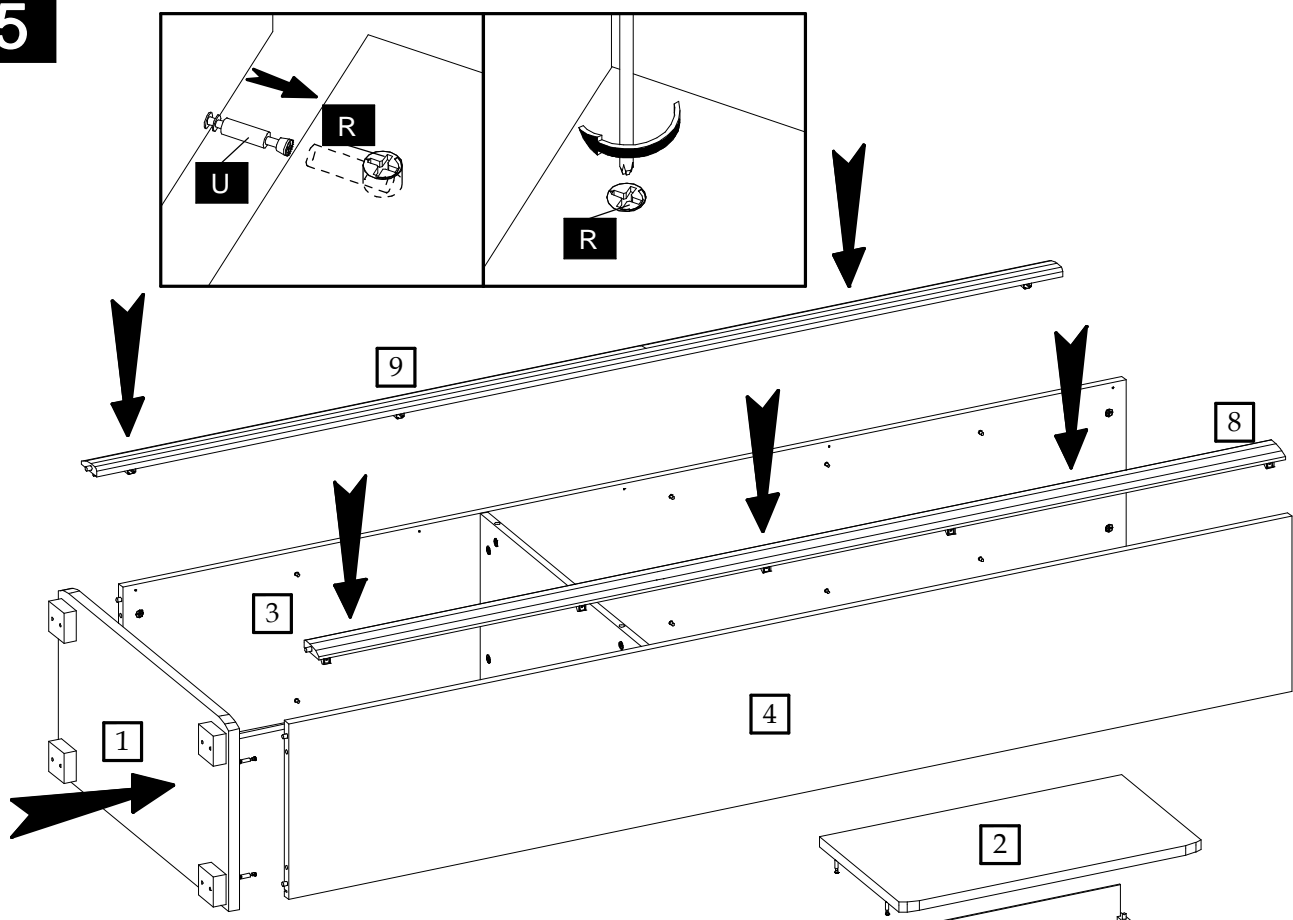

6

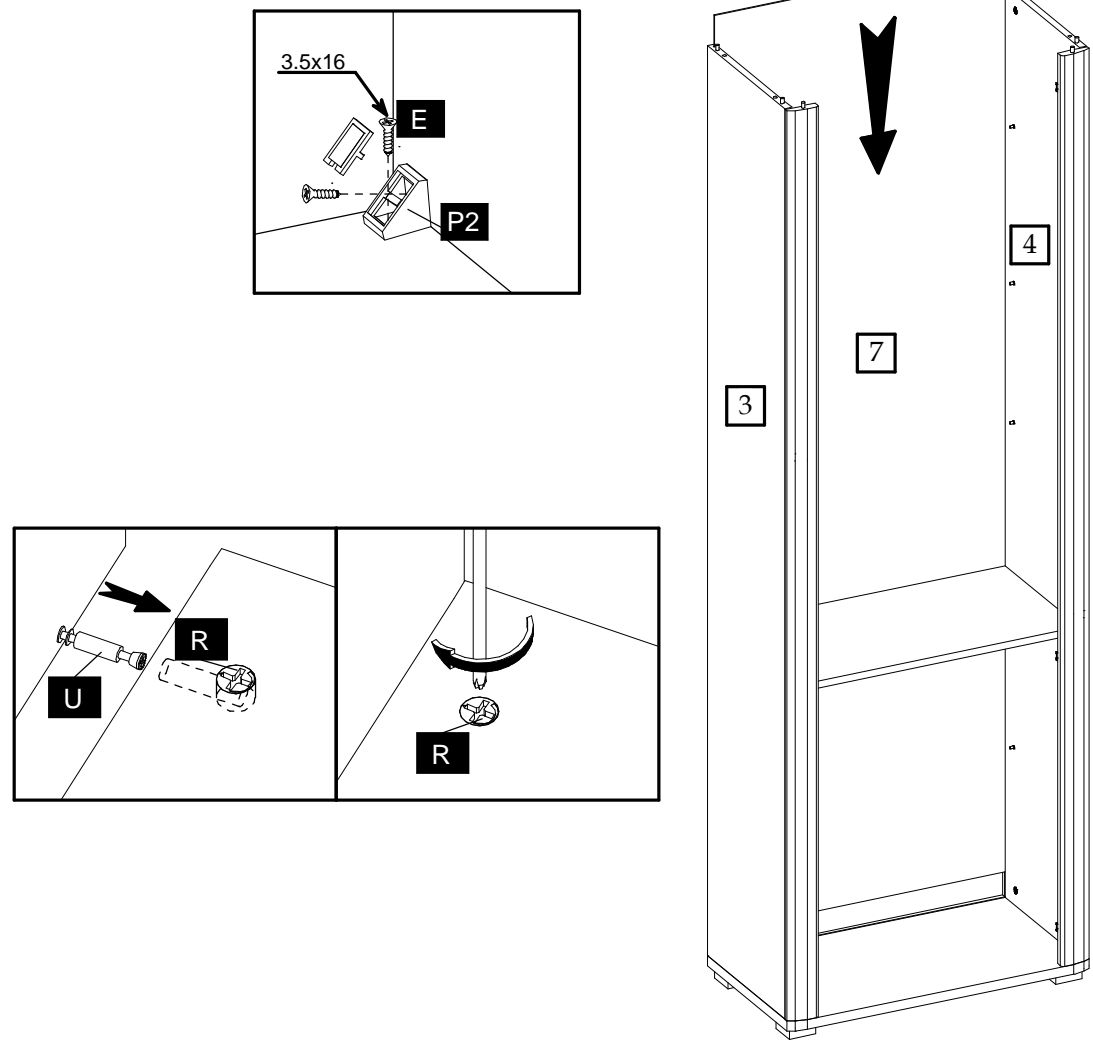



7

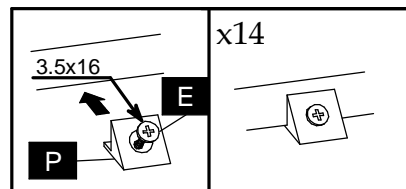
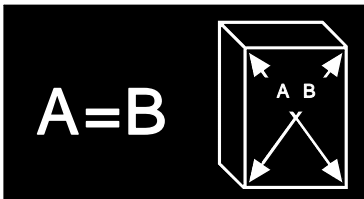

x14

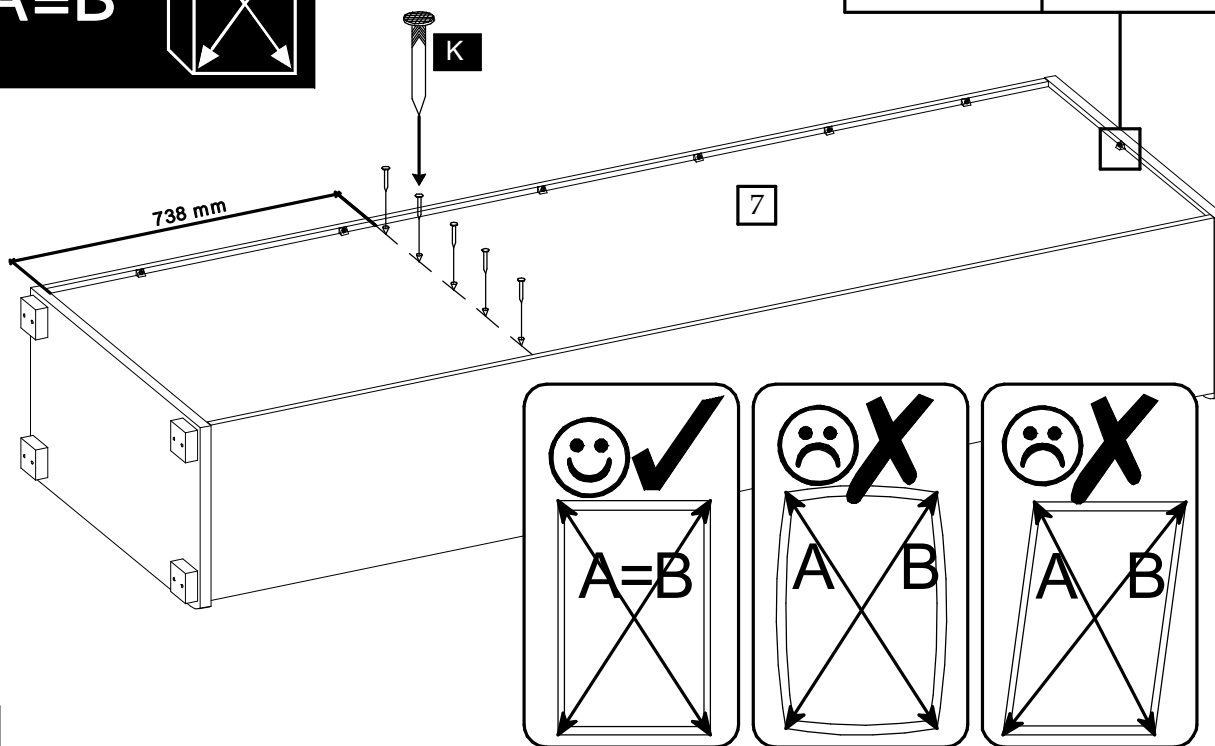

8

