

MoNe

Typ R

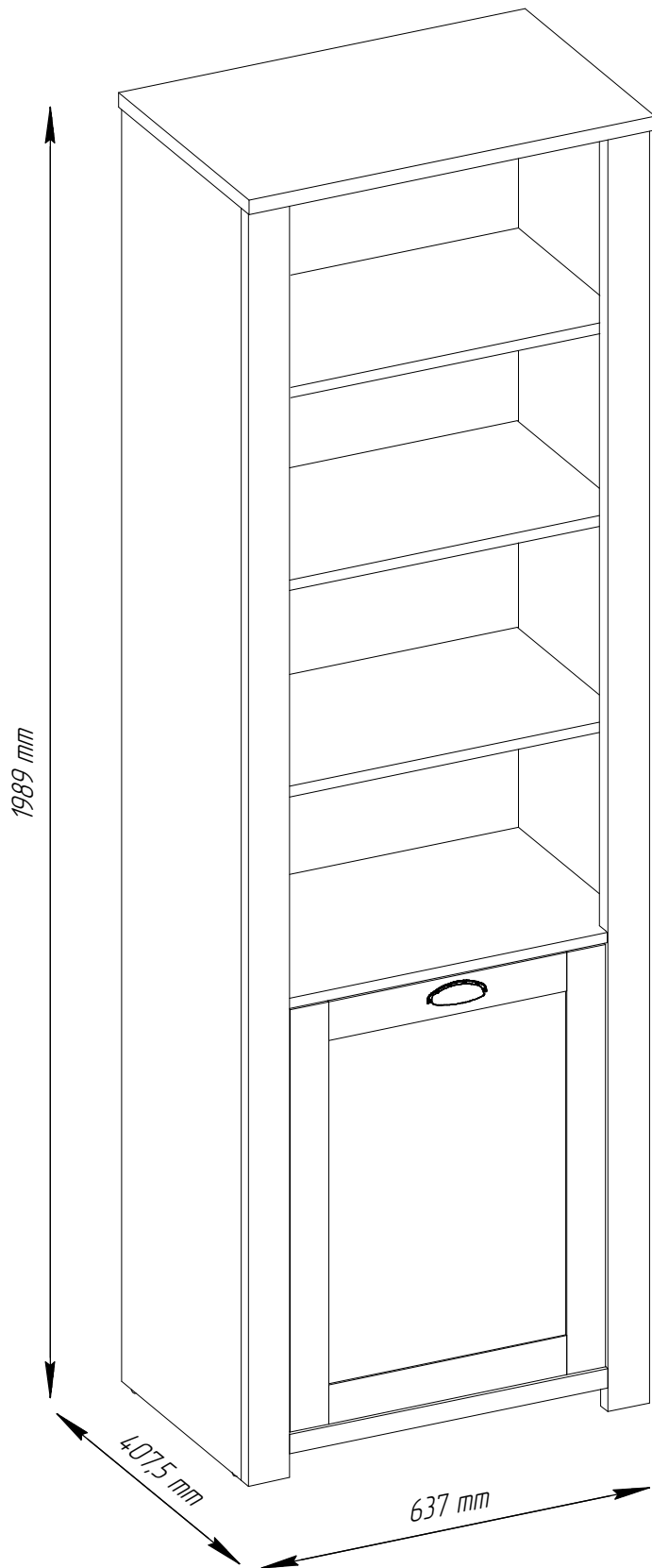

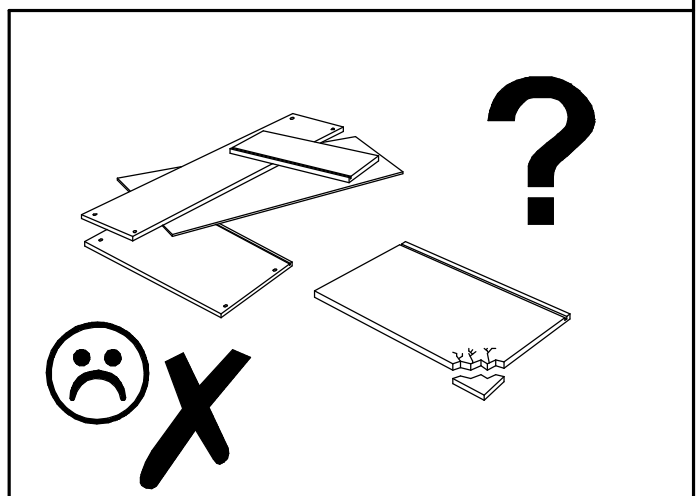

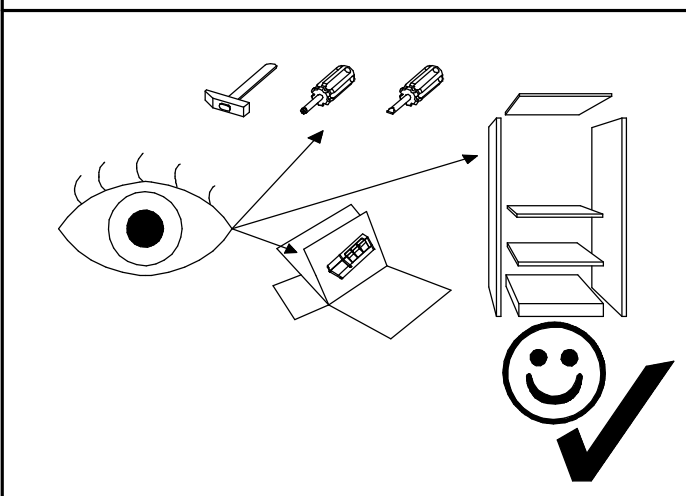
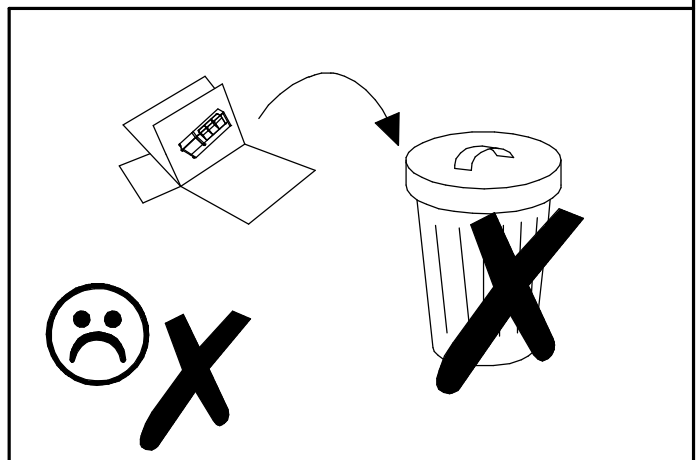
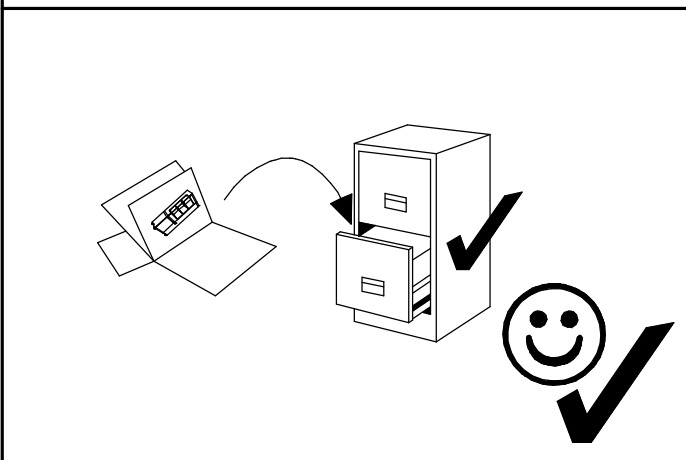
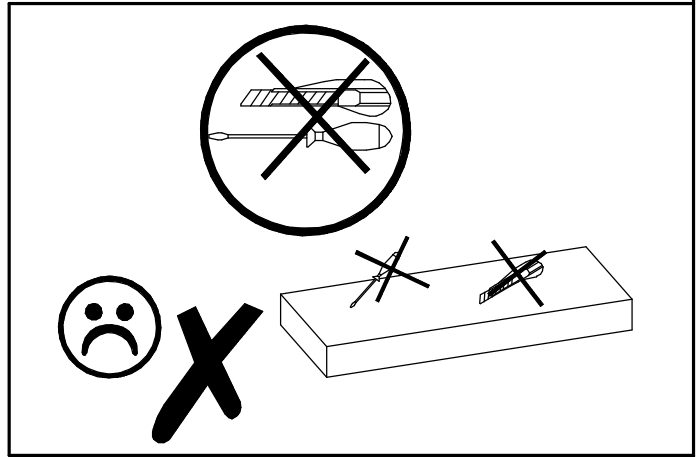
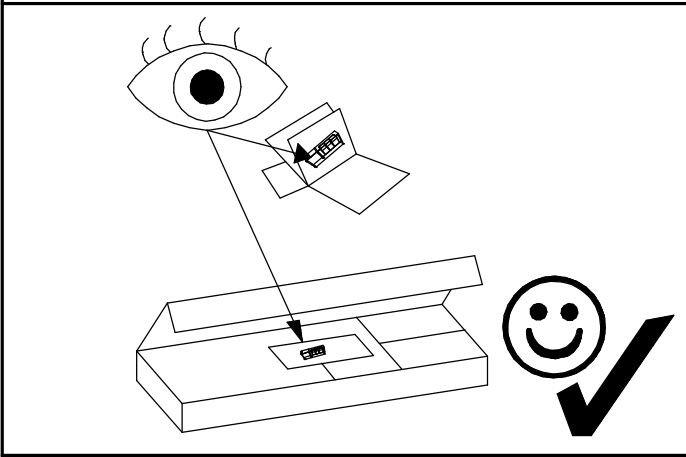
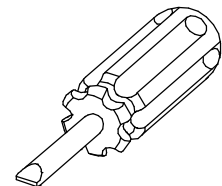
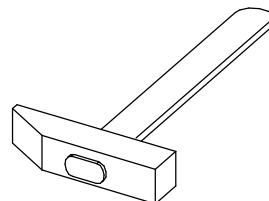
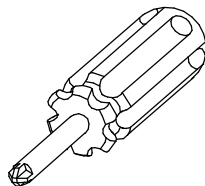
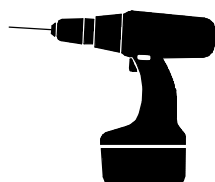
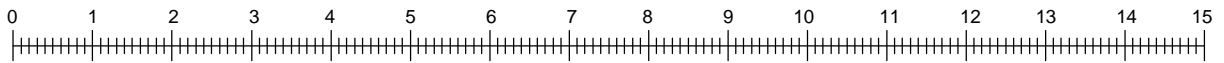
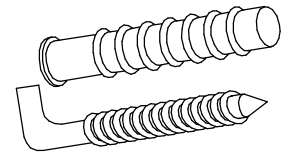
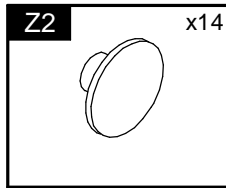
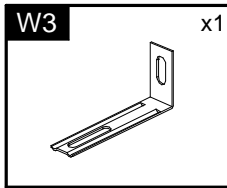
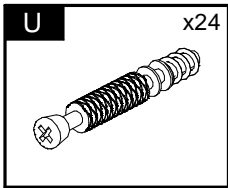
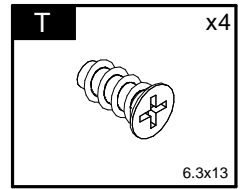
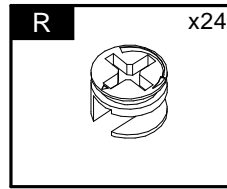
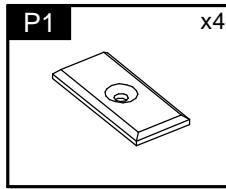
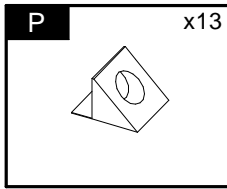
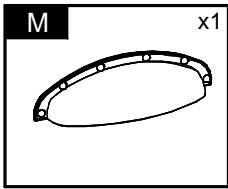
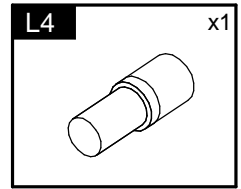
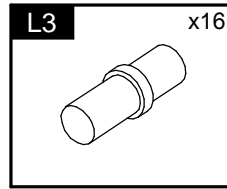
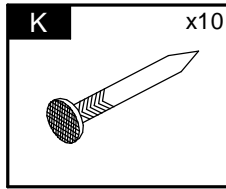
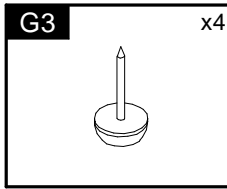
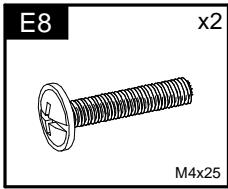
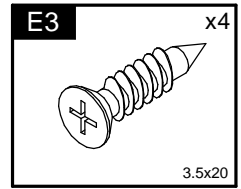
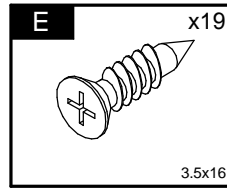
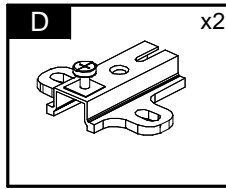
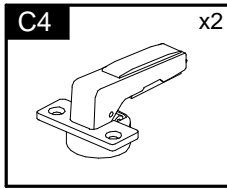
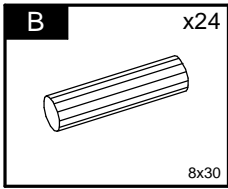
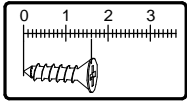
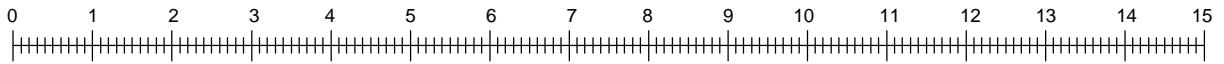

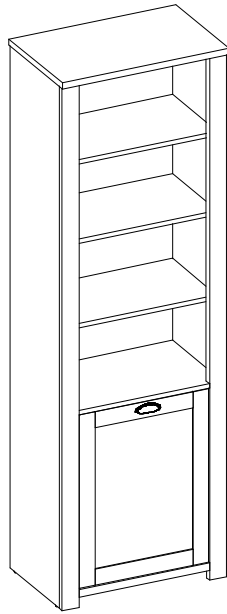

Element symbol	Measurements				Code	Paket
	1	2	3	4		
1	637	407.5	22	1	1002	1/2
2	596	376	16	1	1008	1/2
3	1962	375	16	1	1003	1/2
4	1962	375	16	1	1004	1/2
5	596	355	16	1	1005	1/2
6	596	50	16	1	1007	1/2
7	596	345	16	4	N/A	1/2
8	1240	610	3	1	N/A	1/2
9	678	610	3	1	N/A	1/2
10	1962	65	22	1	3001	1/2
11	1962	65	22	1	3002	1/2
12	499	30	22	1	3003	1/2
13	649	494	19	1	3007	2/2

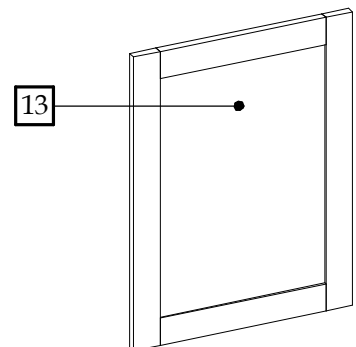
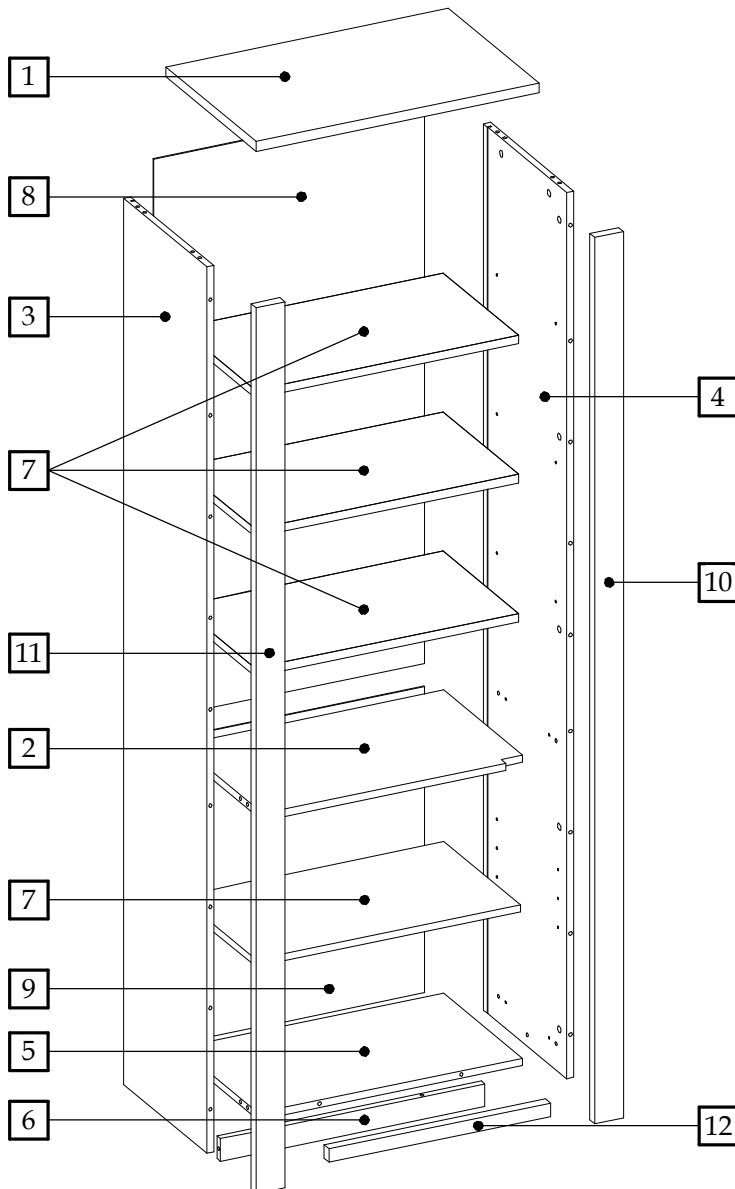

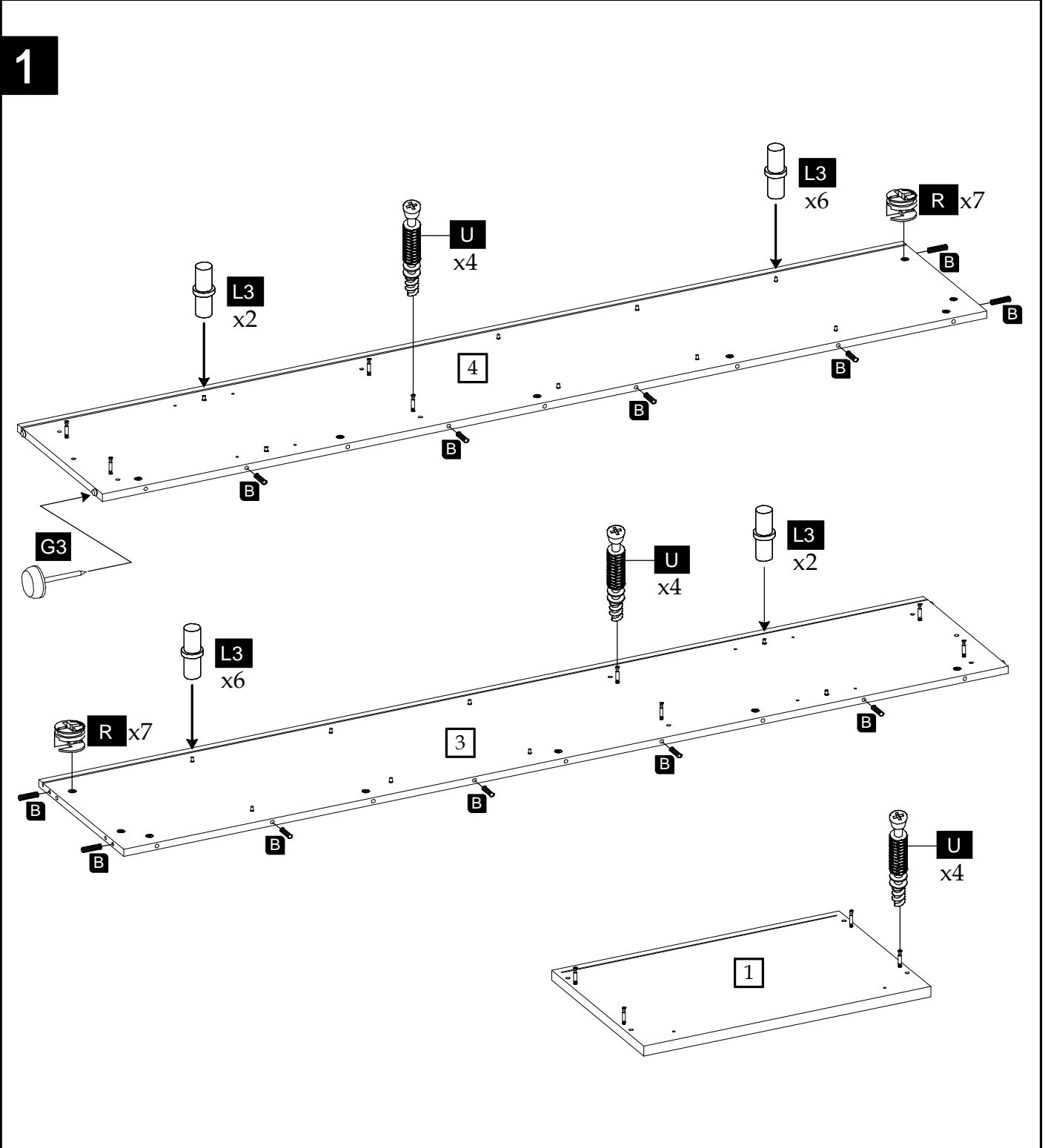
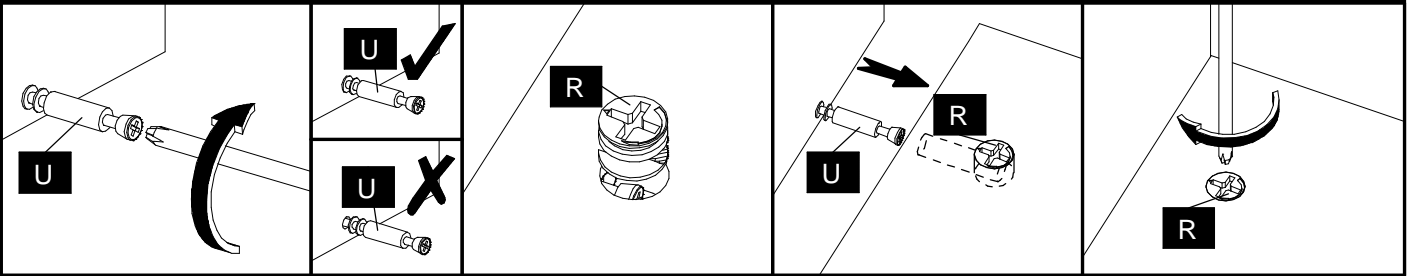

2

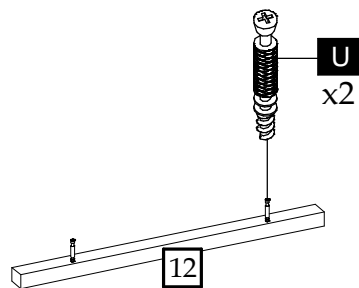
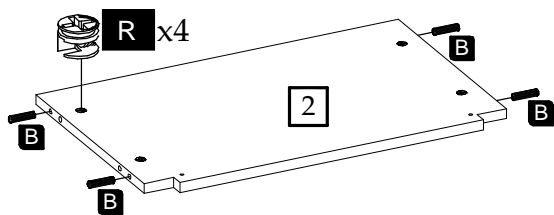

3

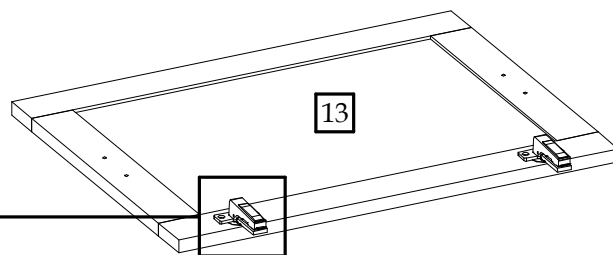
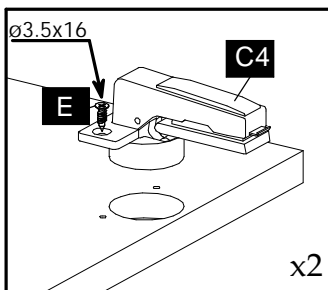

4

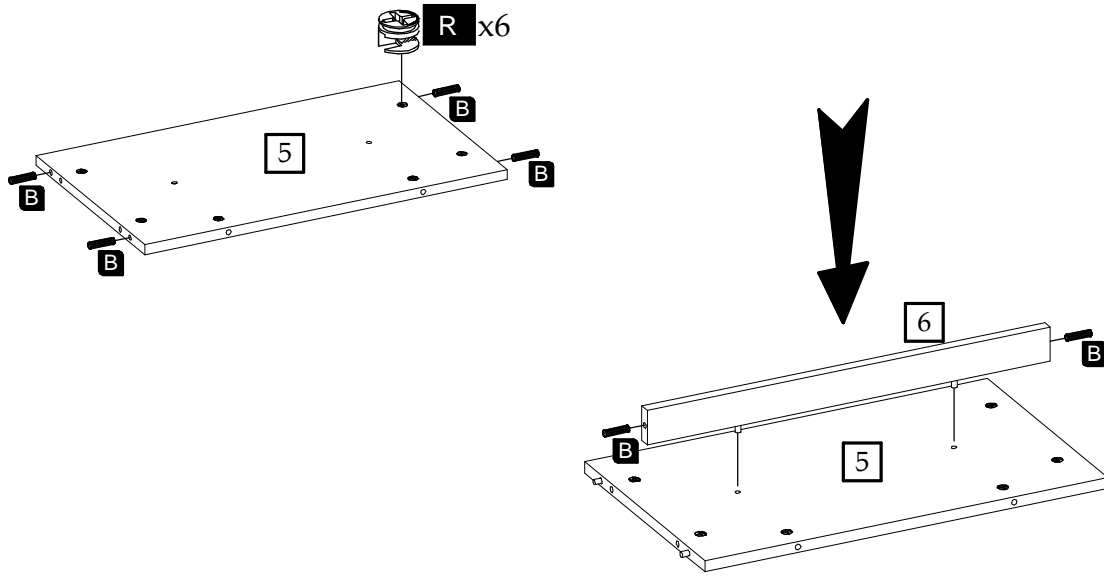

5

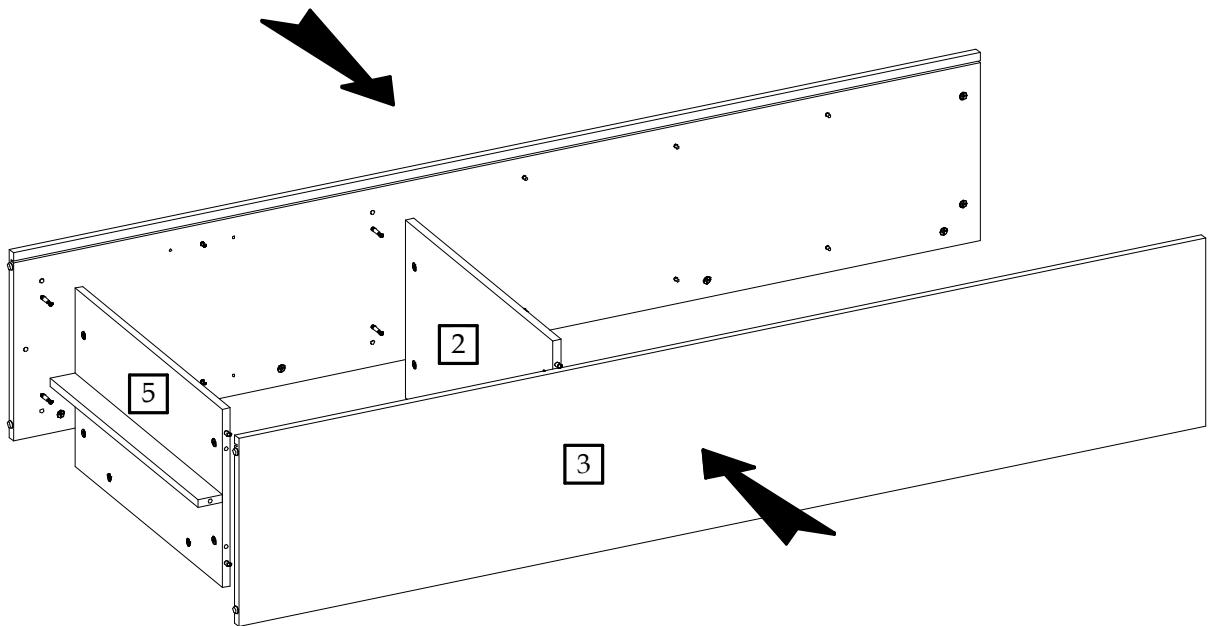
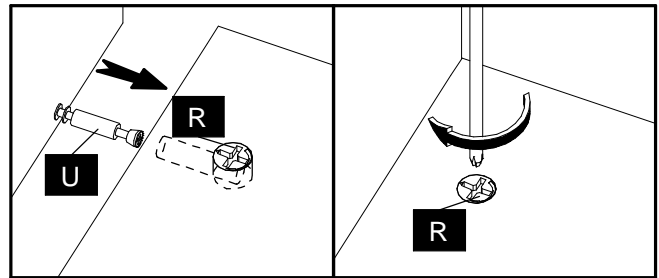

6

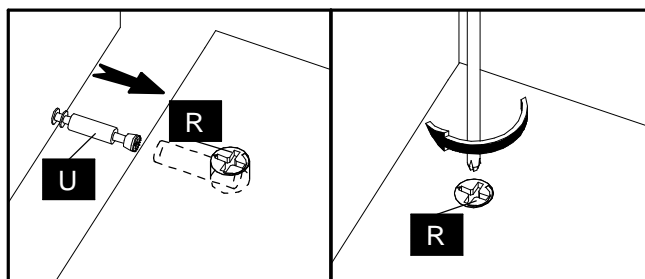
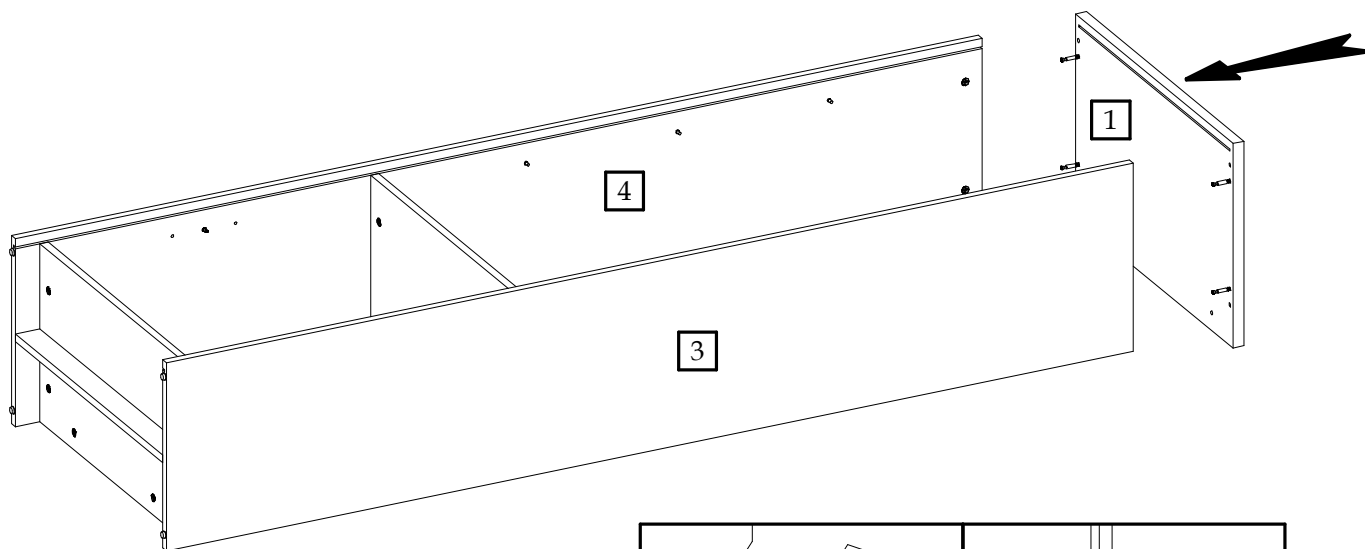

7

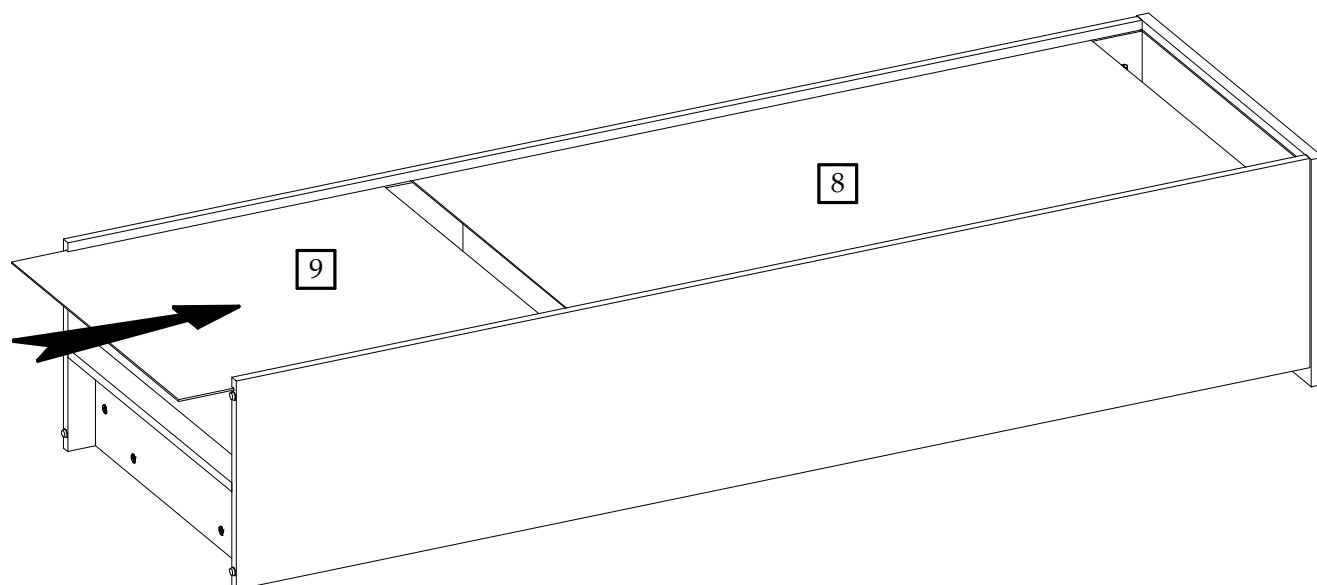

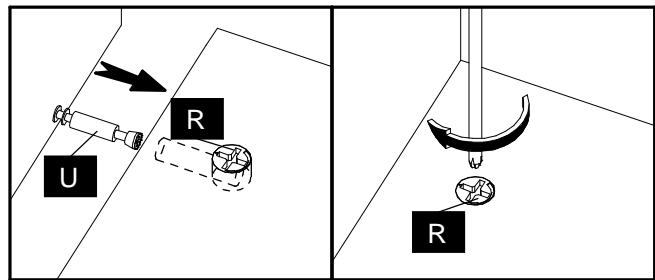
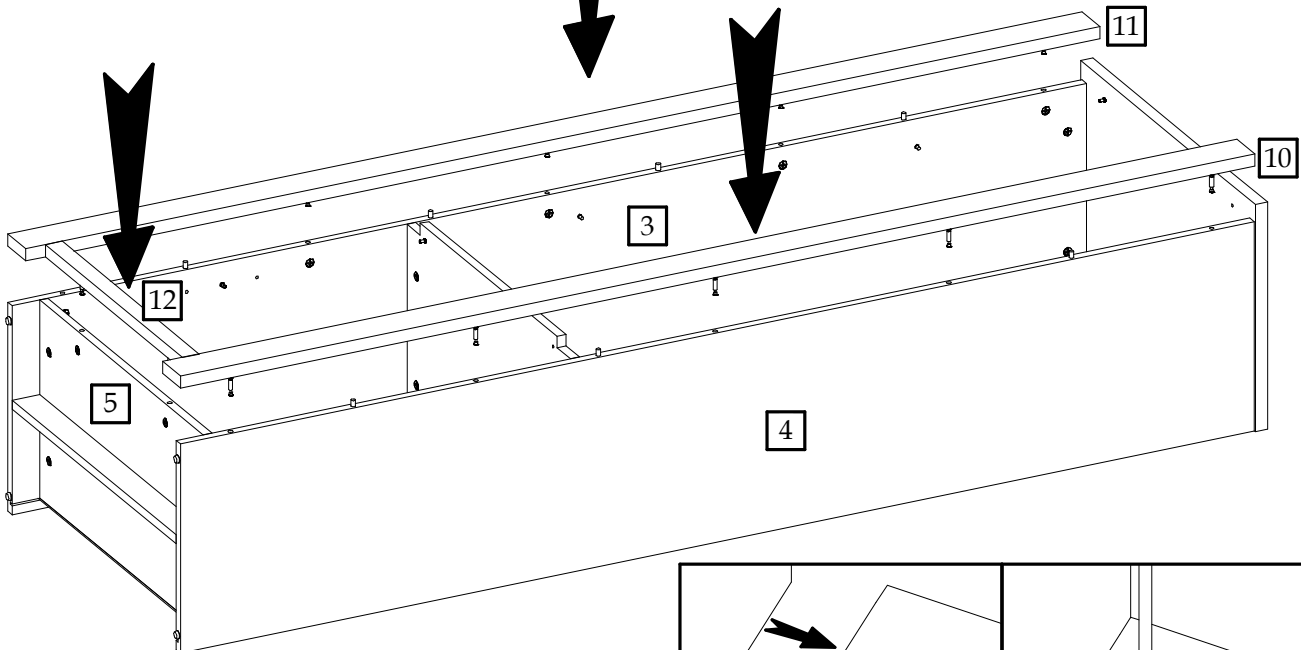
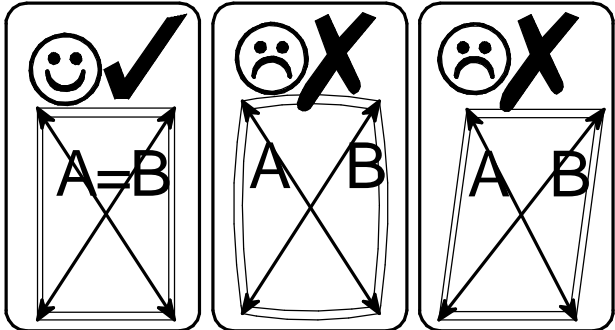
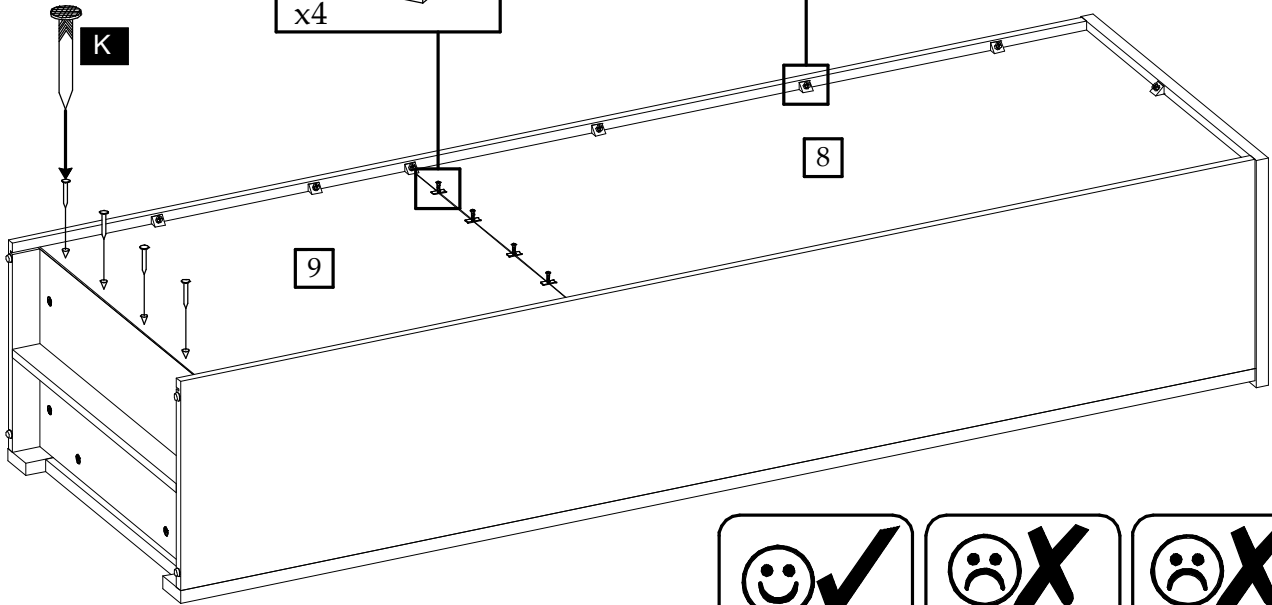
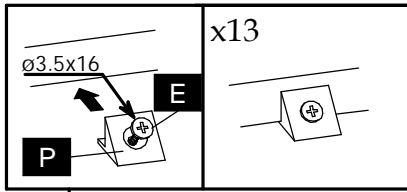
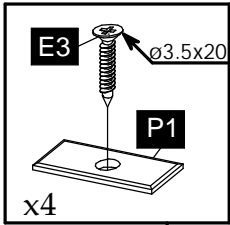

Right

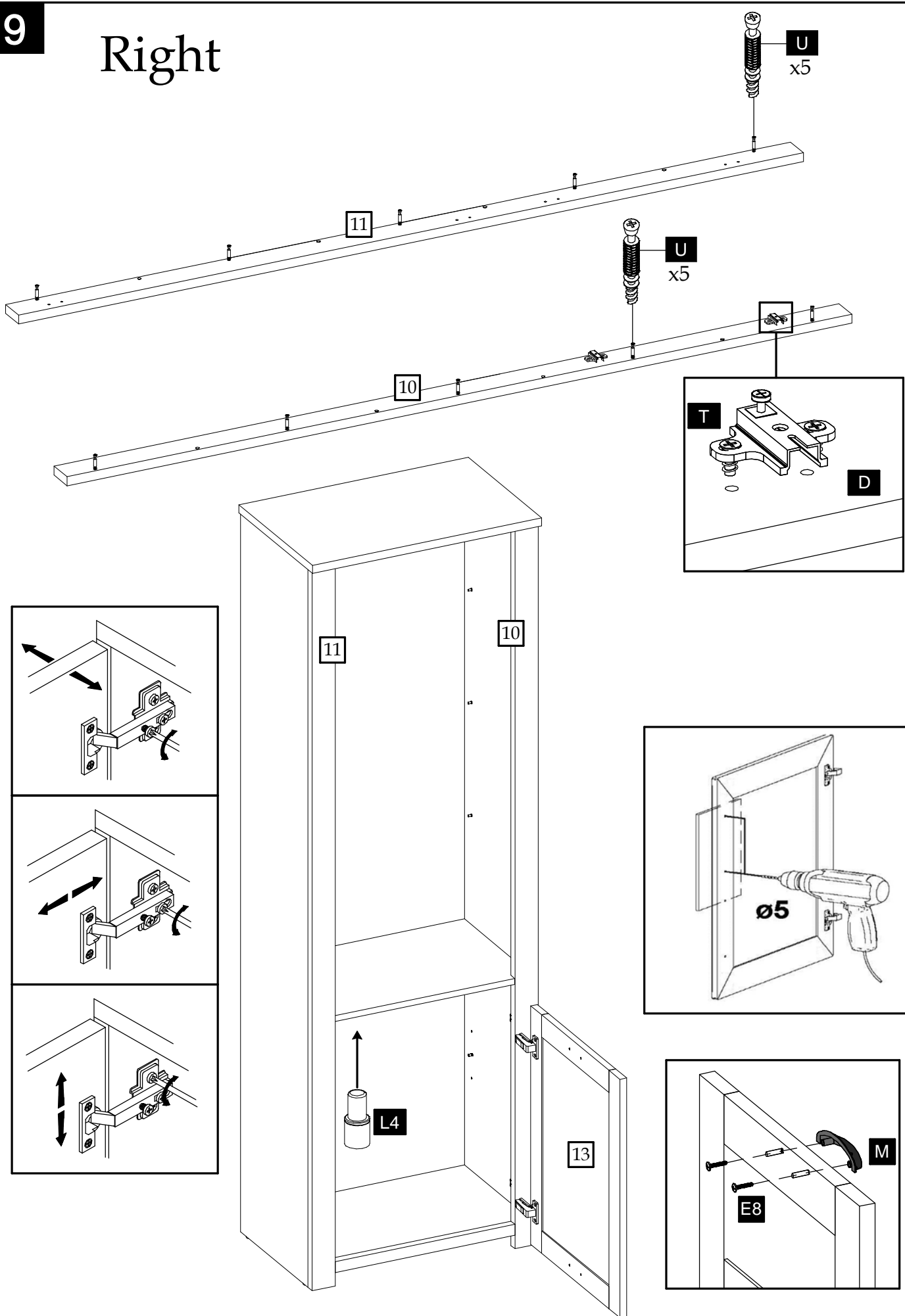

10

Left

