

PAWEL

Typ A1

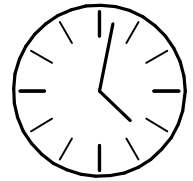

60 min

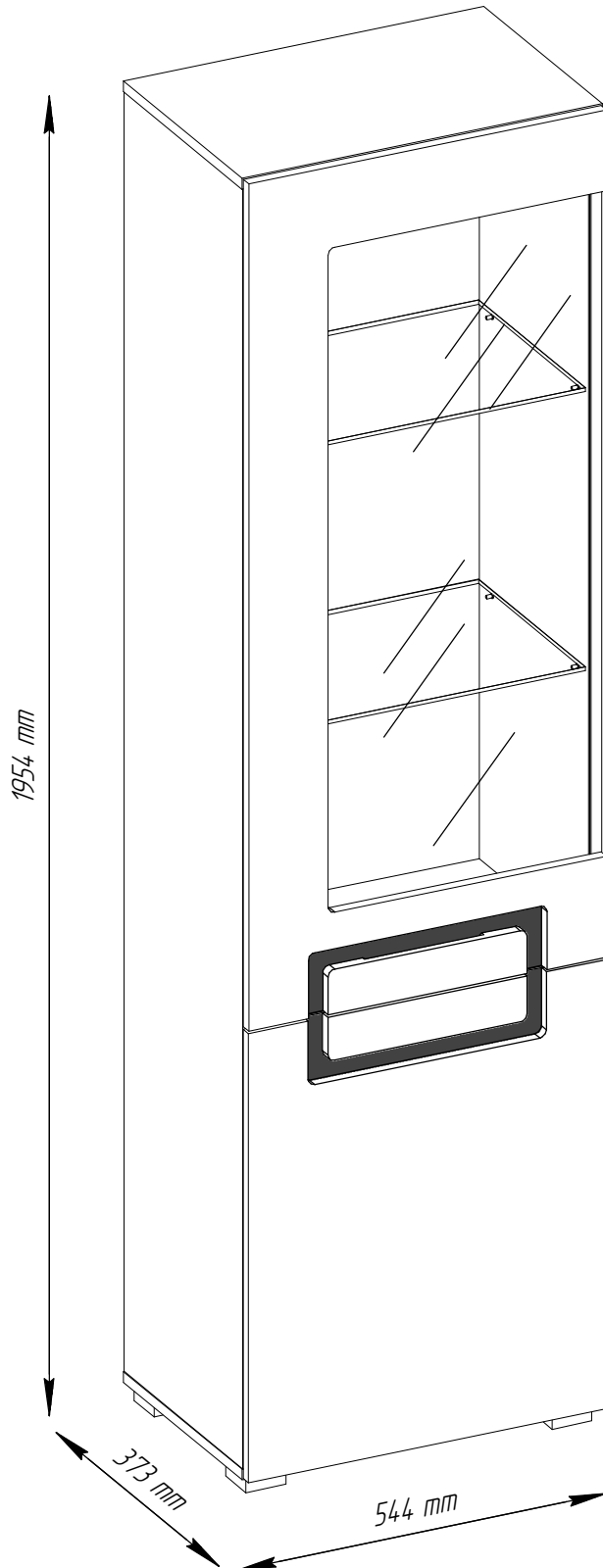
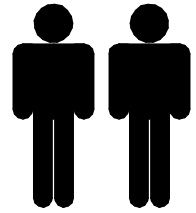

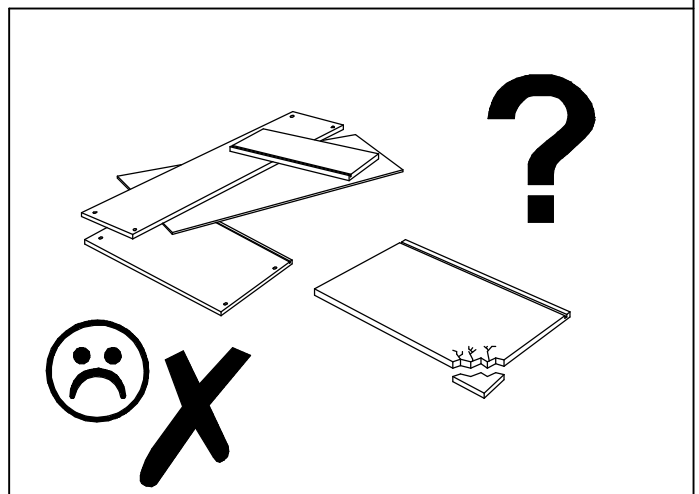
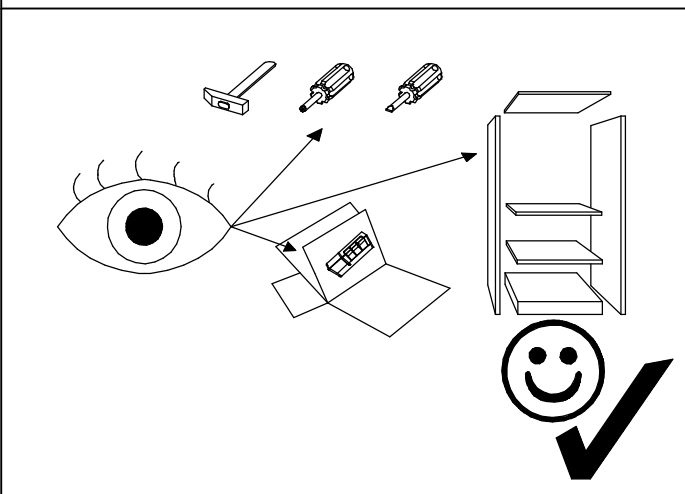
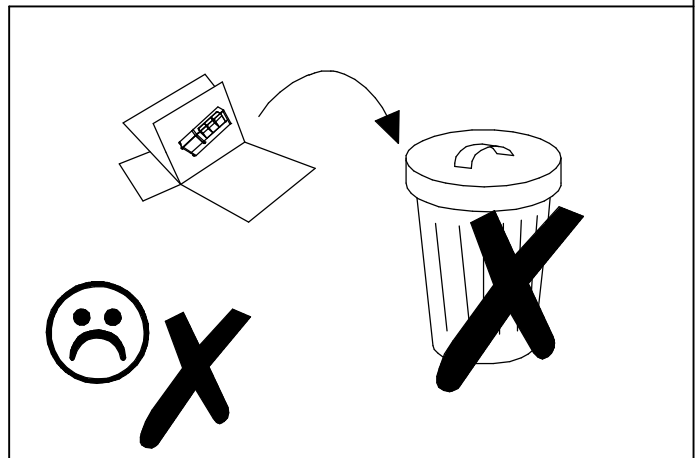
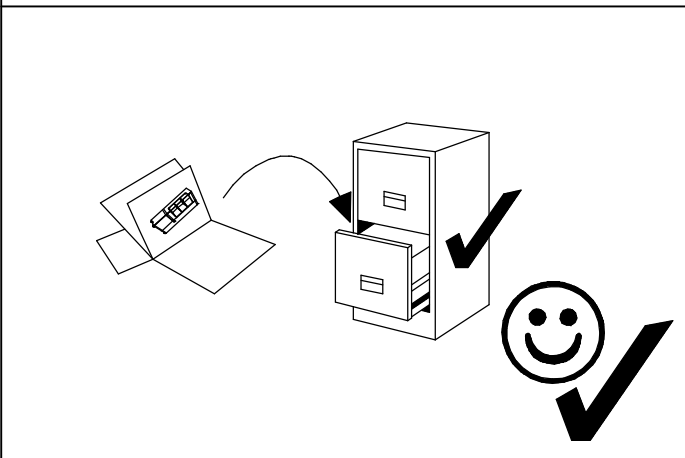
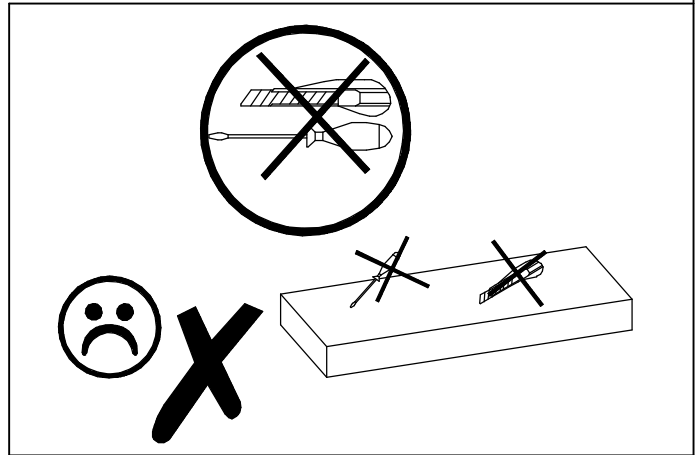
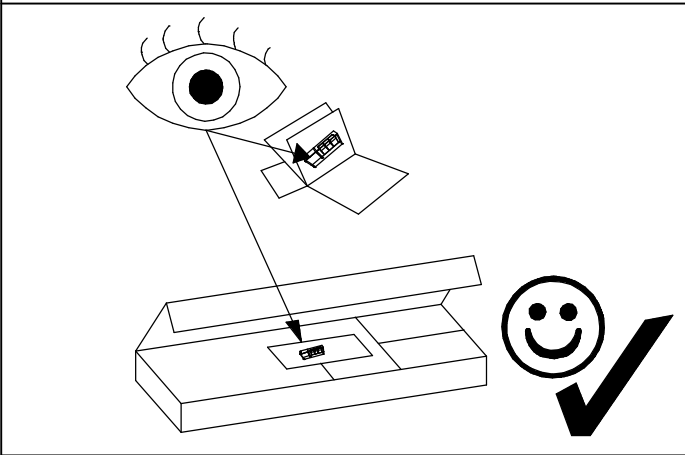

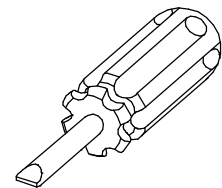
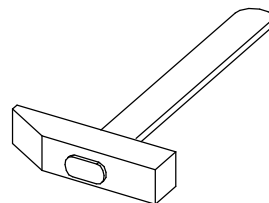
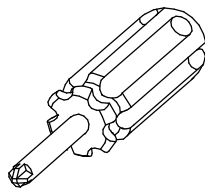
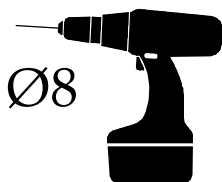
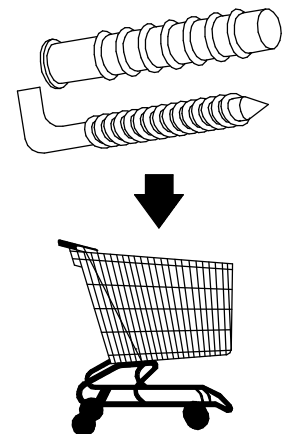
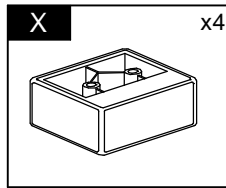
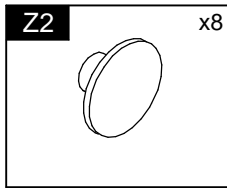
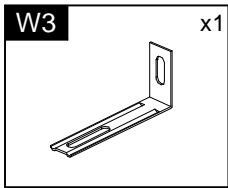
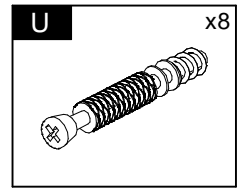
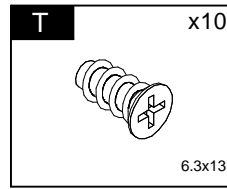
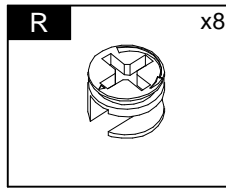
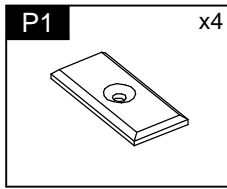
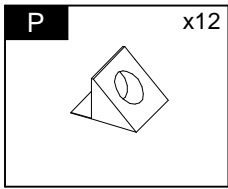
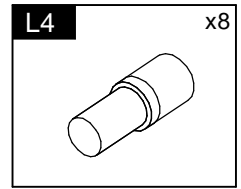
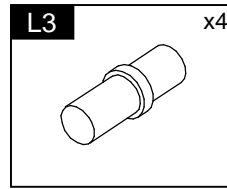
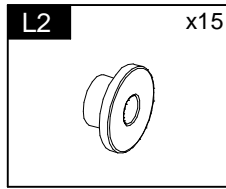
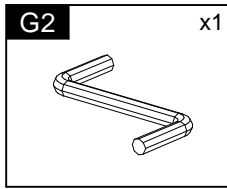
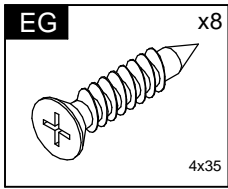
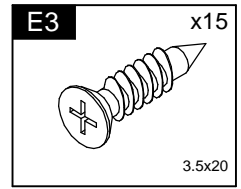
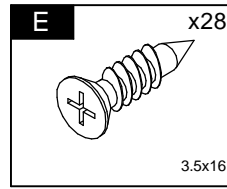
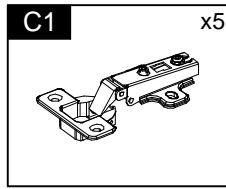
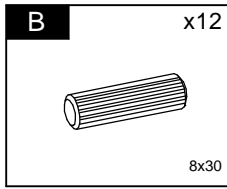
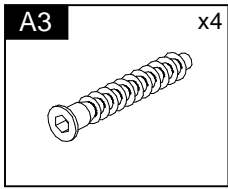
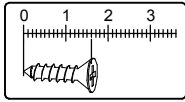
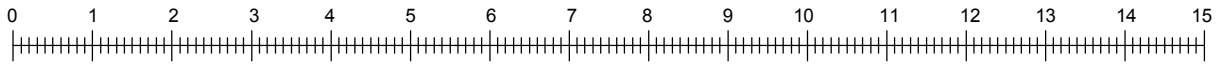

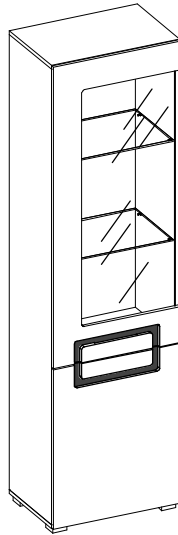

Element symbol	Measurements				Code	Paket
1	1897	356.5	16	1	1004	1/3
2	1897	356.5	16	1	1005	1/3
3	544	357	16	1	1027	1/3
4	544	357	16	1	1028	1/3
5	510	331	16	1	1022	1/3
6	510	325	16	1	N/A	1/3
7	1250	524	3	1	N/A	1/3
8	660	524	3	1	N/A	1/3
9	668	542	16	1	1025/3009	2/3
10	1258	542	16	1	1024/3019	2/3
11	301	67	16	2	1022/3033	2/3
12	420	100	4	2	Glass	3/3
13	1050	435	4	1	Glass	3/3
14	509	320	6	2	Glass	3/3

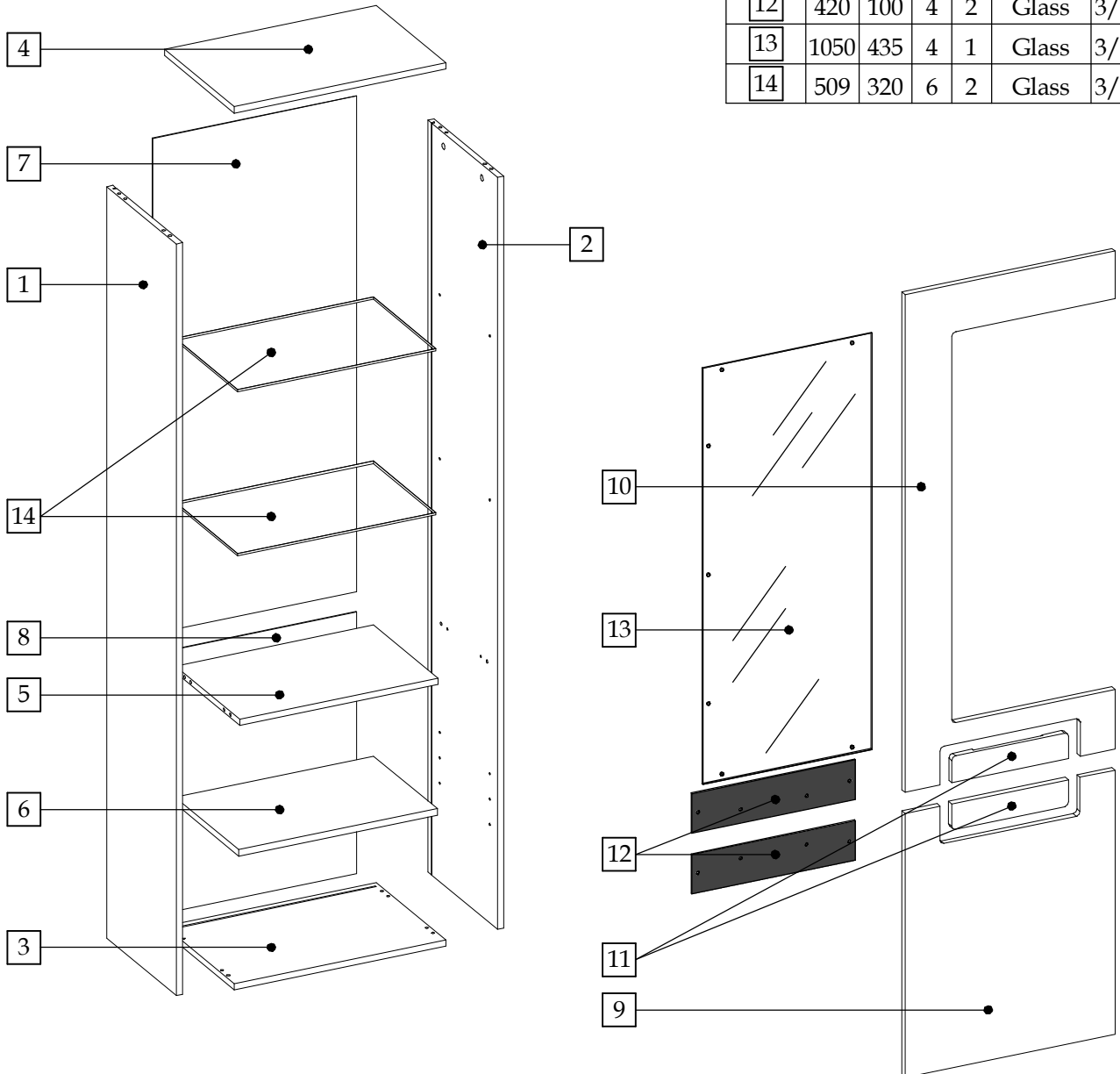

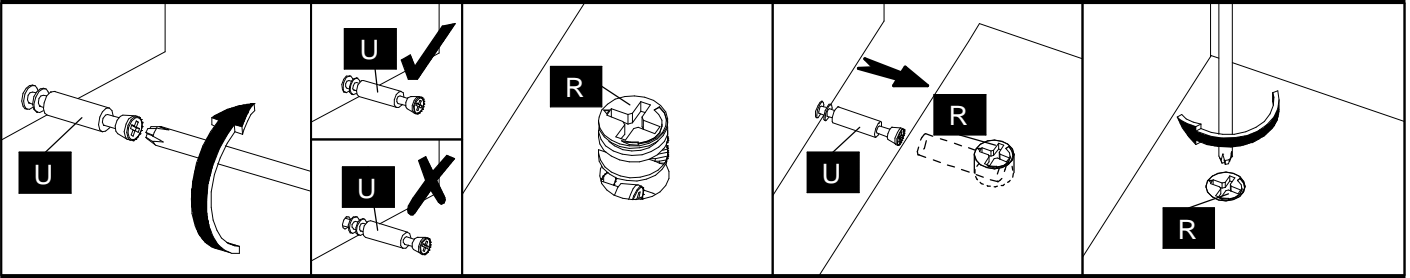

1

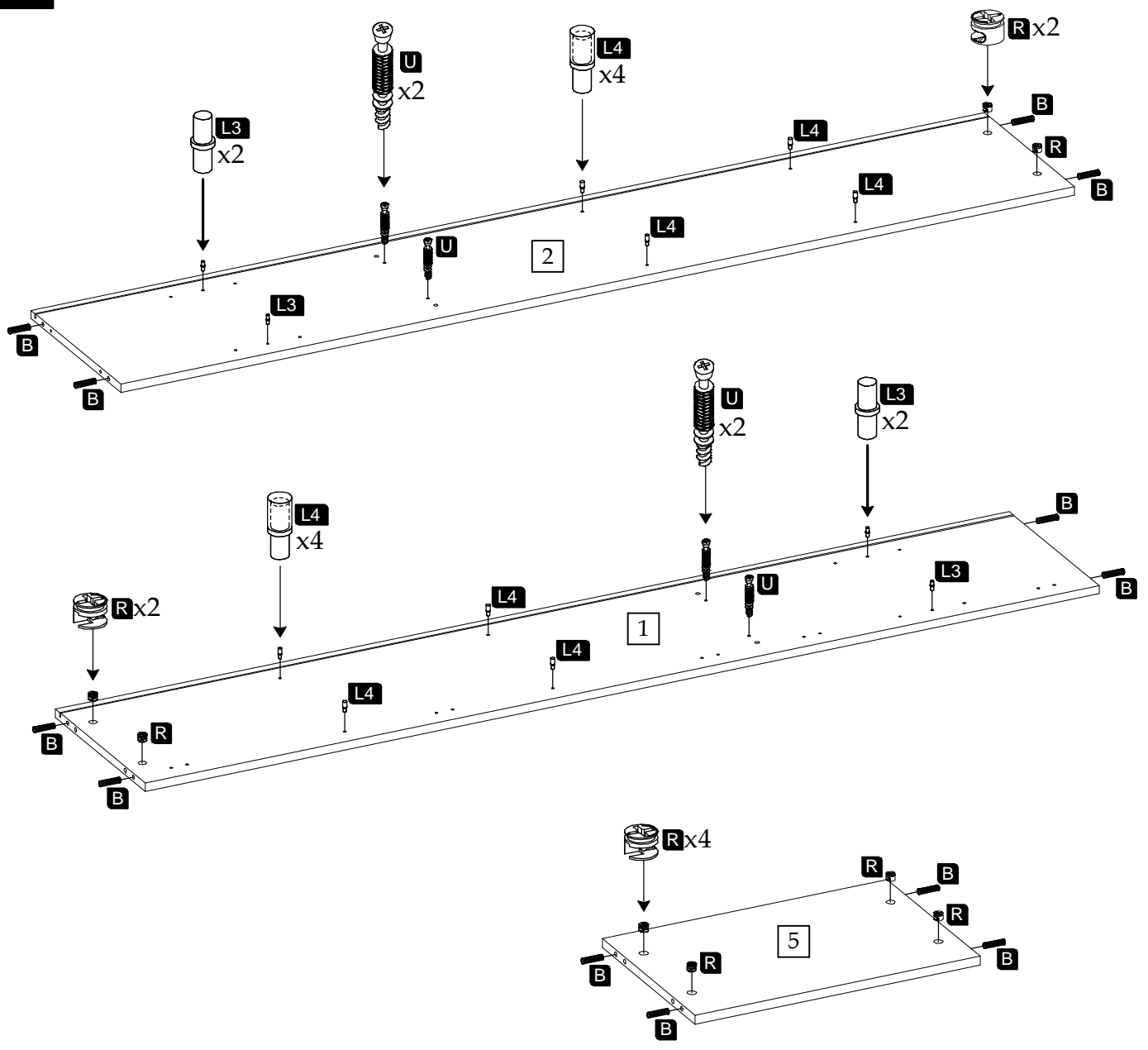

2

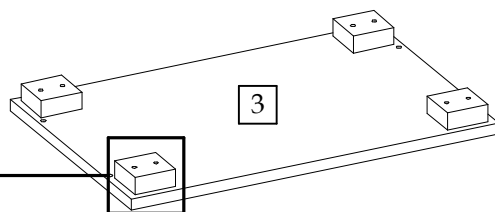
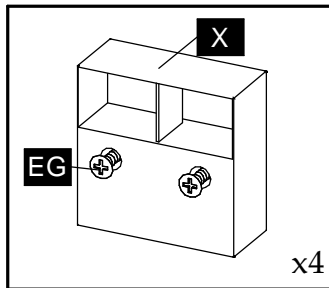
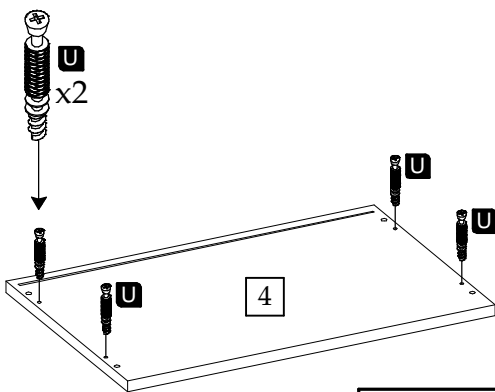

3

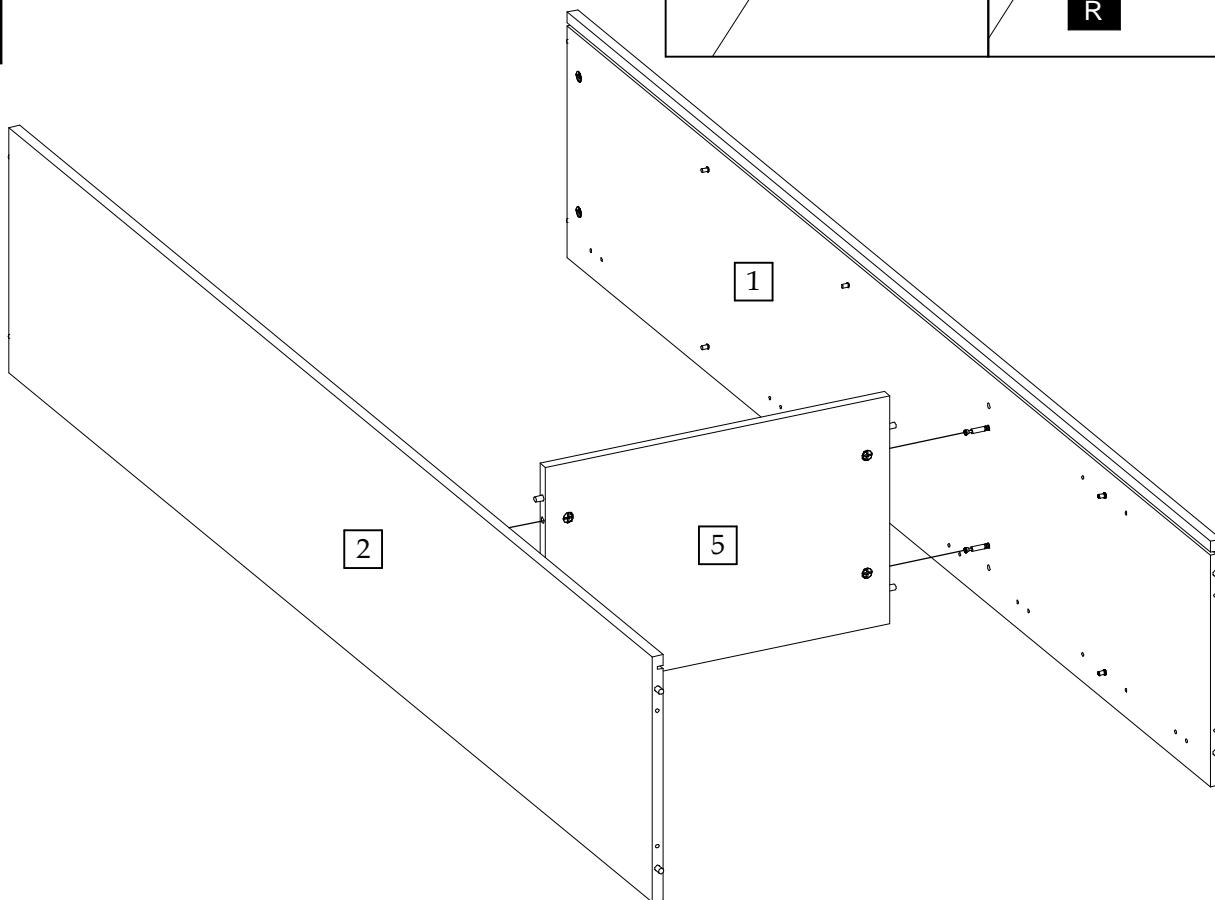
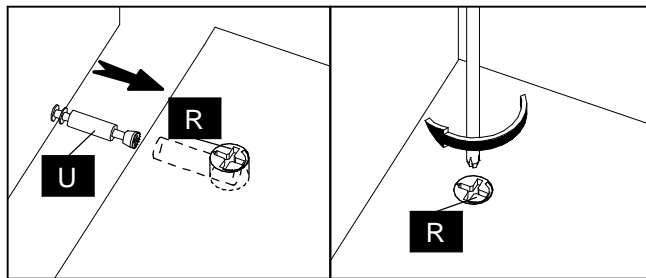

4

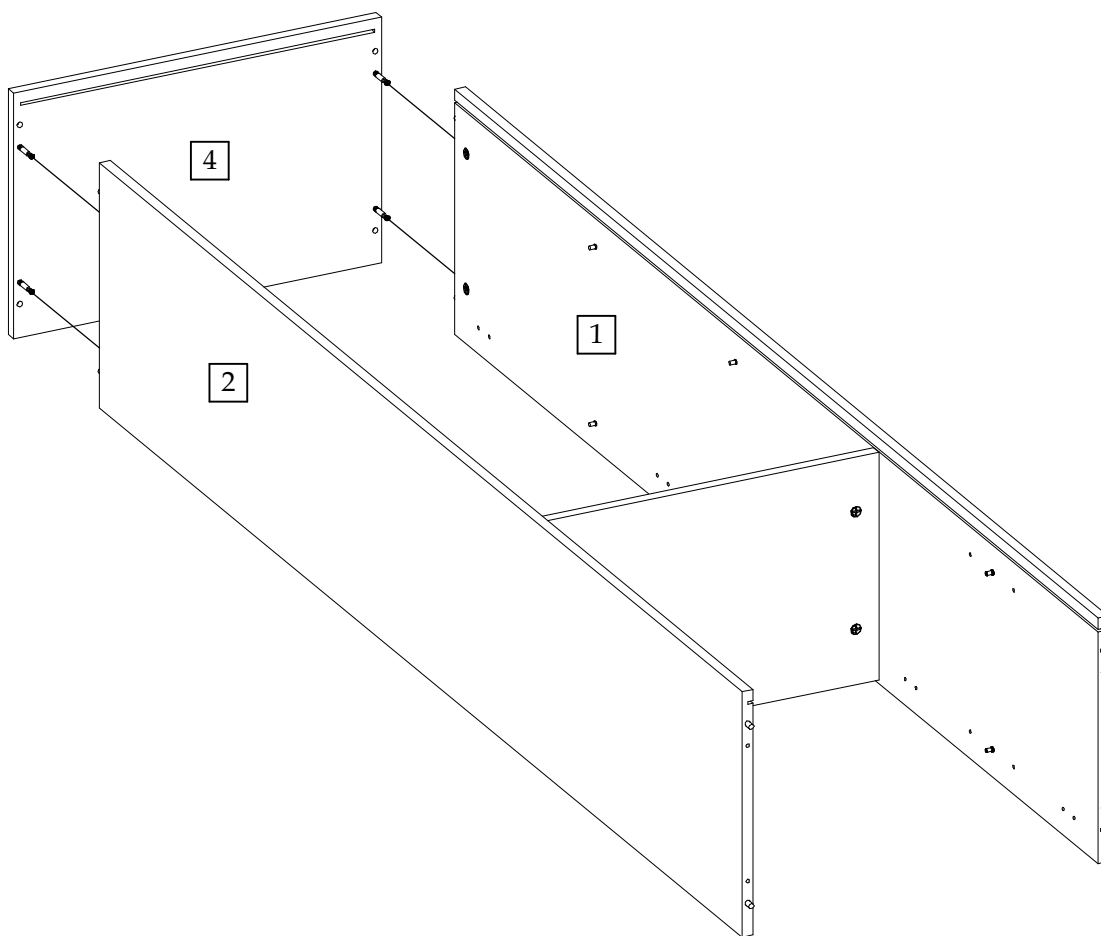

5

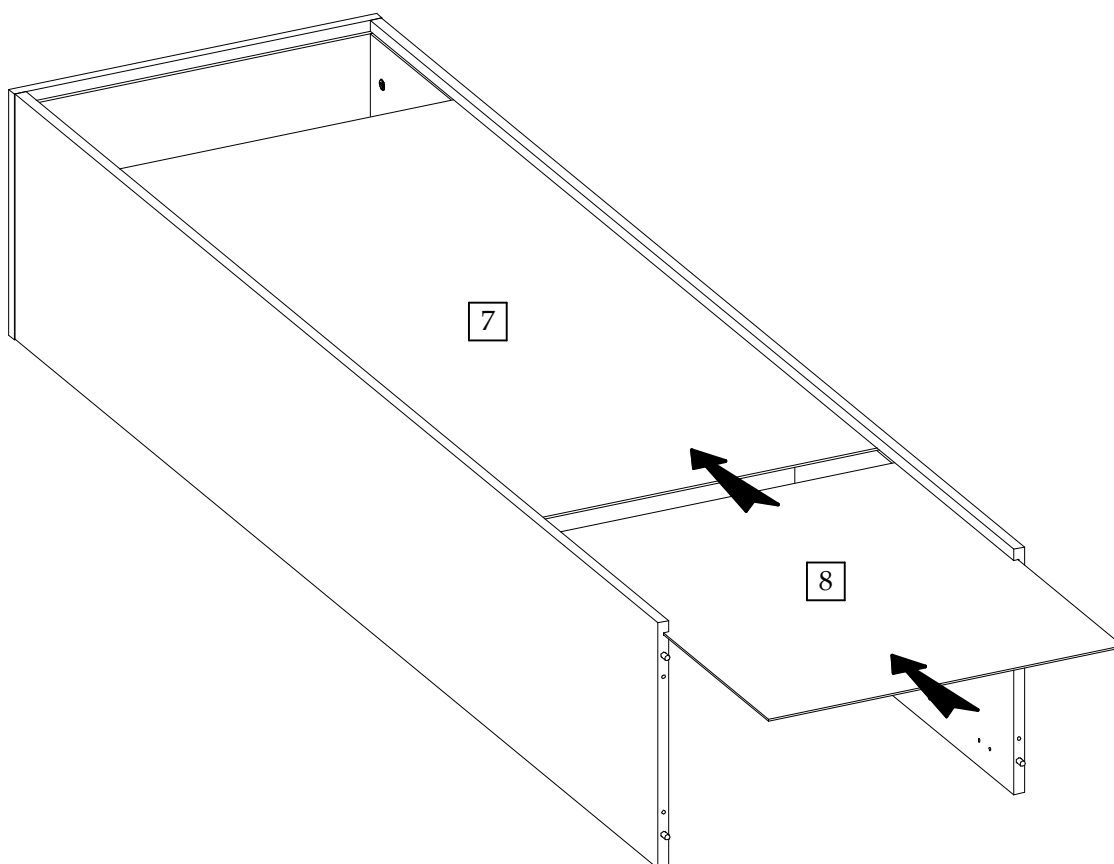

6

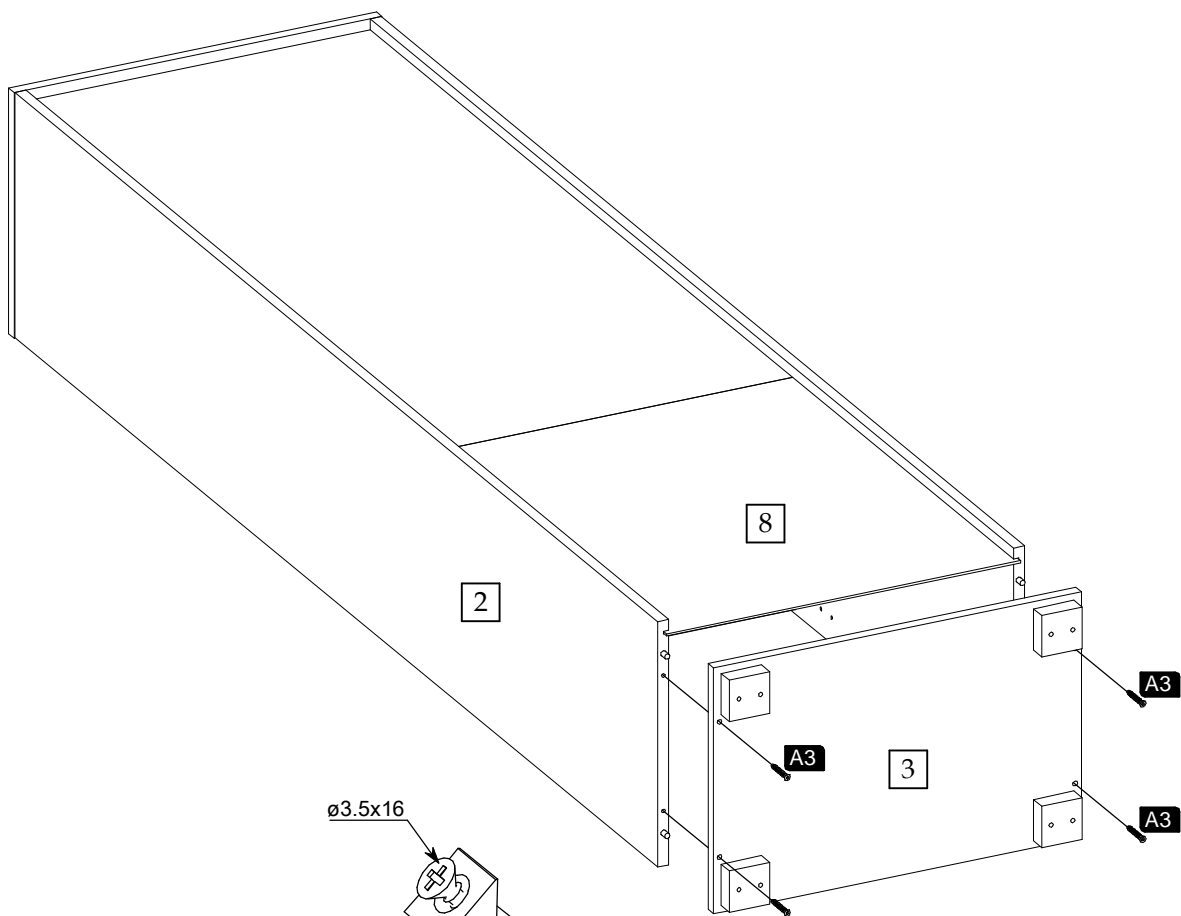

7

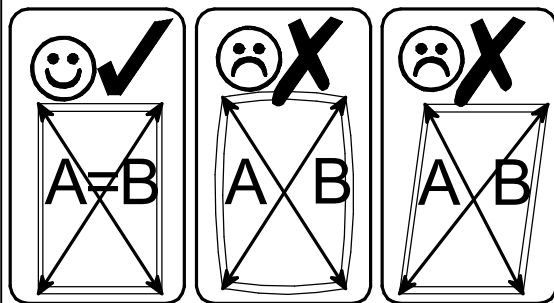
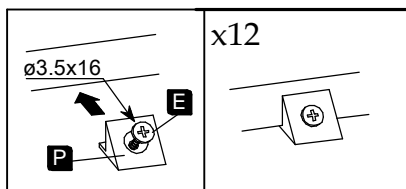
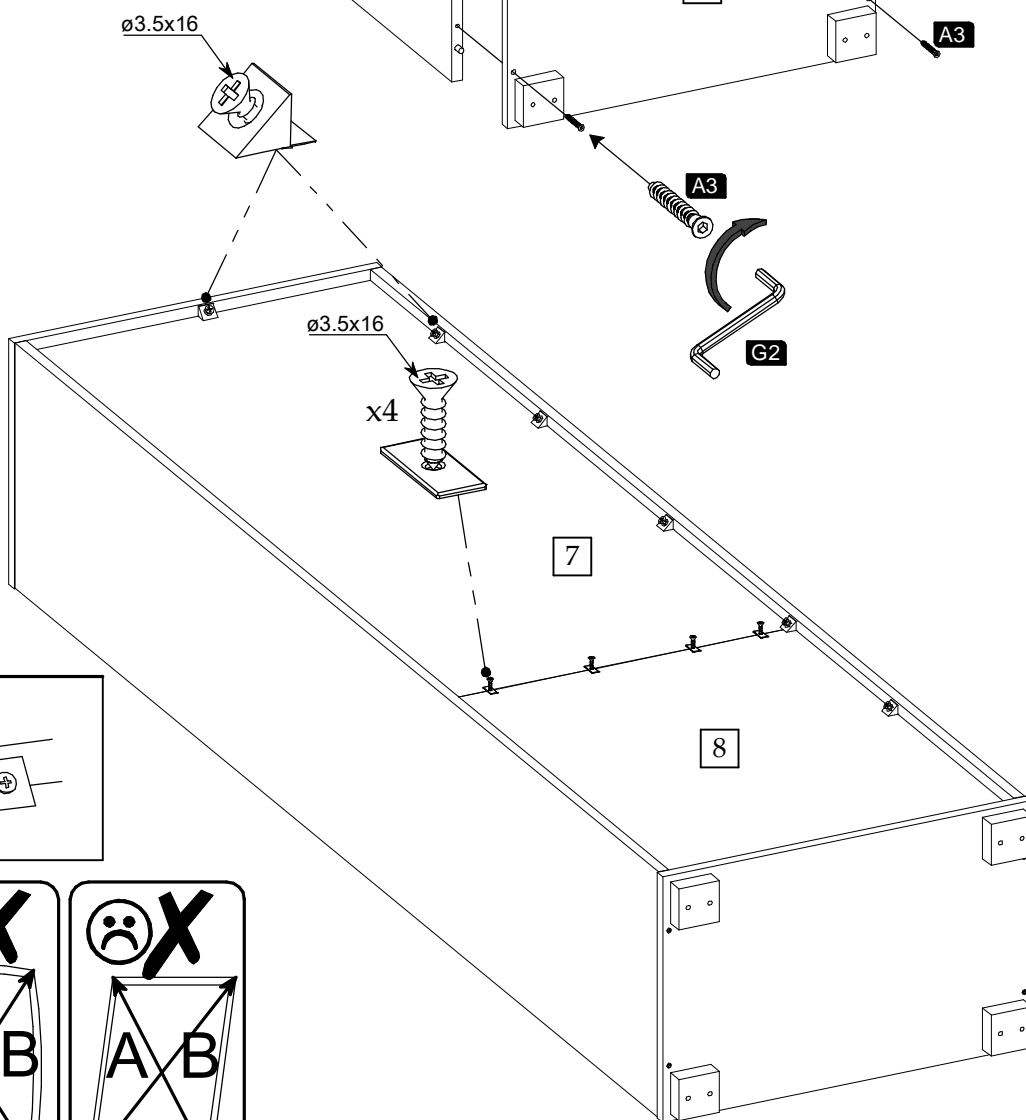

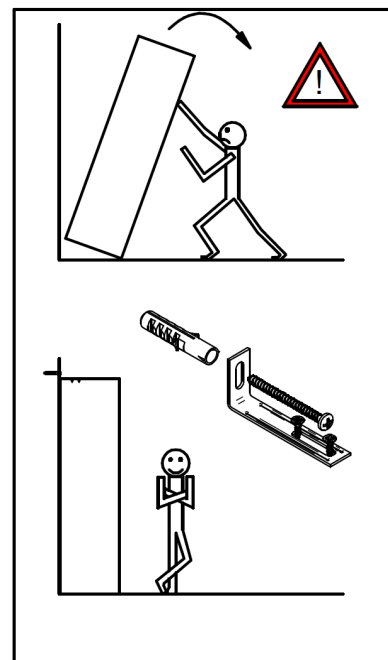
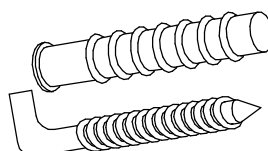
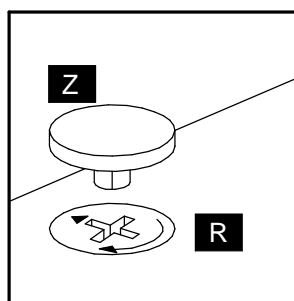
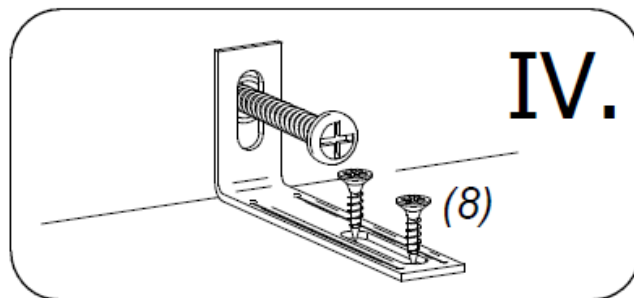
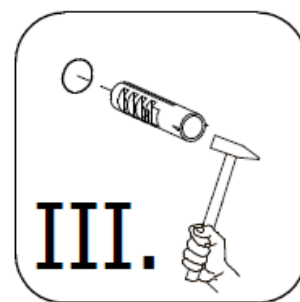
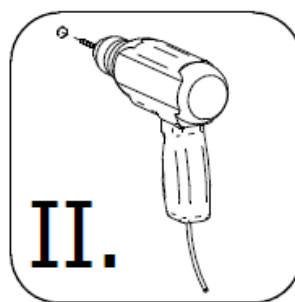
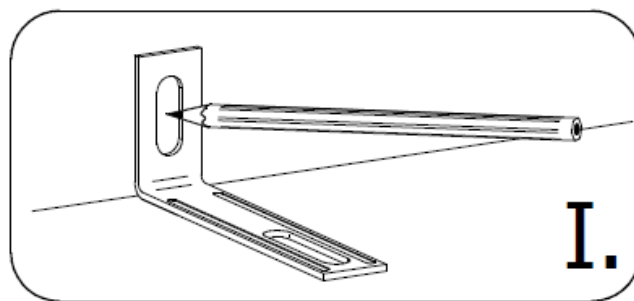
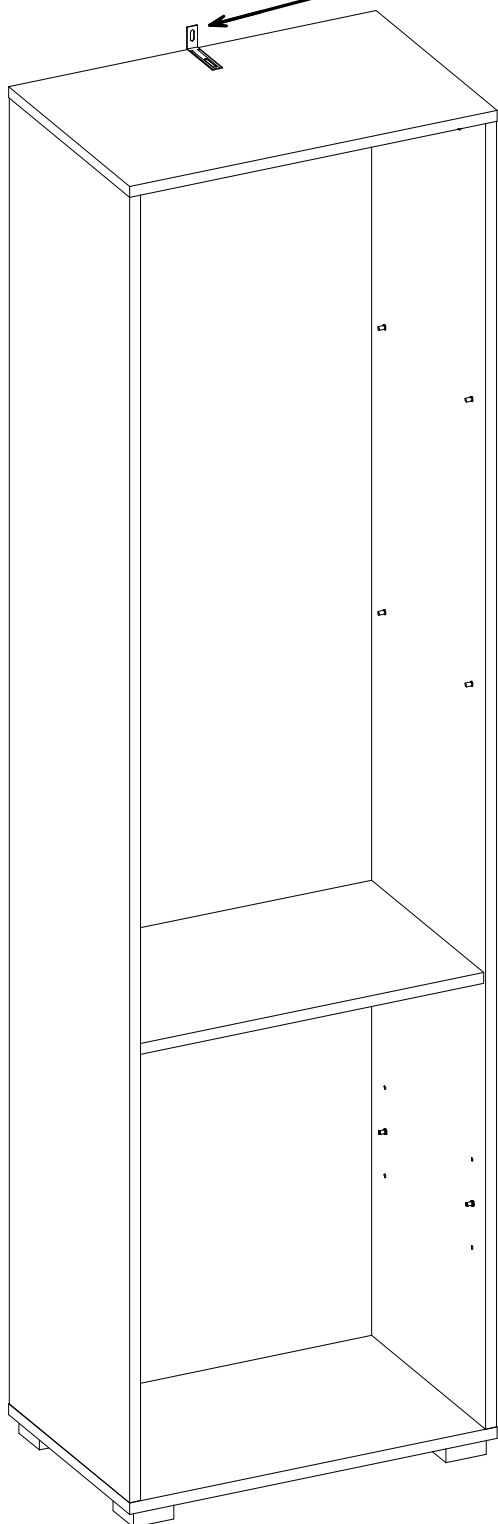

9

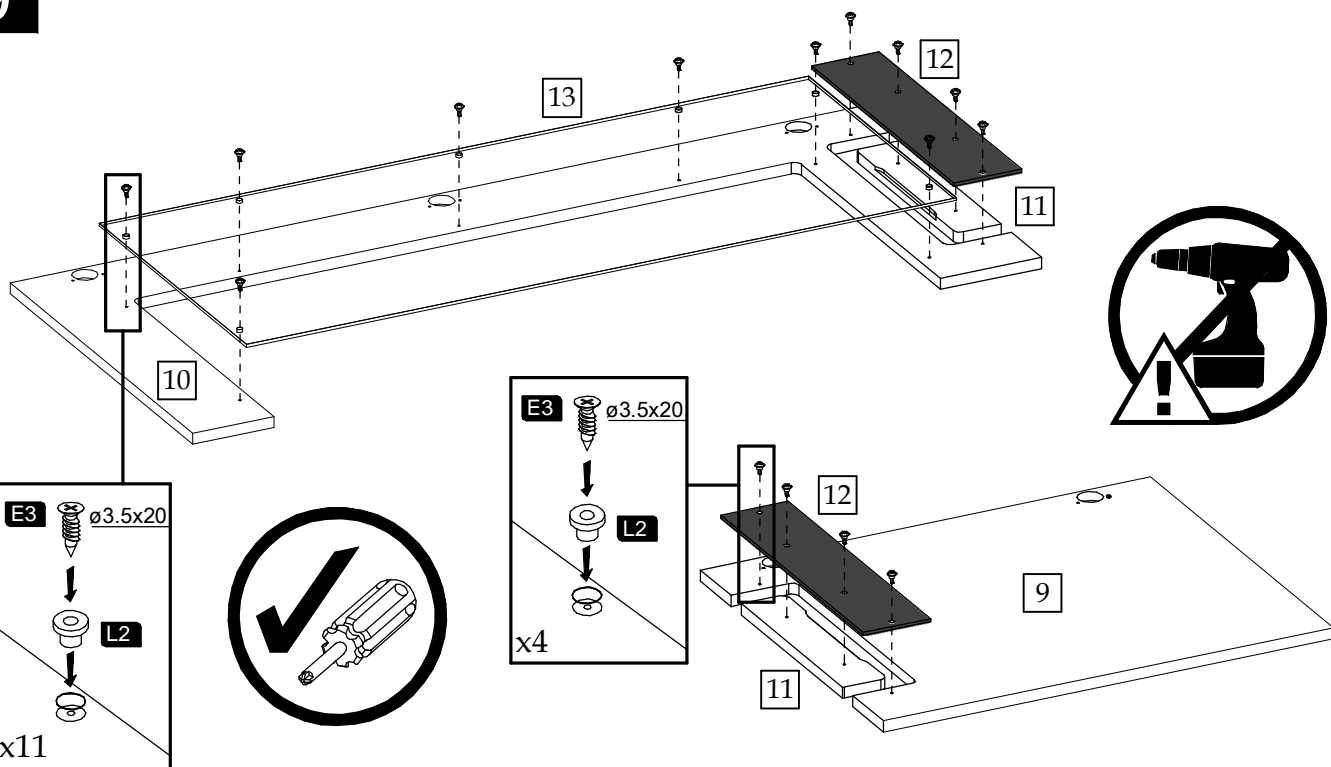

10

