

PAWEL

Typ E

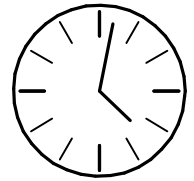

75 min

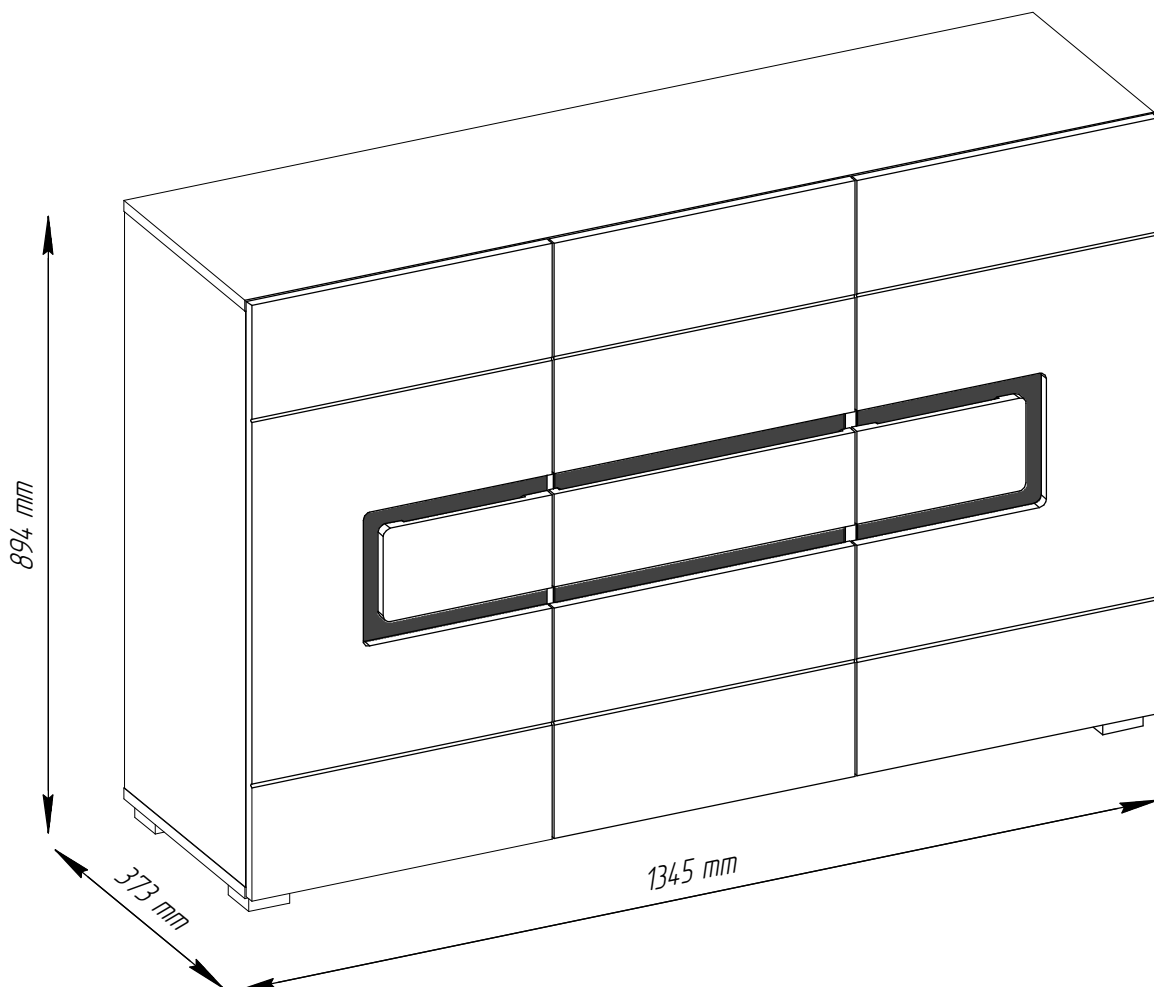
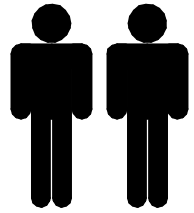

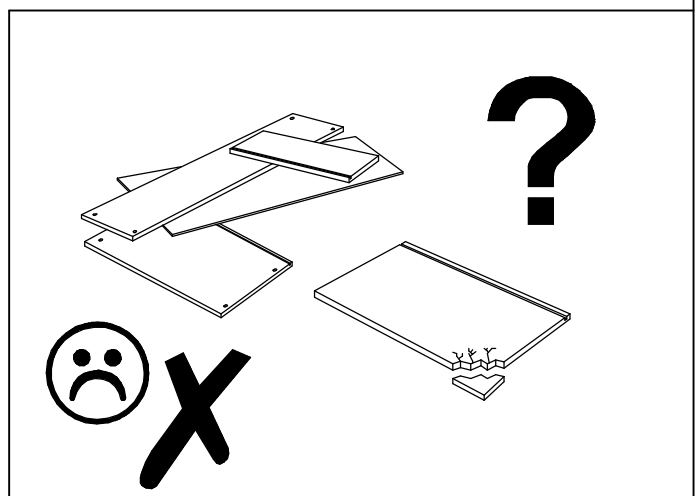
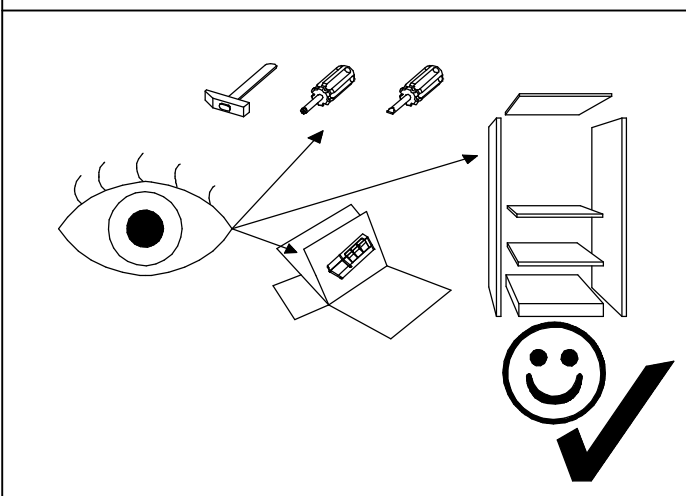
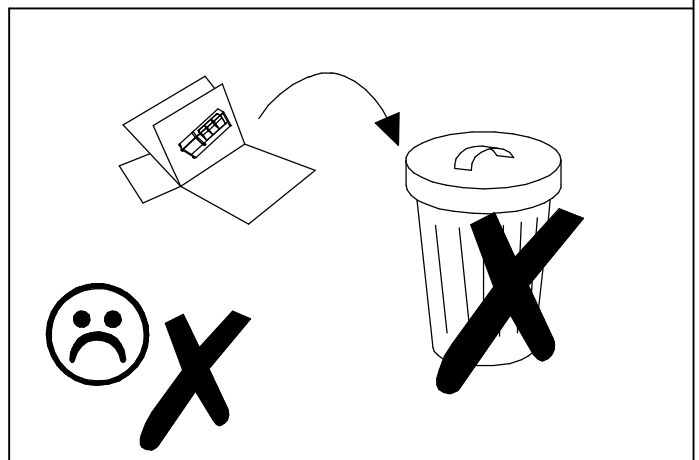
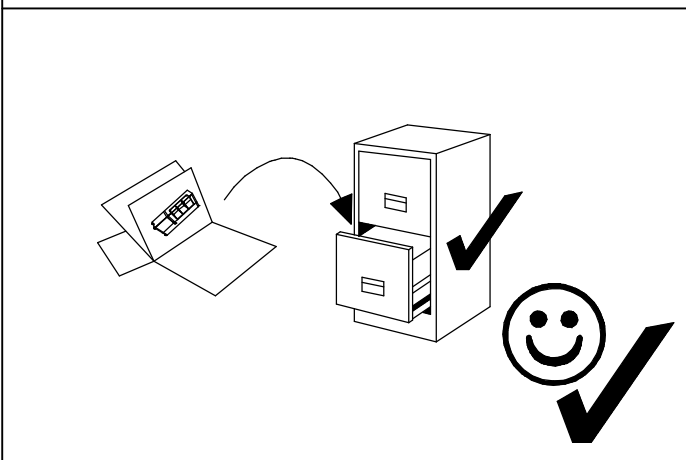
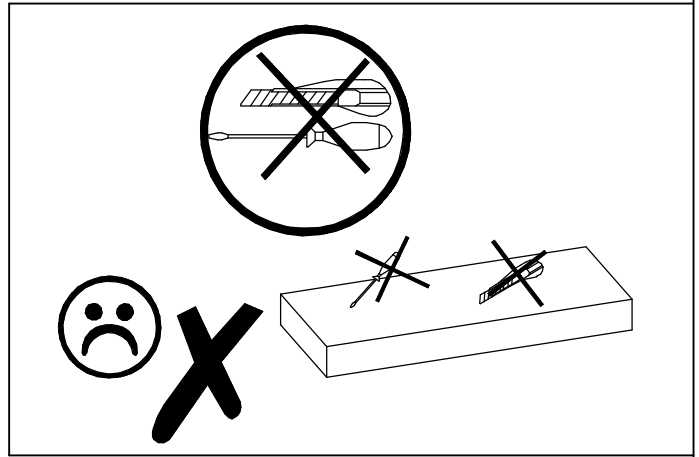
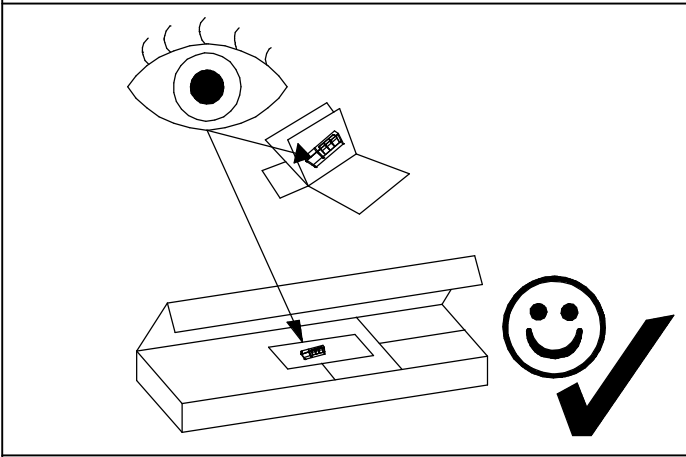

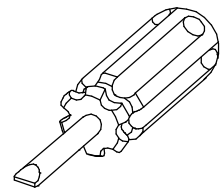
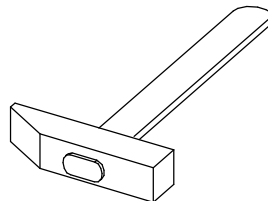
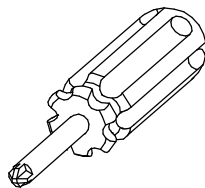
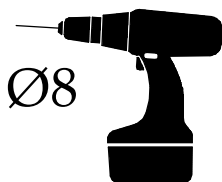
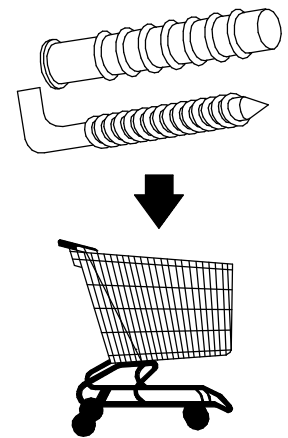
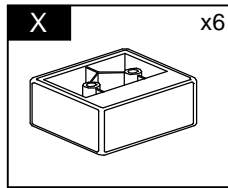
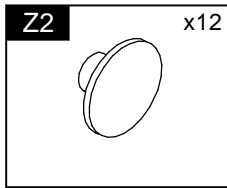
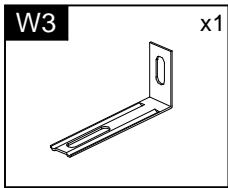
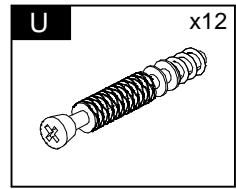
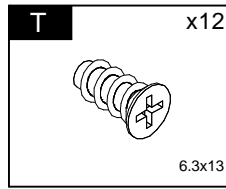
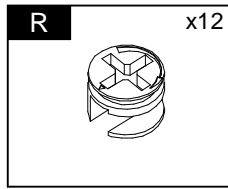
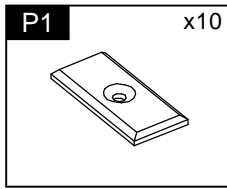
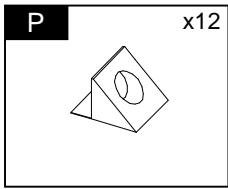
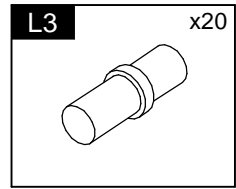
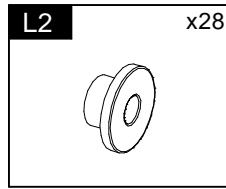
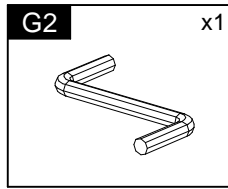
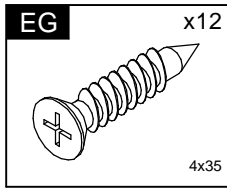
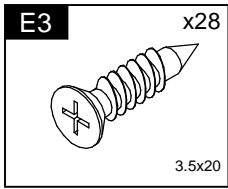
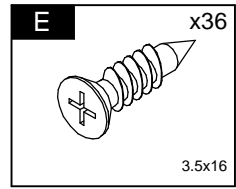
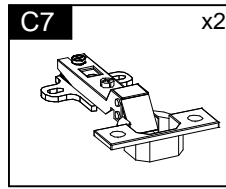
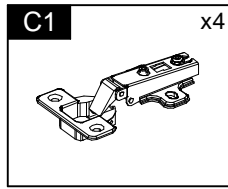
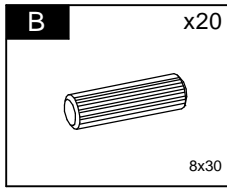
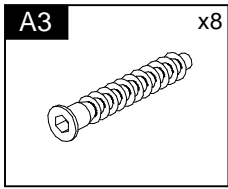
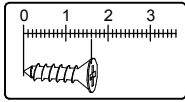

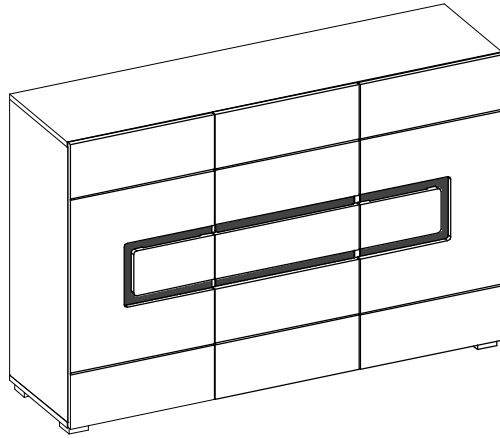

Element symbol	Measurements				Code	Paket
1	837	356.5	16	1	1004	1/3
2	837	356.5	16	1	1005	1/3
3	1345	357	16	1	1022	1/3
4	1345	357	16	1	1023	1/3
5	837	336.5	16	1	1006	1/3
6	837	336.5	16	1	1007	1/3
7	432	331	16	1	1001	1/3
8	432	320	16	1	N/A	1/3
9	423	320	16	4	N/A	1/3
10	867	447	3	2	N/A	1/3
11	867	448	3	1	1008	1/3
12	867	447	16	2	1001/3024	2/3
13	251	136	16	2	1002/3023	2/3
14	447	337	16	1	1009/3015	2/3
15	447	337	16	1	1009/3016	2/3
16	447	136	16	1	1010/3019	2/3
17	428	250	4	1	Glass	3/3
18	285	250	4	2	Glass	3/3

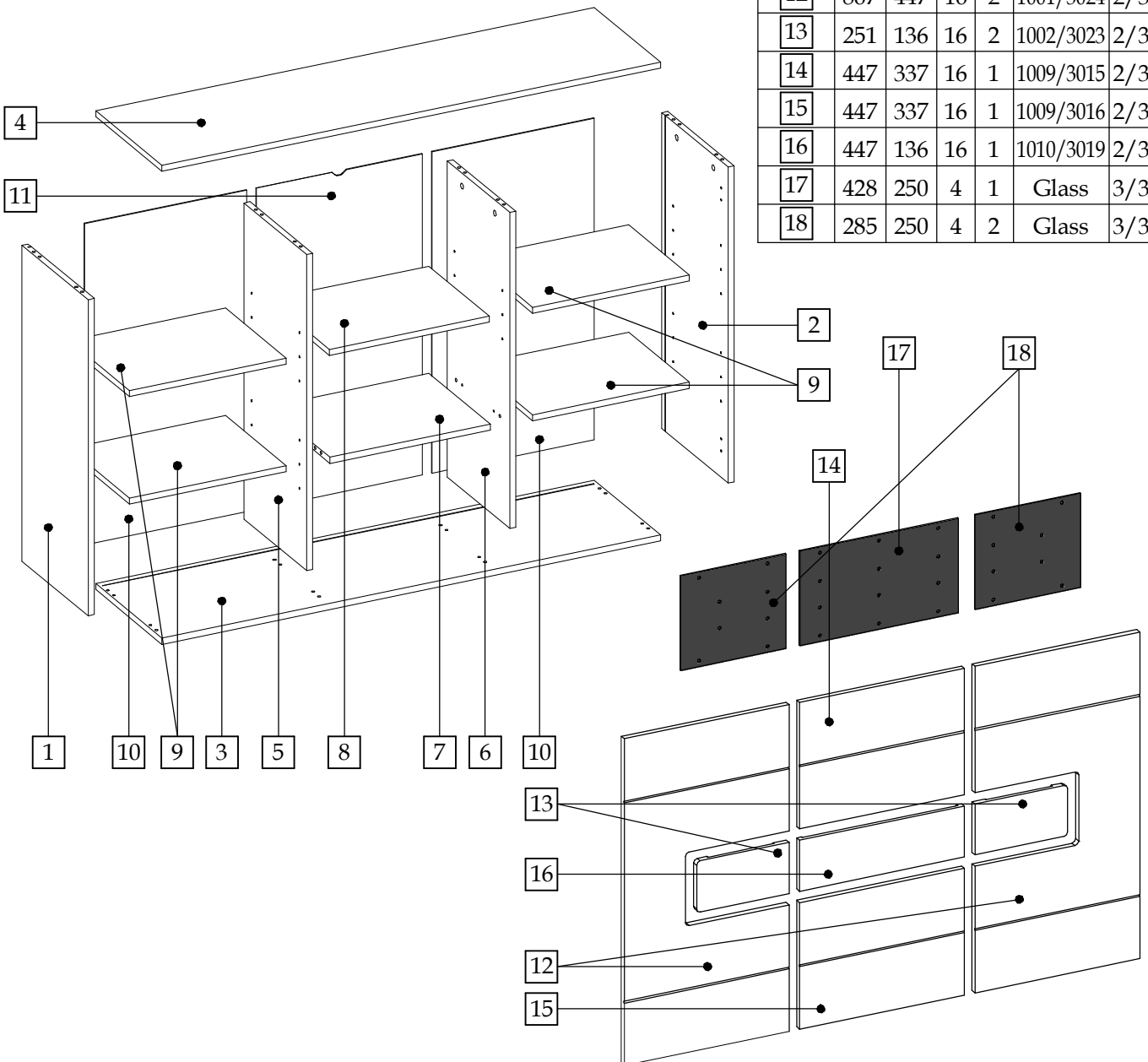

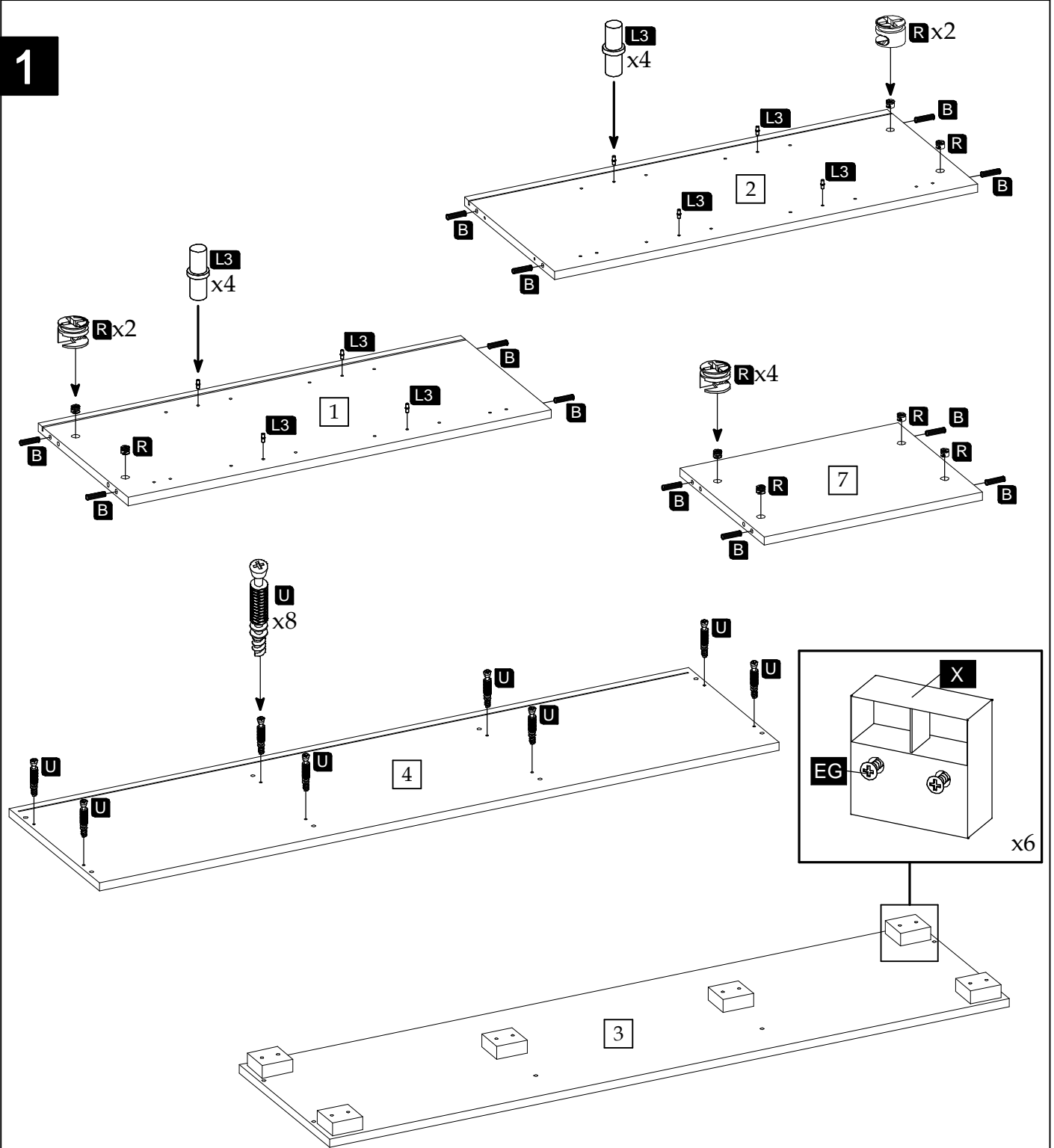

2

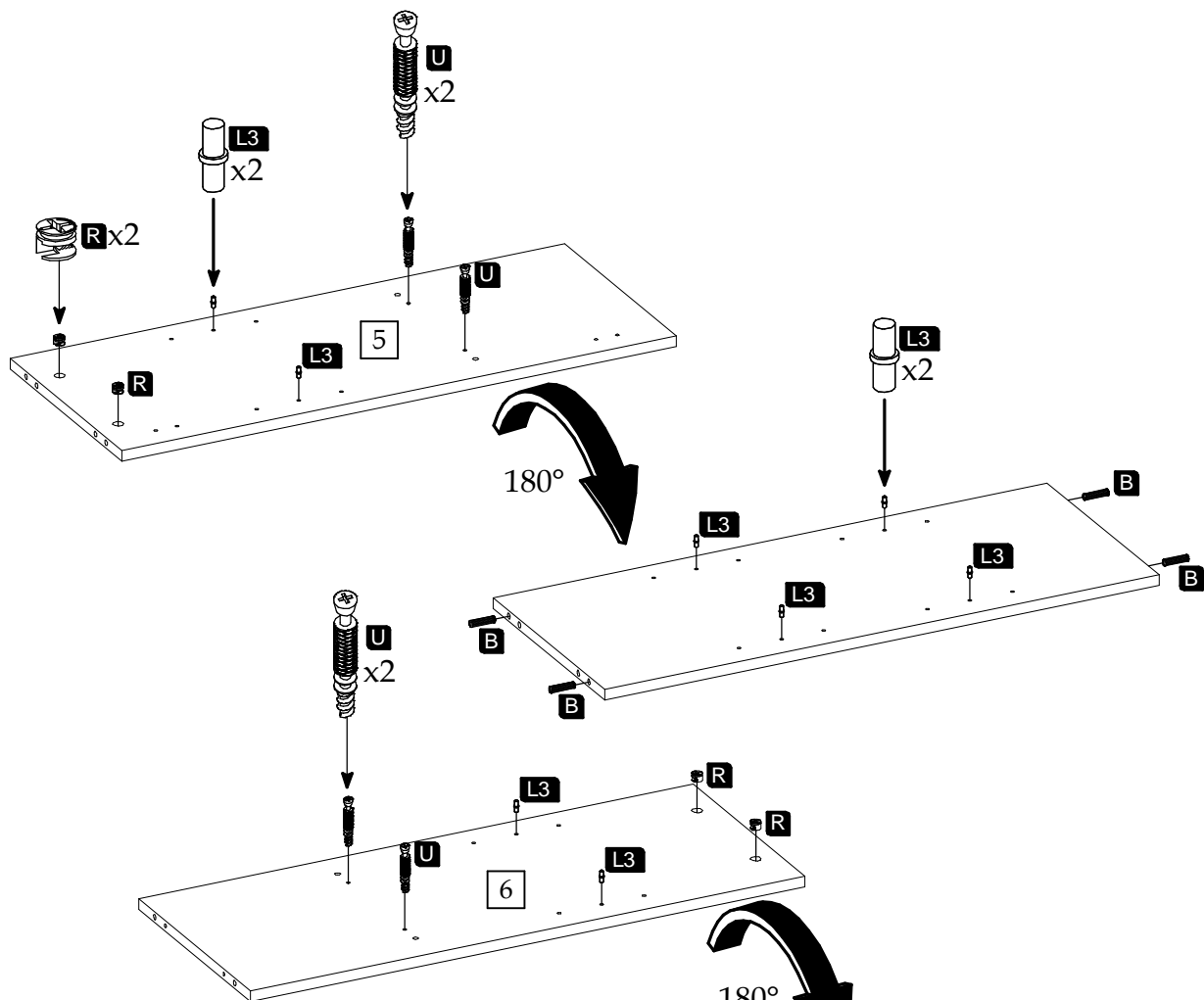

3

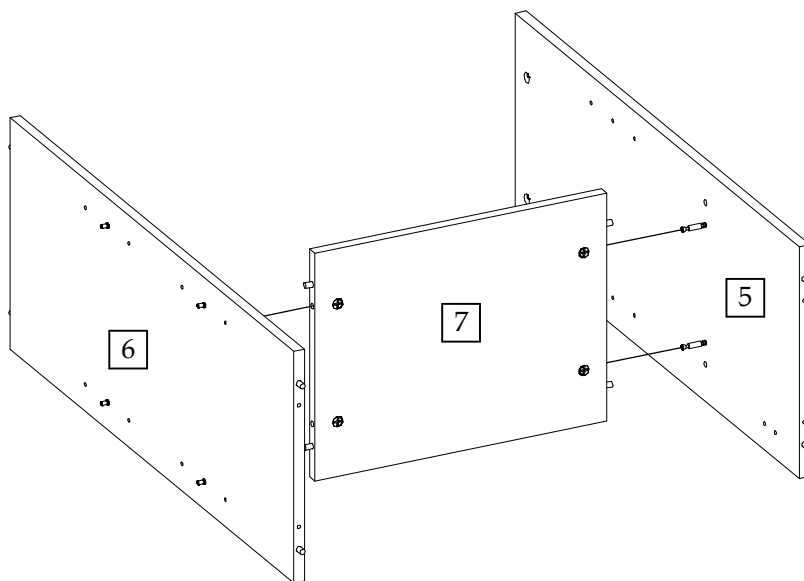
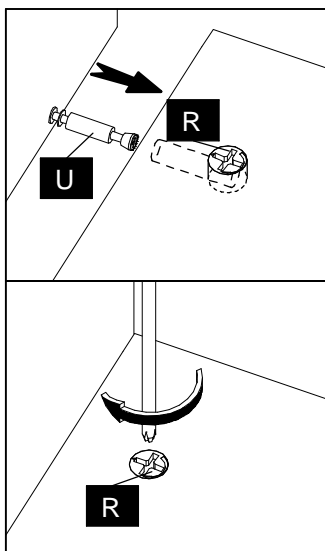
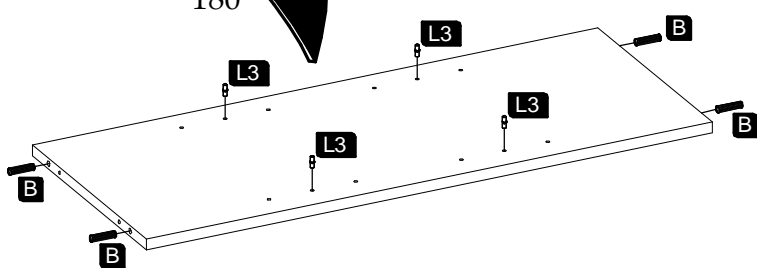

4

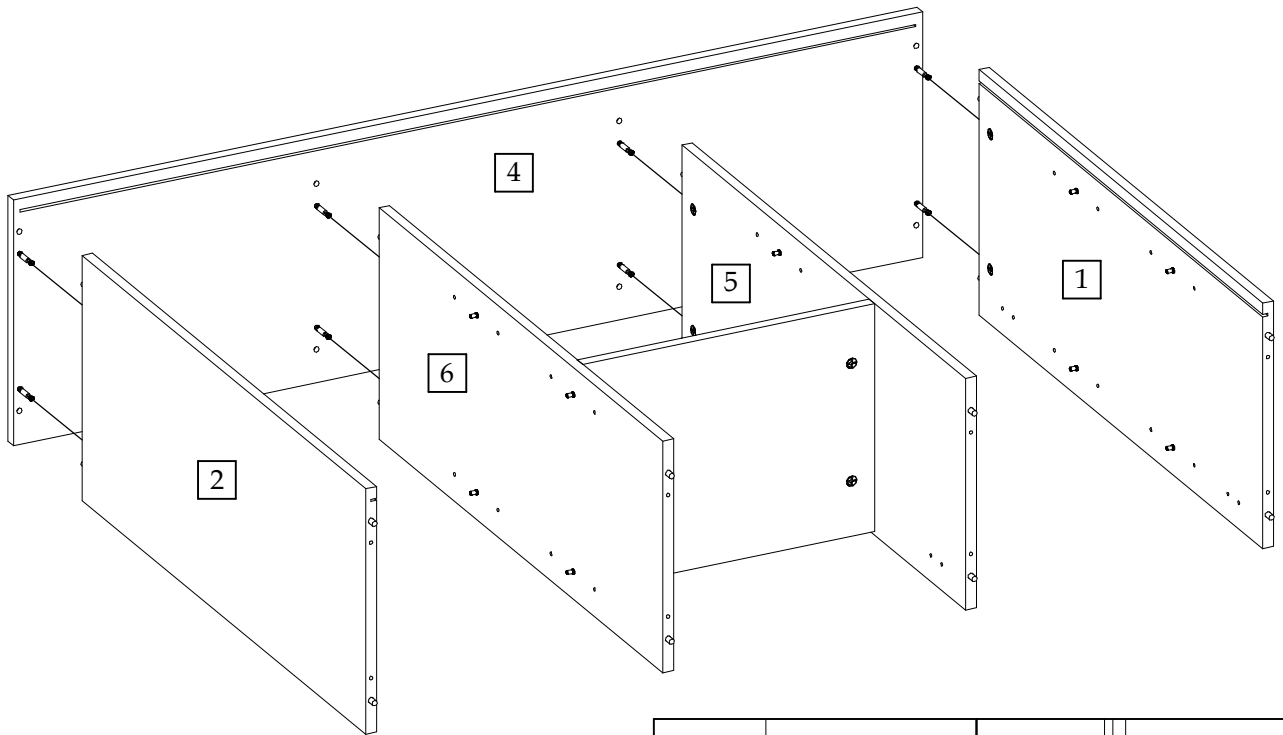

5

