

PAWEL

Typ F

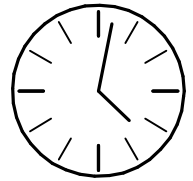

65 min

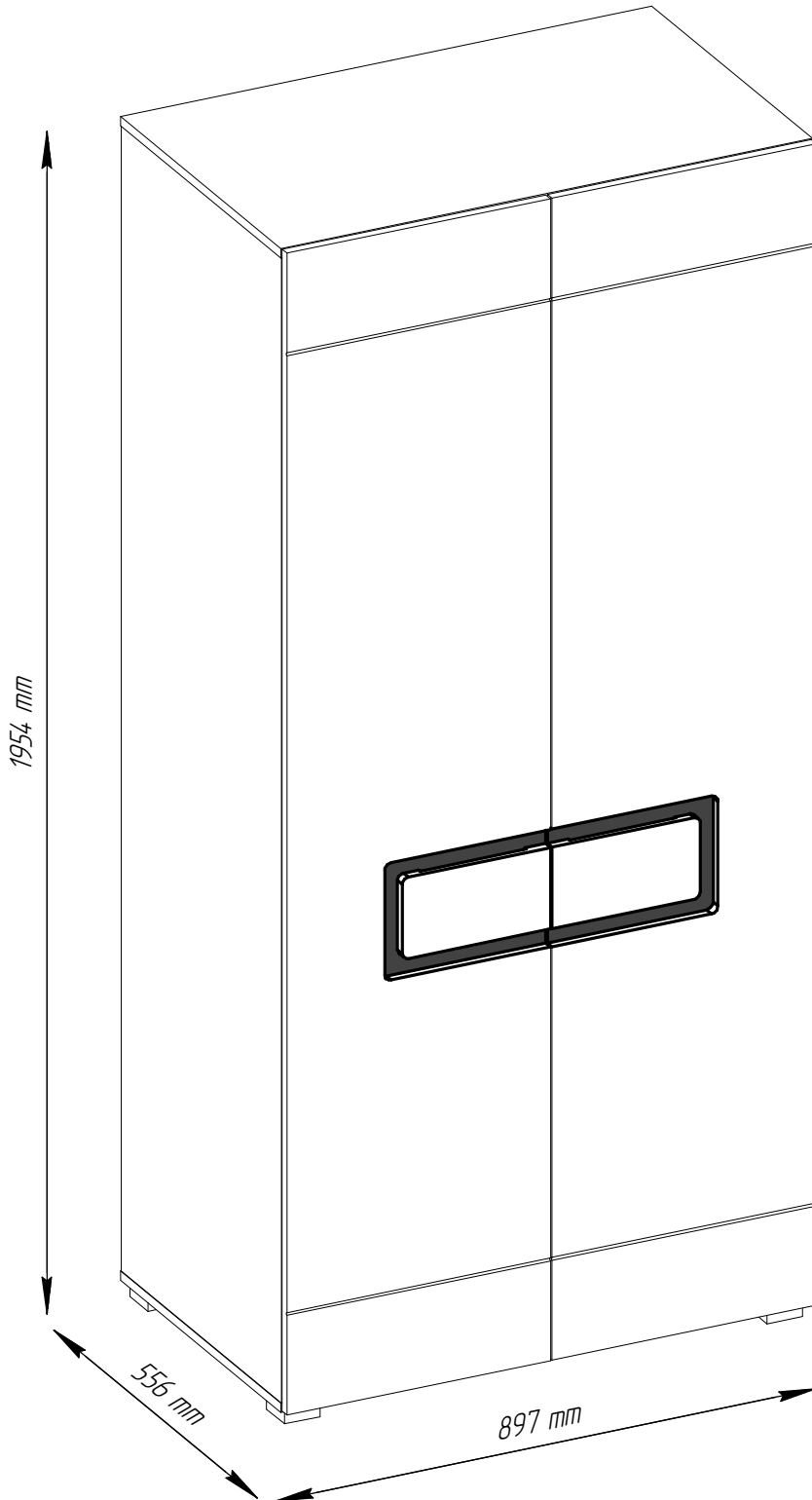
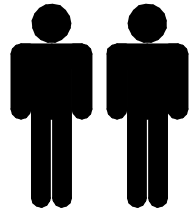

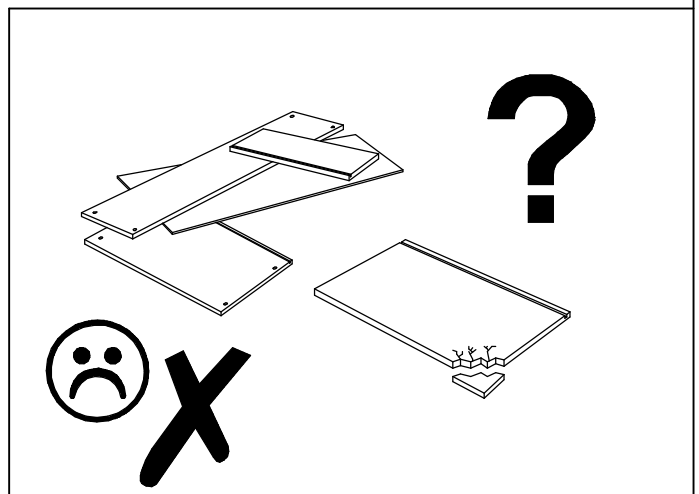
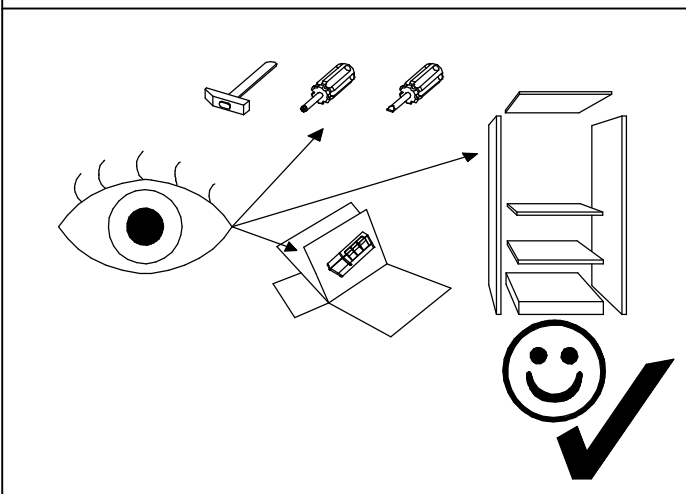
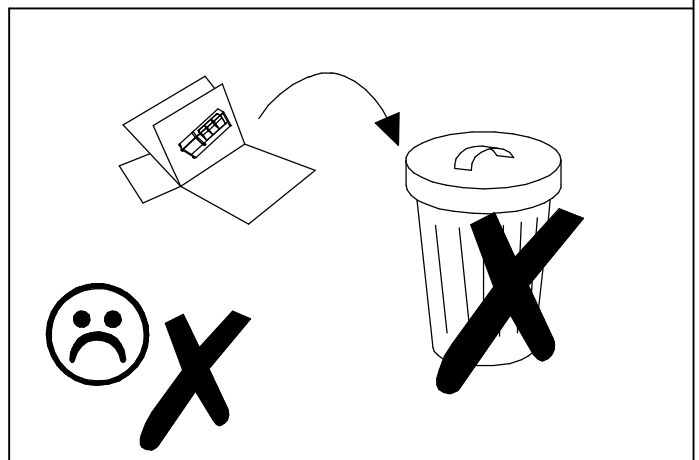
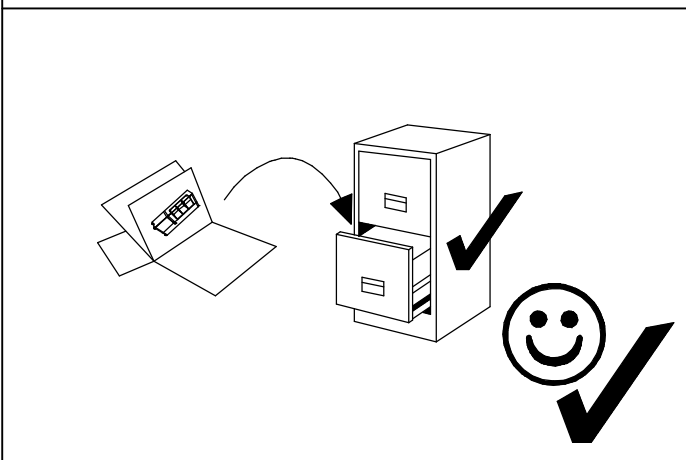
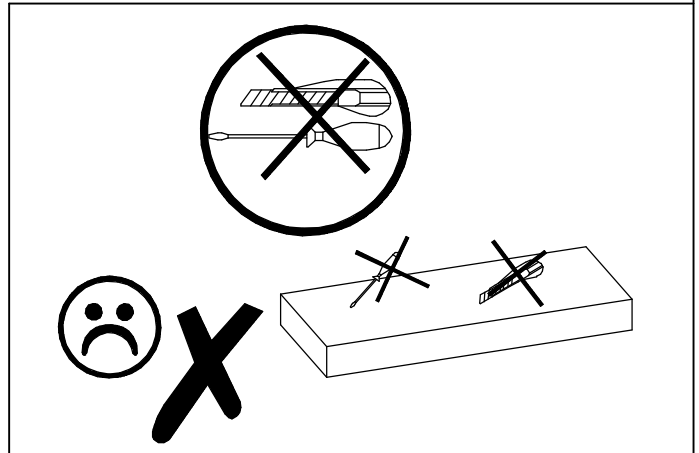
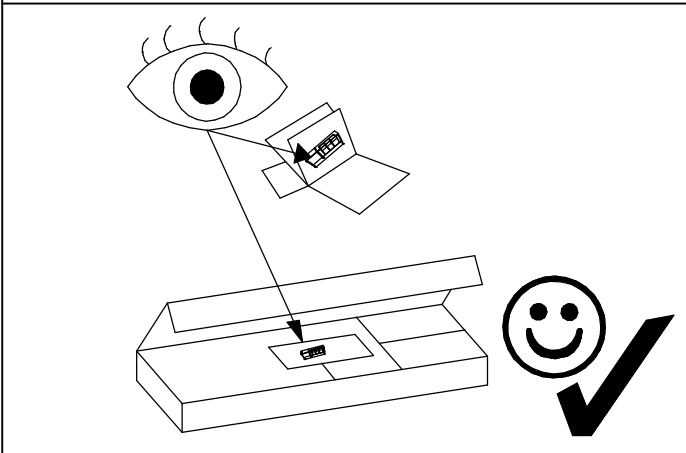

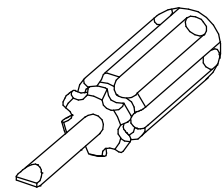
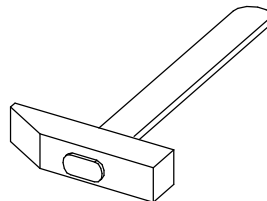
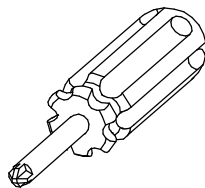
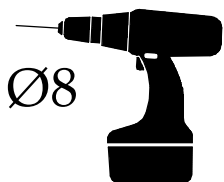
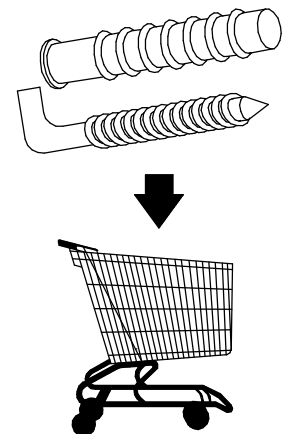
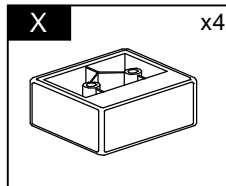
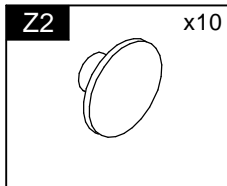
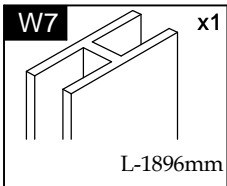
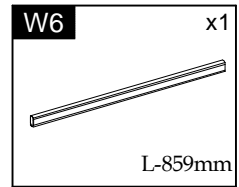
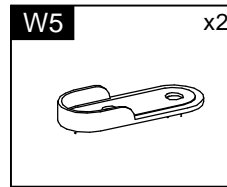
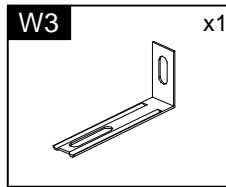
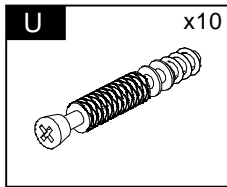
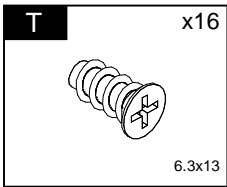
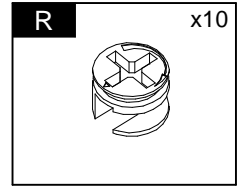
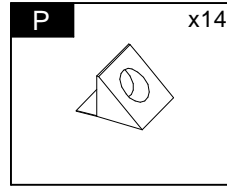
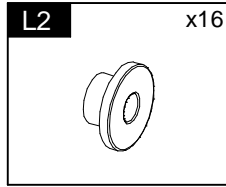
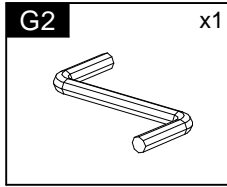
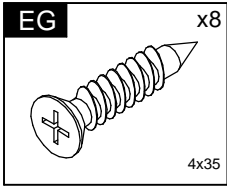
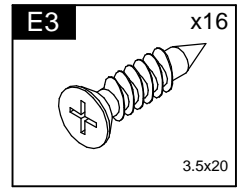
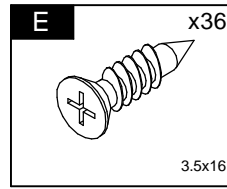
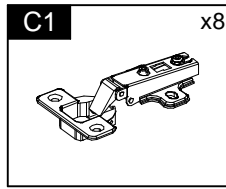
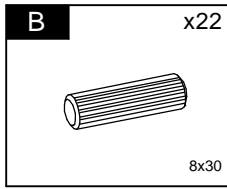
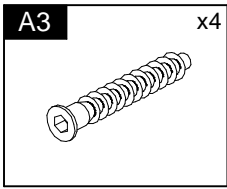
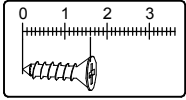

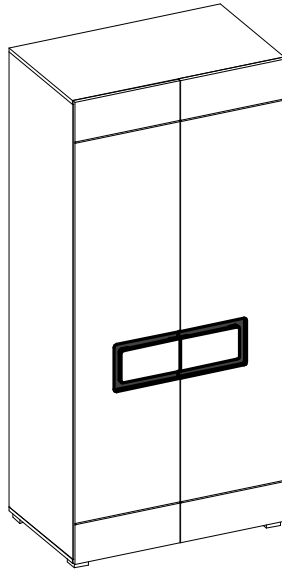

Element symbol	Measurements				Code	Paket
1	1897	540	16	1	1004	1/3
2	1897	540	16	1	1005	1/3
3	897	540	16	1	1026	1/3
4	897	540	16	1	1027	1/3
5	863	519.5	16	1	1022	1/3
6	863	96	16	1	1025	1/3
7	1911	438	3	2	N/A	1/3
8	1927	447	16	1	1029/3024	2/3
9	1927	447	16	1	1030/3025	2/3
10	251	136	16	2	1002/3023	2/3
11	285	250	4	2	Glass	3/3

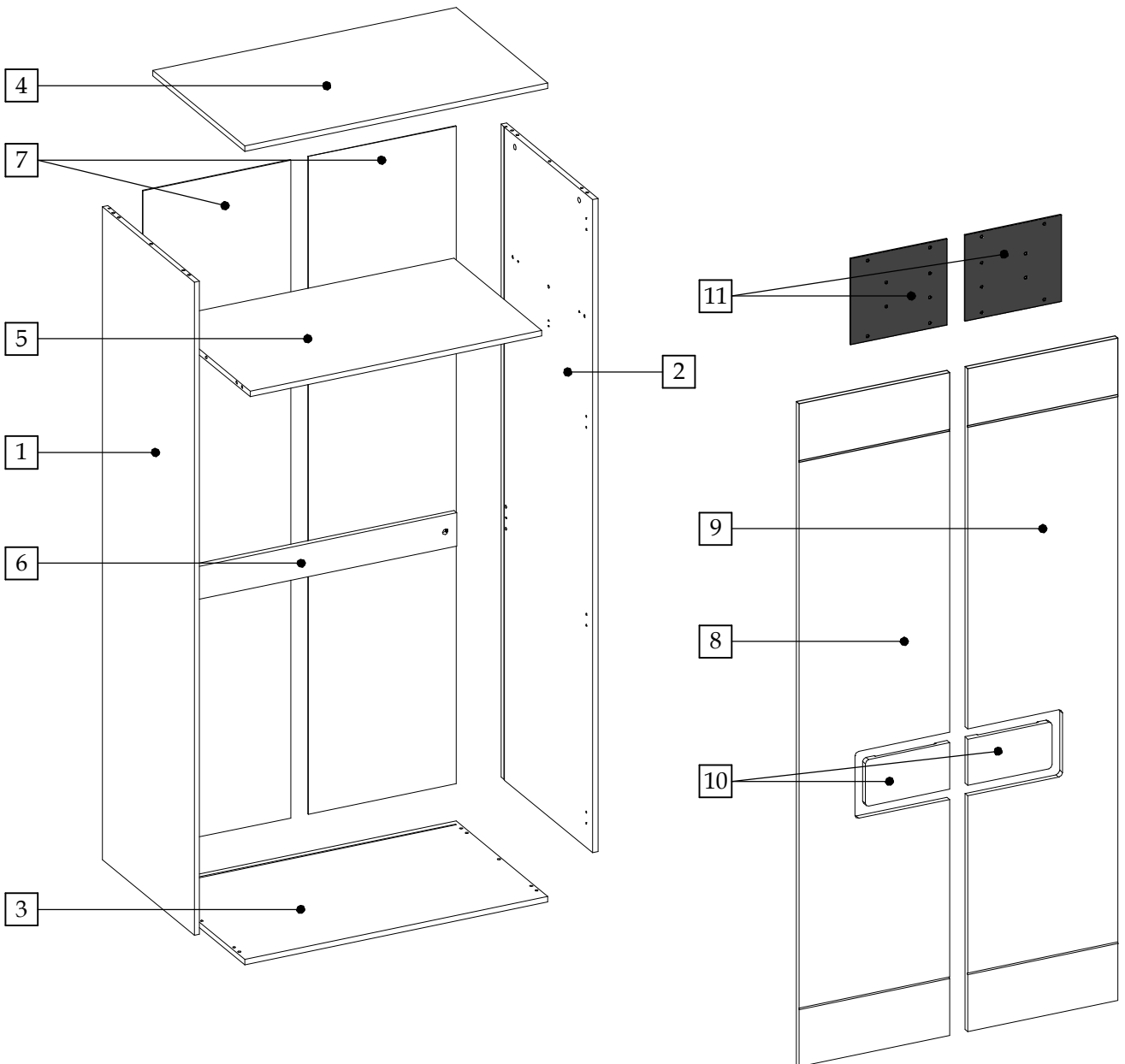



1

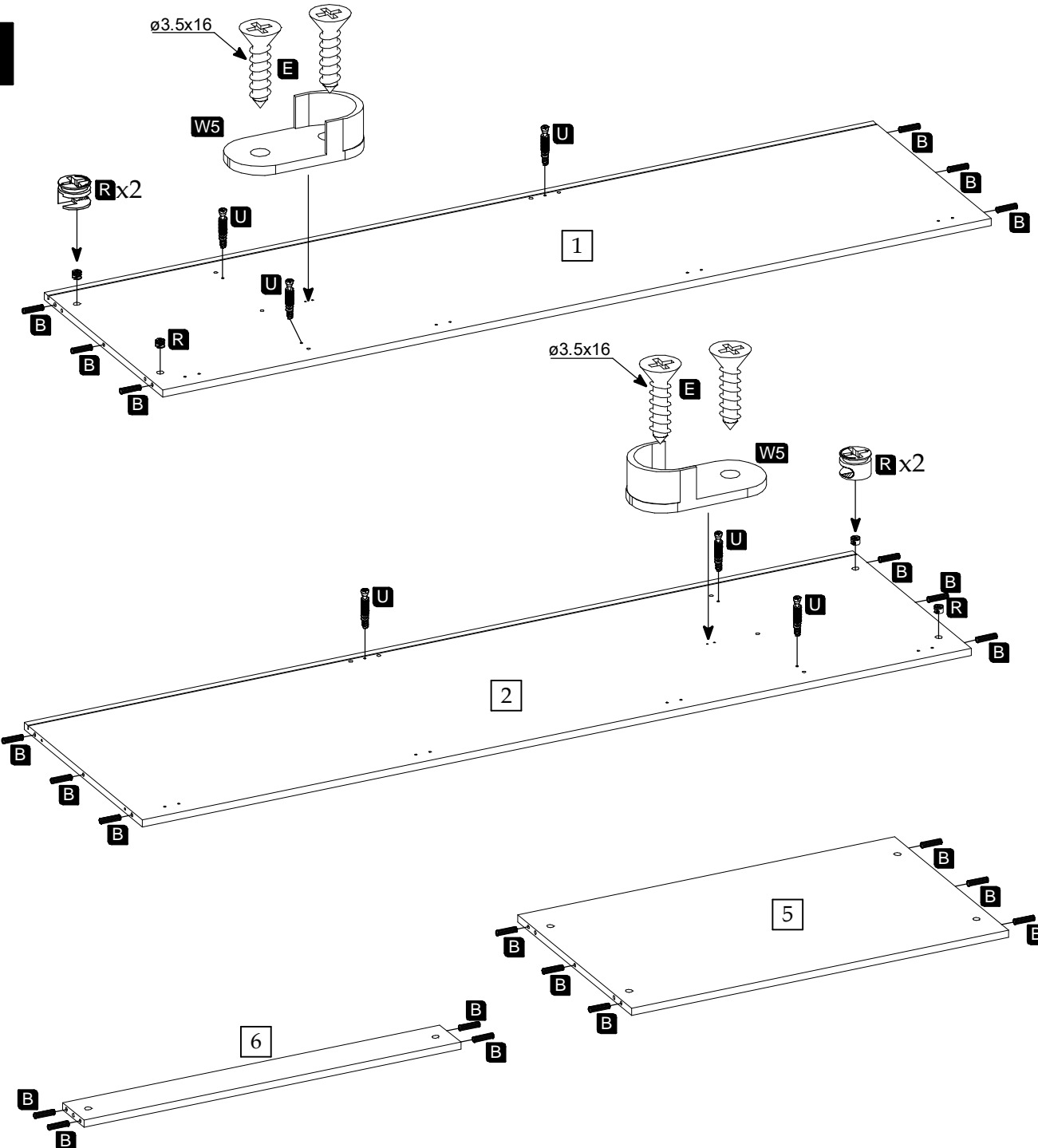

2

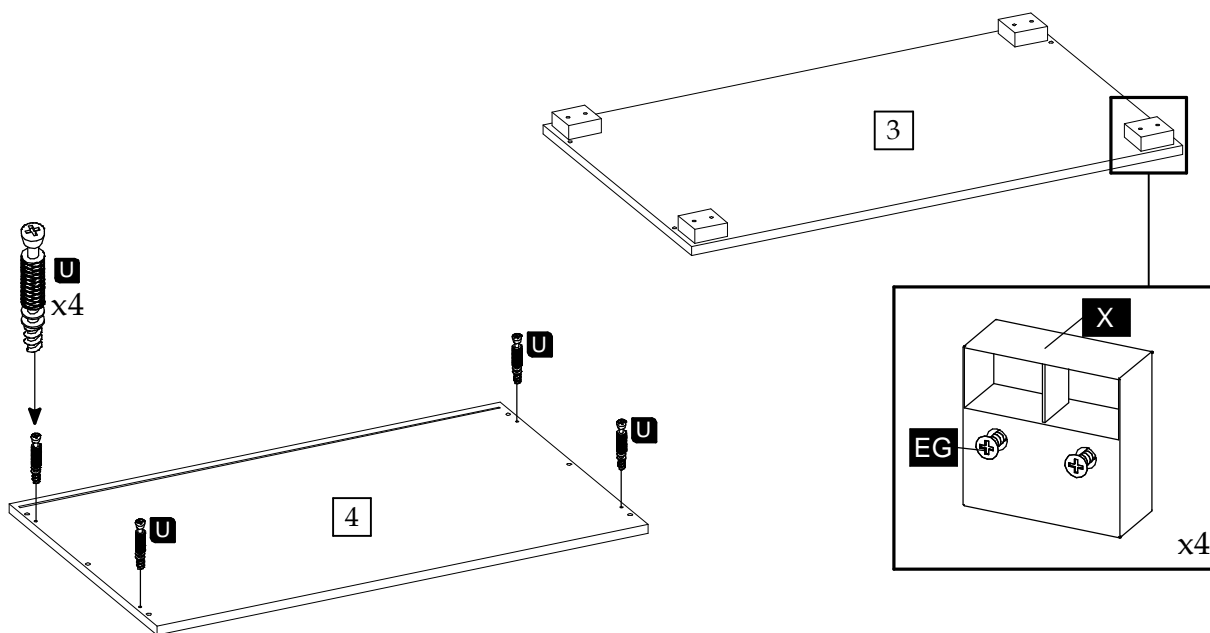

3

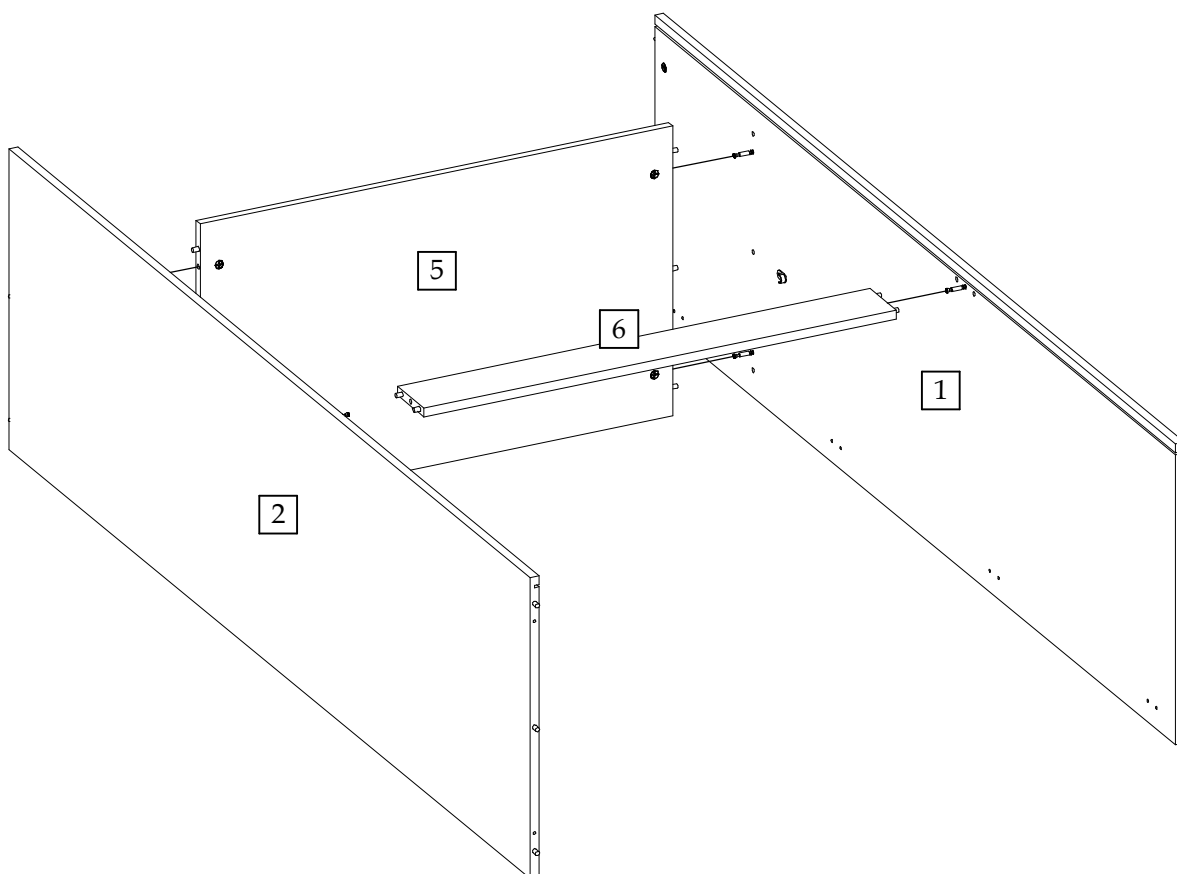

4

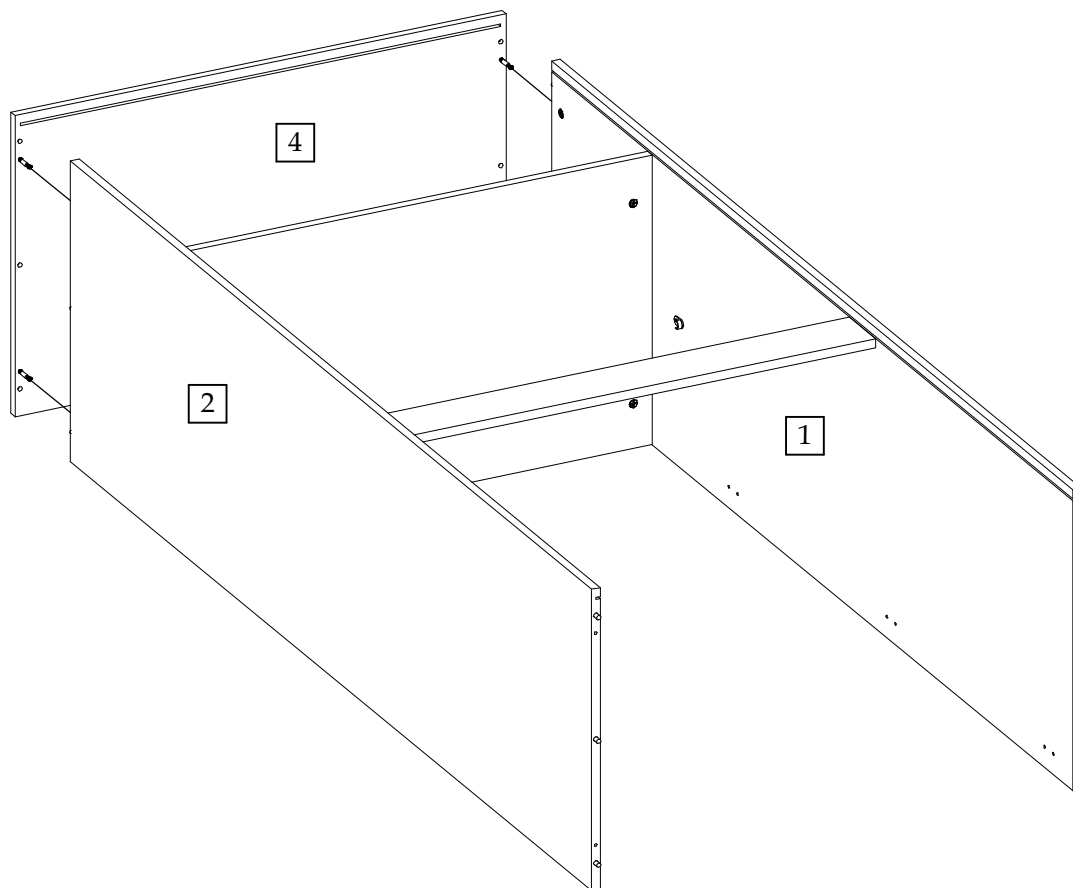

5

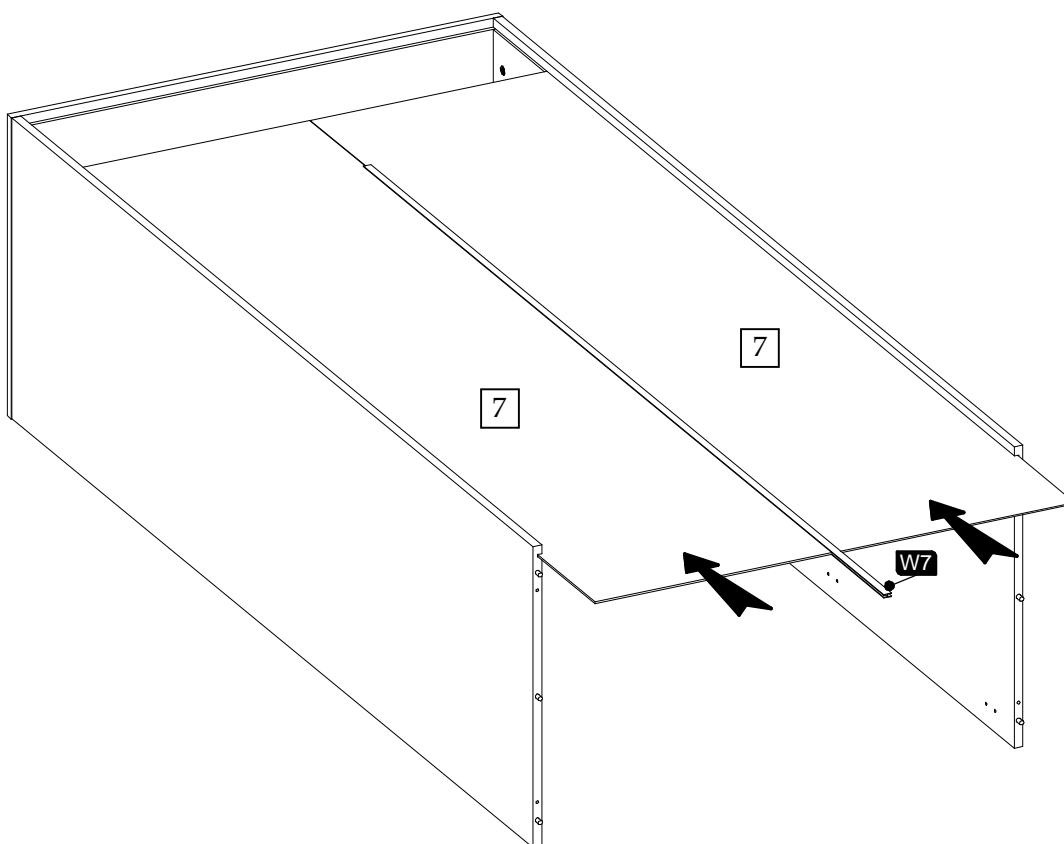

6

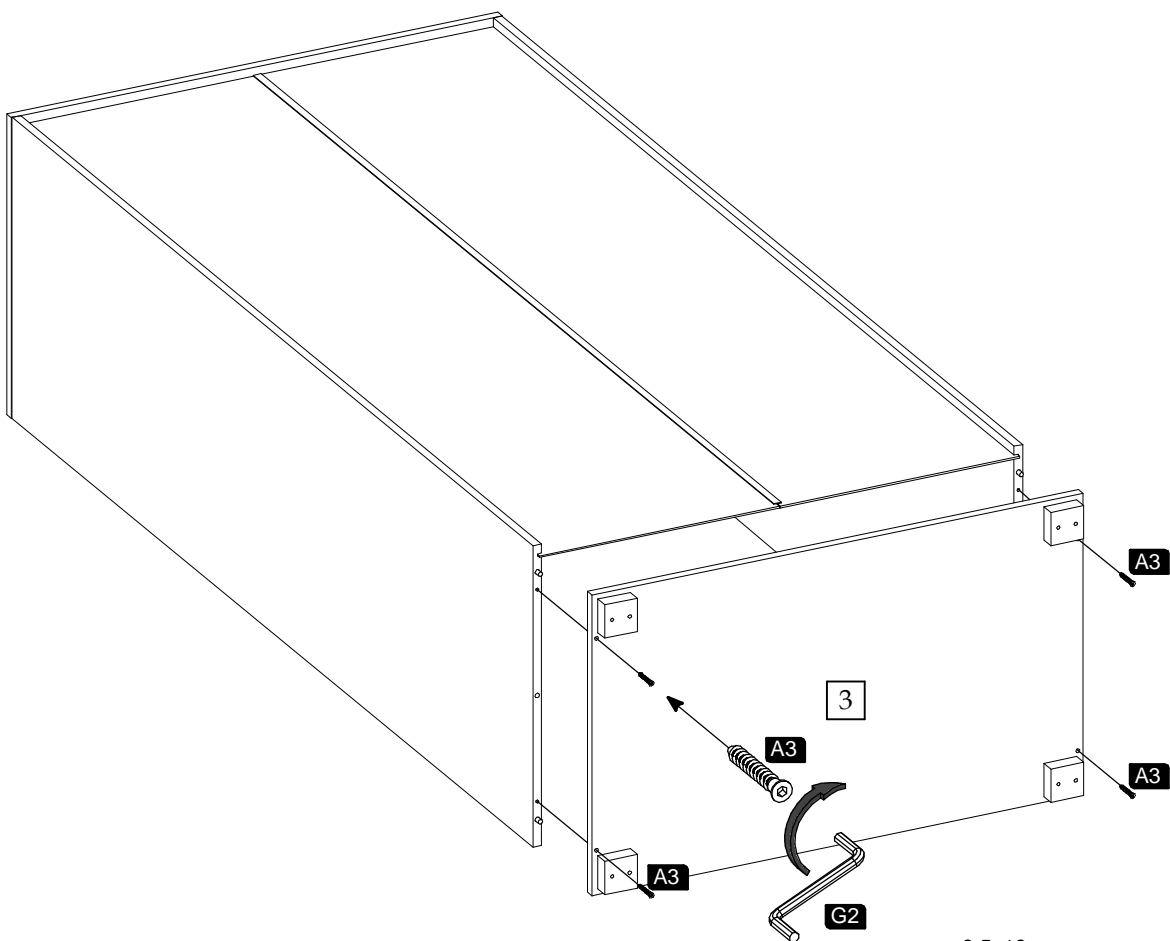

7

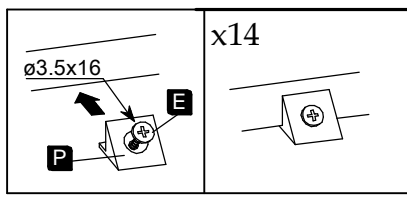
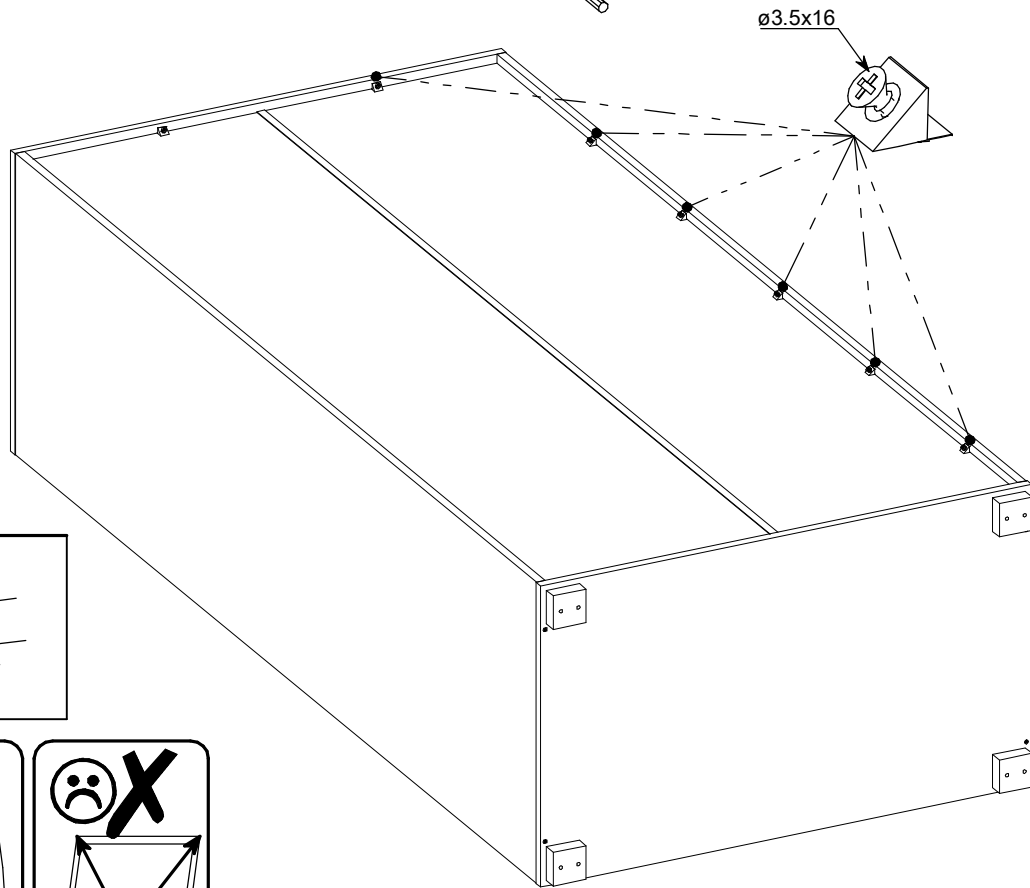

x14

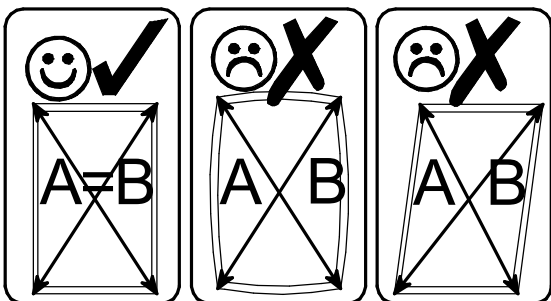

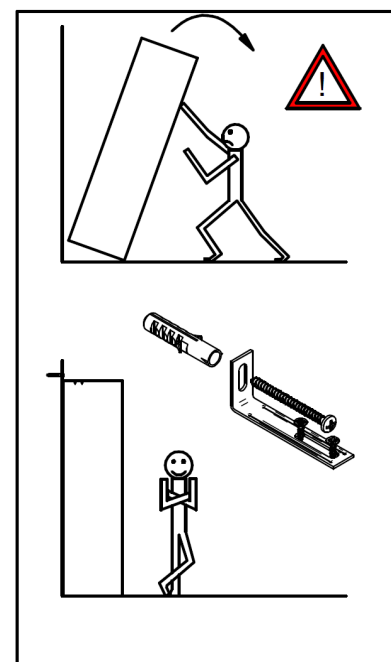
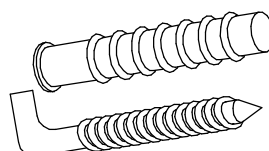
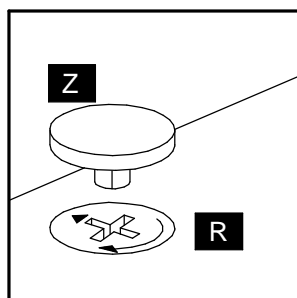
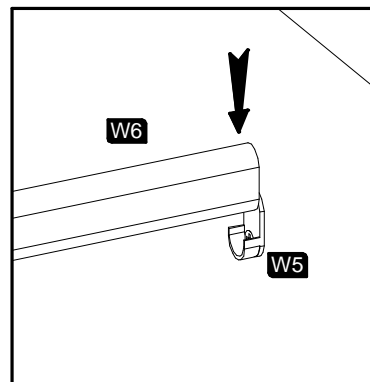
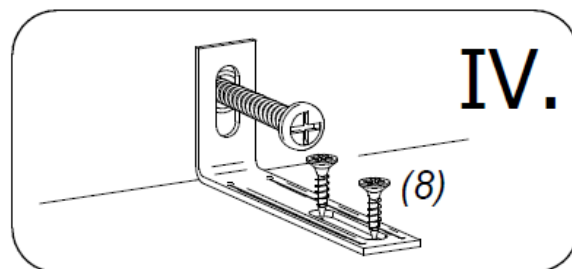
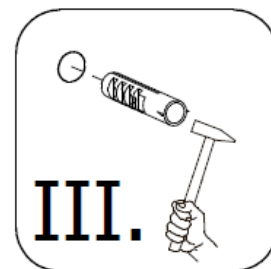
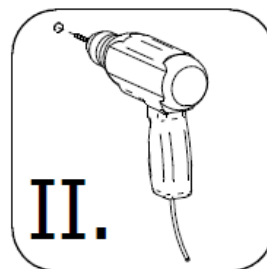
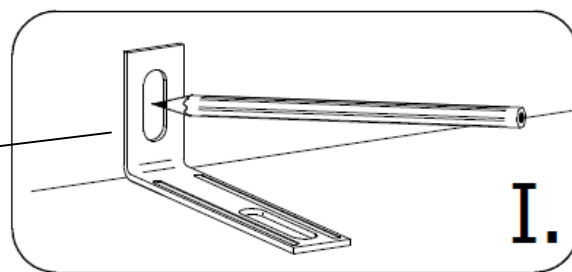
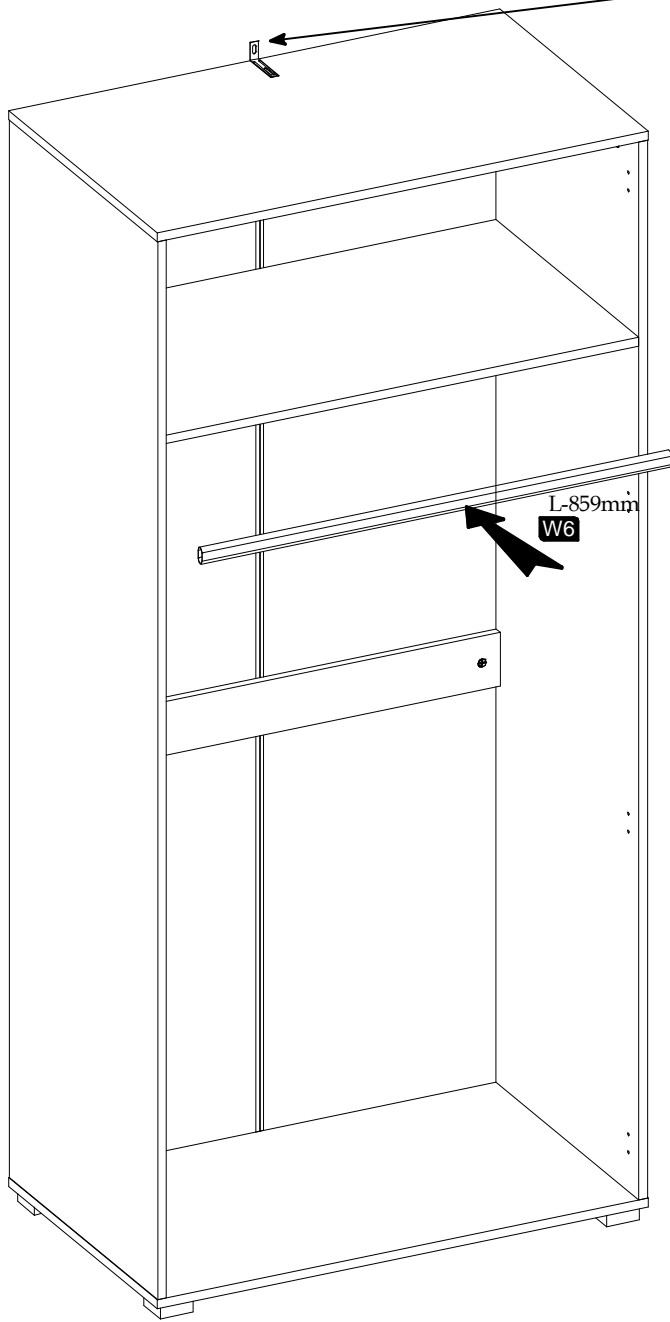

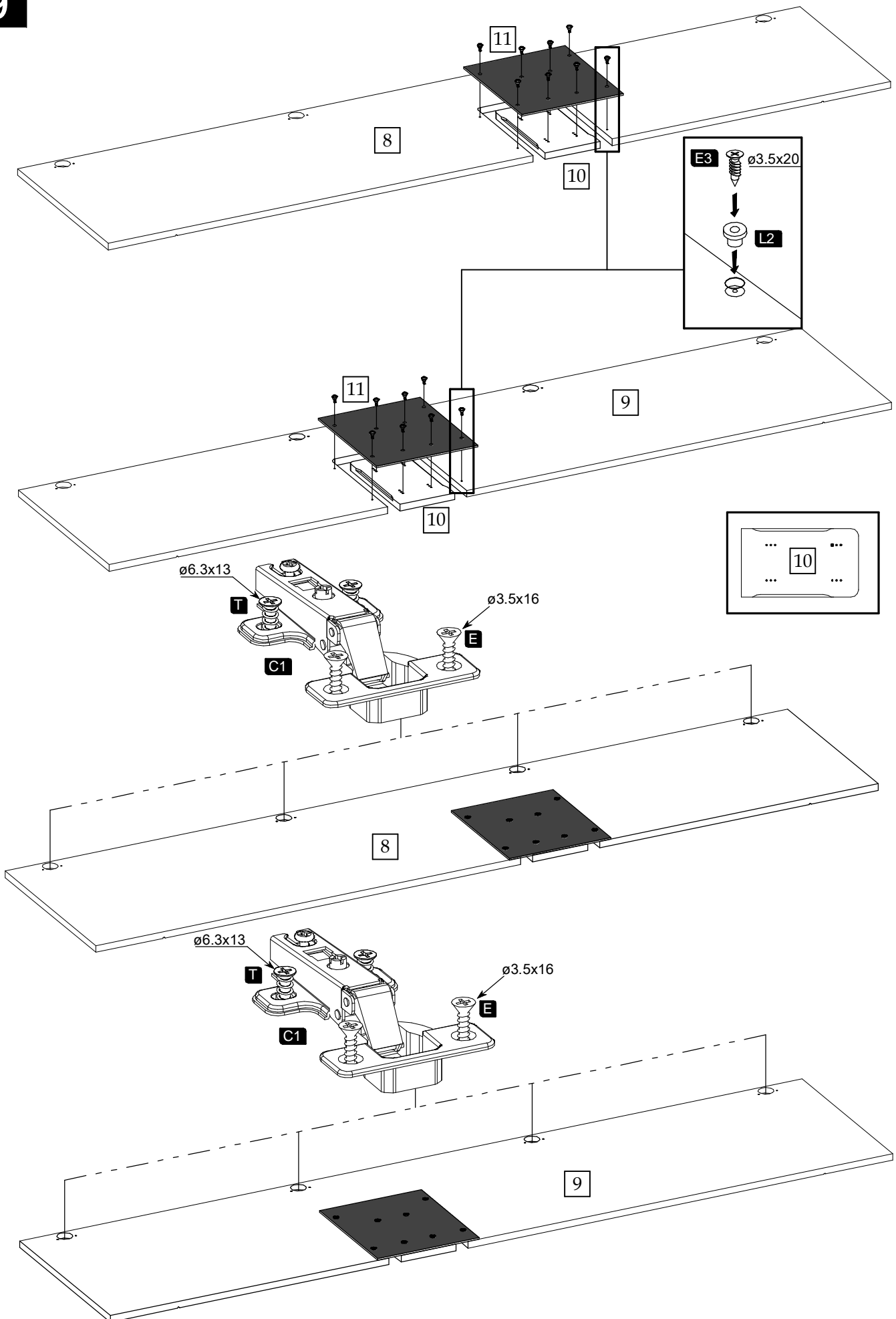

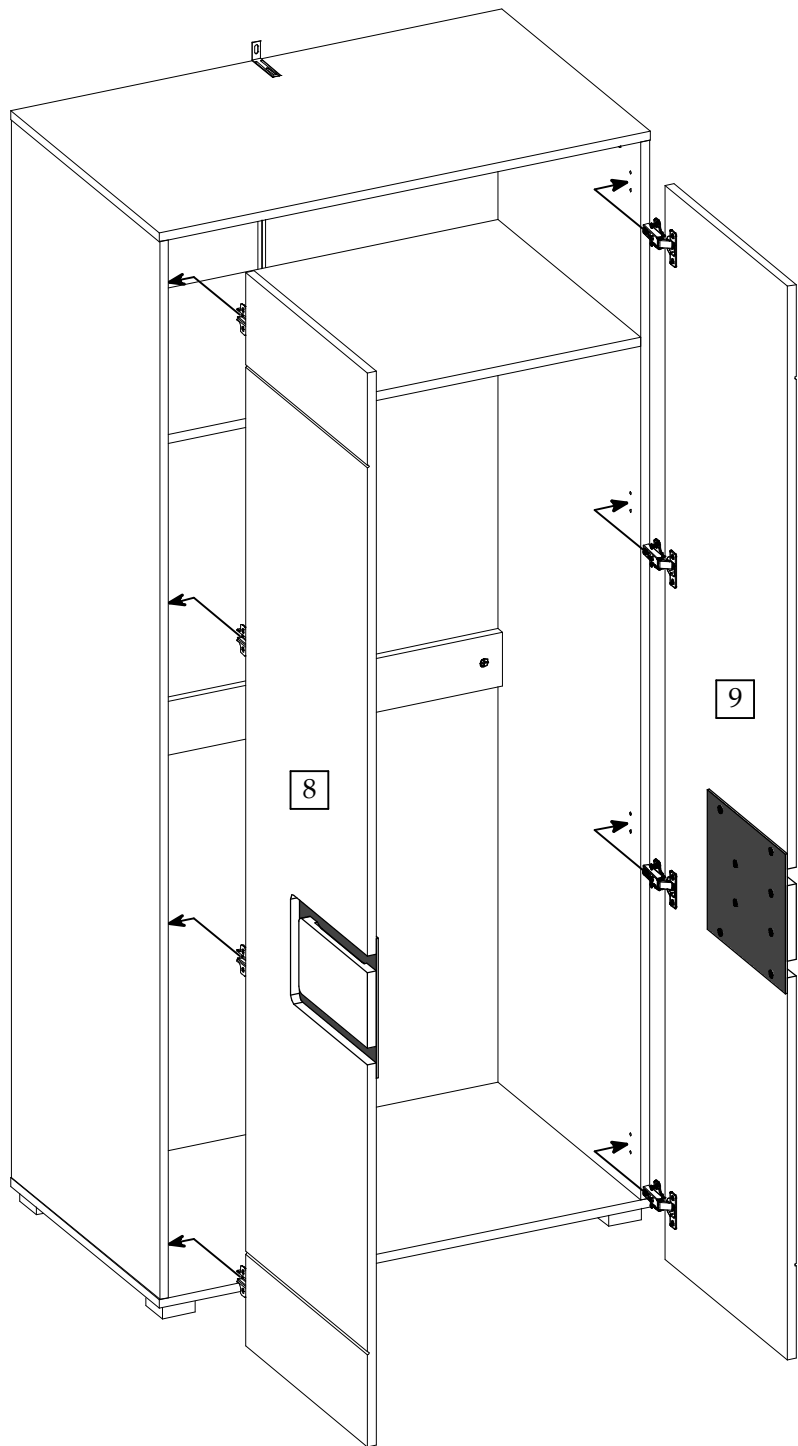

<p>Diagram B shows a hinge with two points labeled 'B'. A vertical double-headed arrow indicates the adjustment direction.</p>	<p>Diagram A shows a hinge with a point labeled 'A'. A horizontal double-headed arrow indicates the adjustment direction.</p>	<p>Diagram C shows a hinge with a point labeled 'C'. A diagonal double-headed arrow indicates the adjustment direction.</p>
<p>+ 2 mm - 2 mm</p> <p>A diagram of a cabinet door with a vertical red double-headed arrow between a '+' sign at the top and a '-' sign at the bottom.</p>	<p>+ 3 mm - 1 mm</p> <p>A diagram of a cabinet door with a horizontal red double-headed arrow between a '-' sign on the left and a '+' sign on the right.</p>	<p>+ 5 mm - 1,5 mm</p> <p>A diagram of a cabinet door with a diagonal red double-headed arrow between a '-' sign on the left and a '+' sign on the right.</p>

