

PAWEL

Typ R1

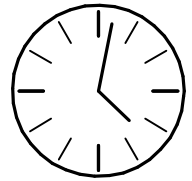

55 min

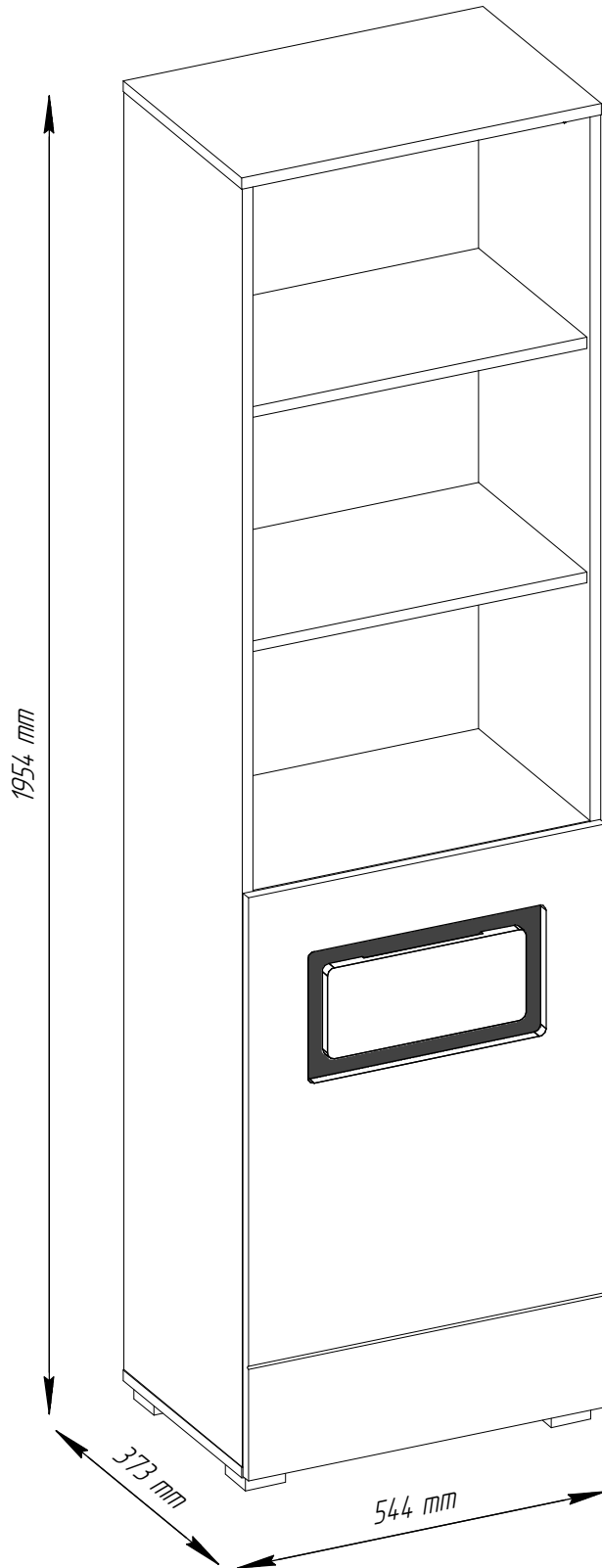
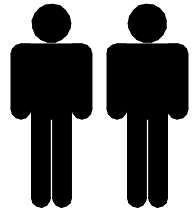

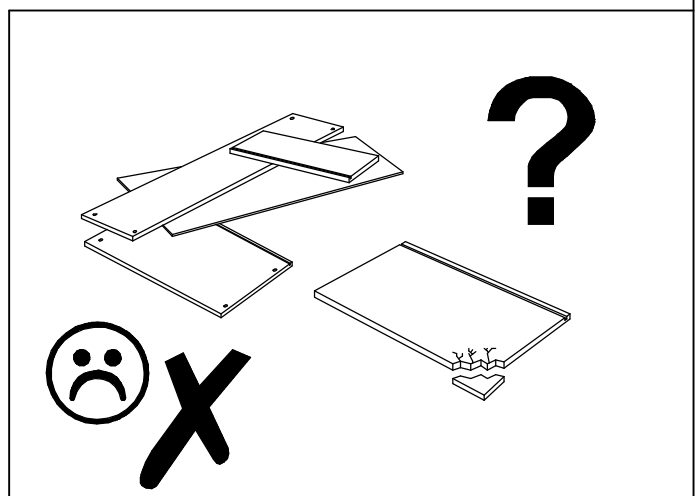
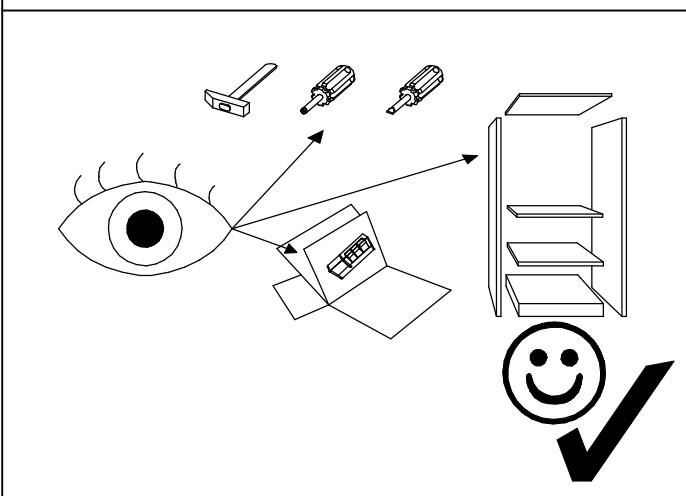
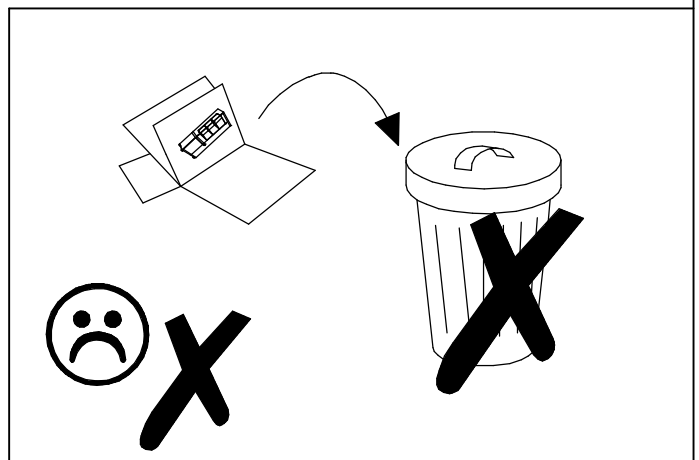
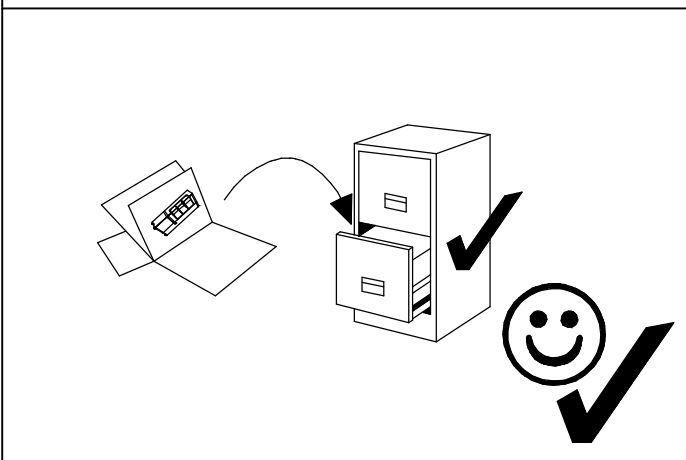
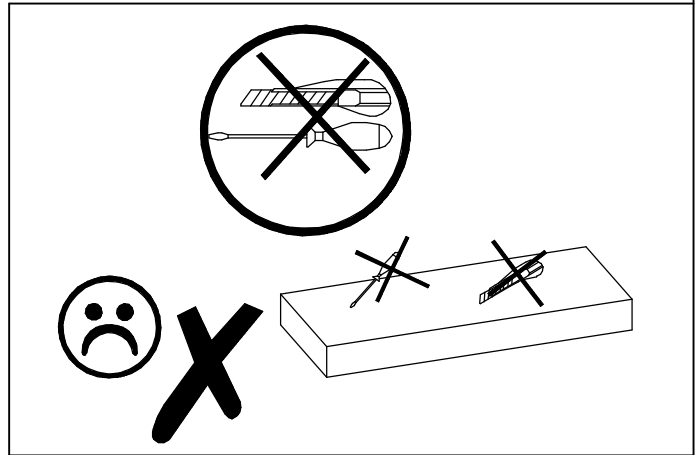
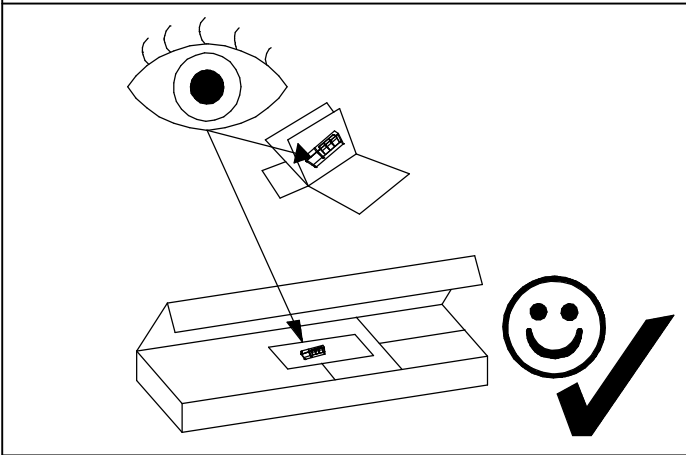

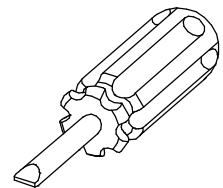
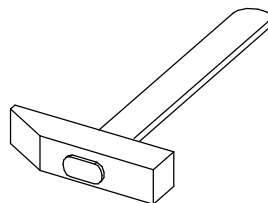
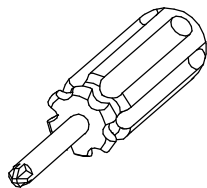
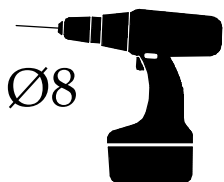
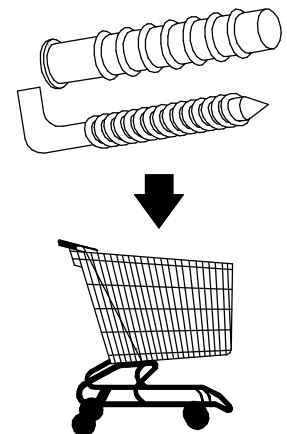
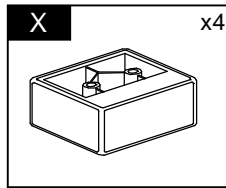
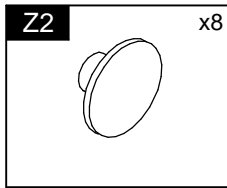
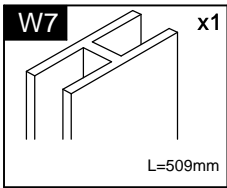
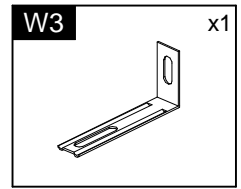
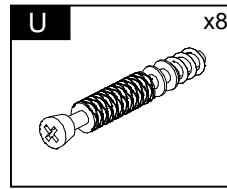
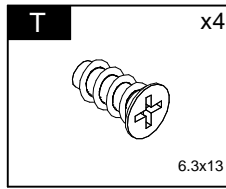
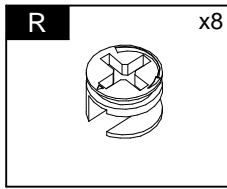
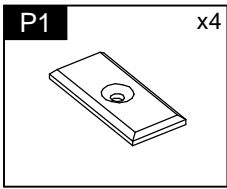
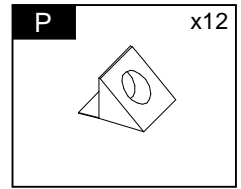
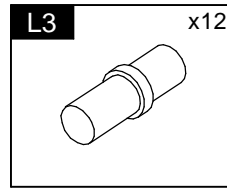
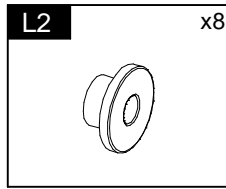
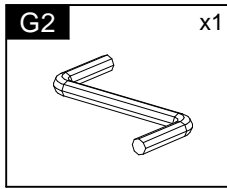
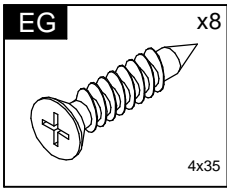
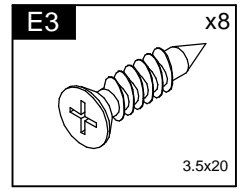
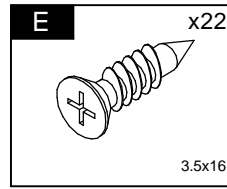
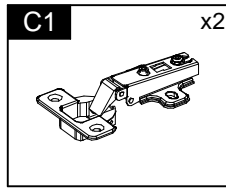
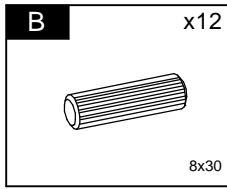
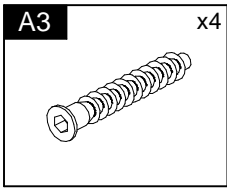
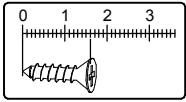

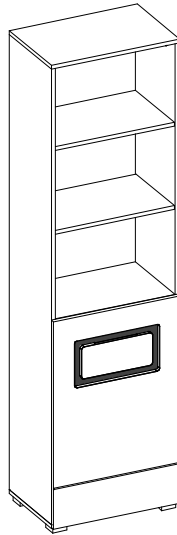

| Element symbol | Measurements | | | | Code | Paket |
|----------------|--------------|-------|----|---|-----------|-------|
| 1 | 1897 | 356.5 | 16 | 1 | 1004 | 1/3 |
| 2 | 1897 | 356.5 | 16 | 1 | 1005 | 1/3 |
| 3 | 544 | 357 | 16 | 1 | 1027 | 1/3 |
| 4 | 544 | 357 | 16 | 1 | 1028 | 1/3 |
| 5 | 510 | 336 | 16 | 1 | 1022 | 1/3 |
| 6 | 510 | 325 | 16 | 3 | N/A | 1/3 |
| 7 | 694 | 524 | 3 | 1 | N/A | 1/3 |
| 8 | 365 | 524 | 3 | 1 | N/A | 1/3 |
| 9 | 851 | 524 | 3 | 1 | N/A | 1/3 |
| 10 | 867 | 542 | 16 | 1 | 1005/3009 | 2/3 |
| 11 | 301 | 136 | 16 | 1 | 1003/3024 | 2/3 |
| 12 | 370 | 250 | 6 | 1 | Glass | 3/3 |

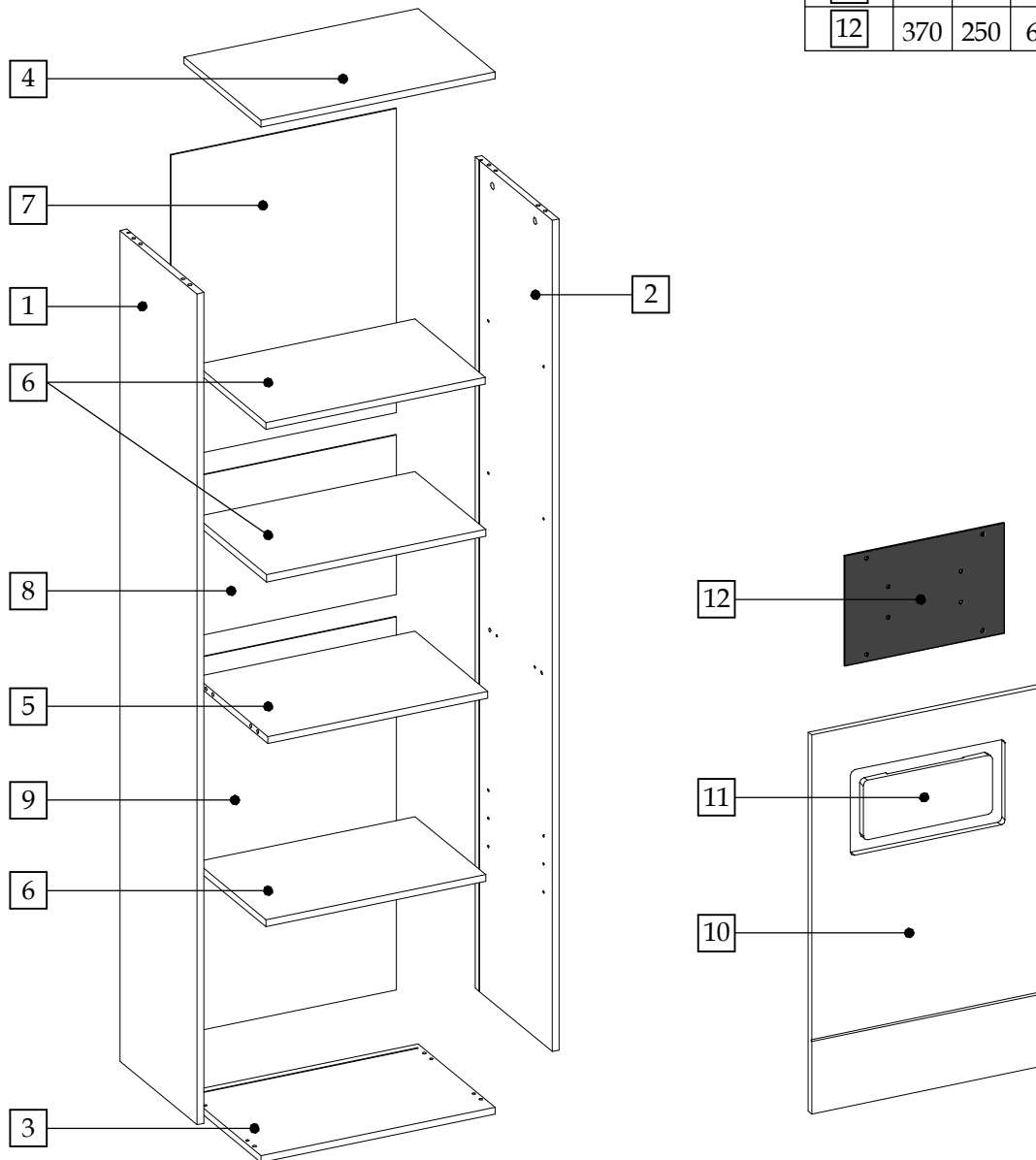

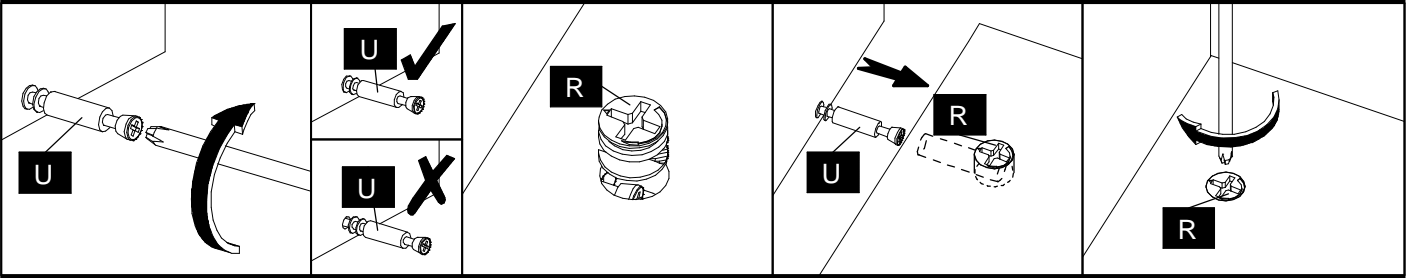

1

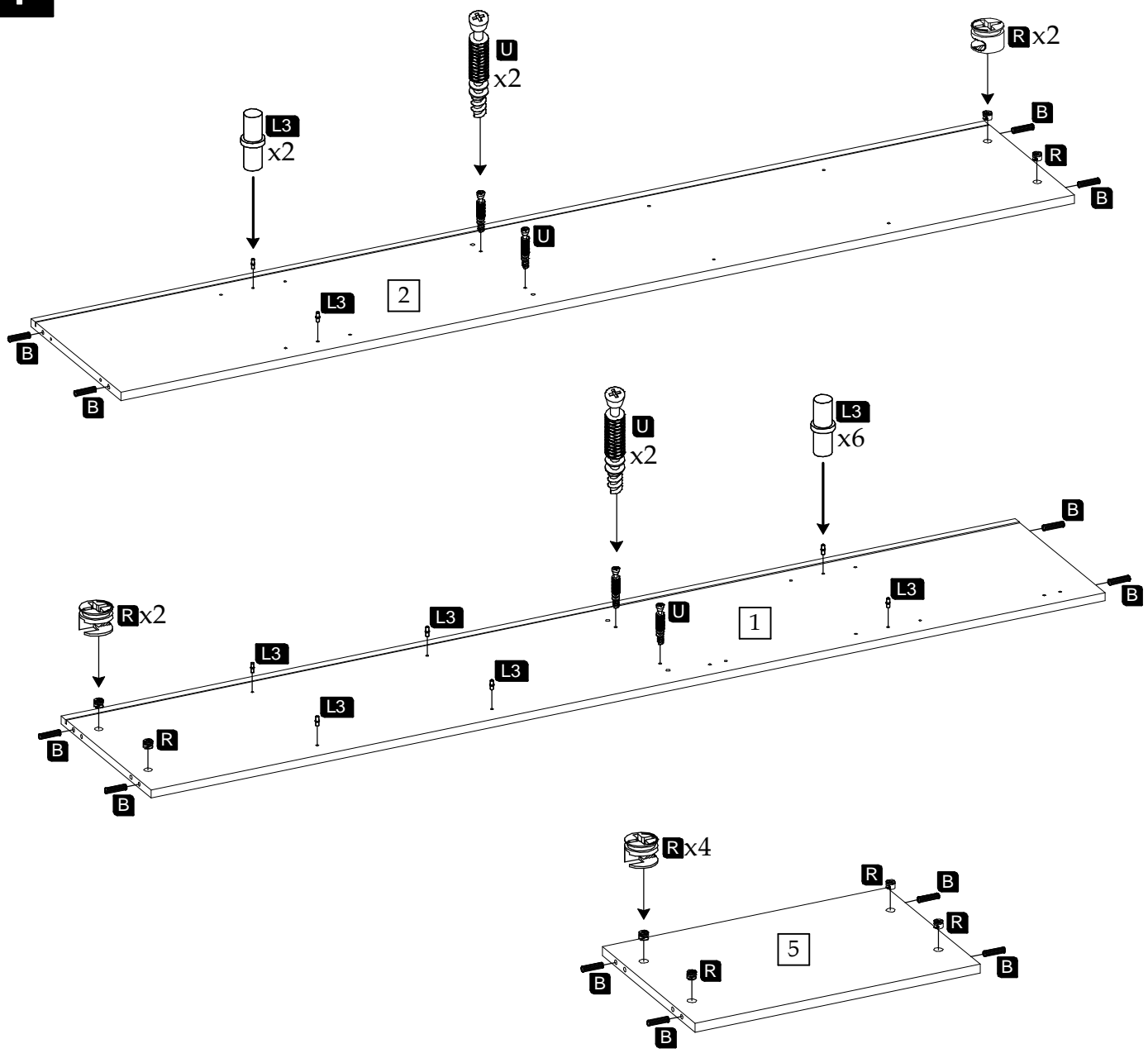

2

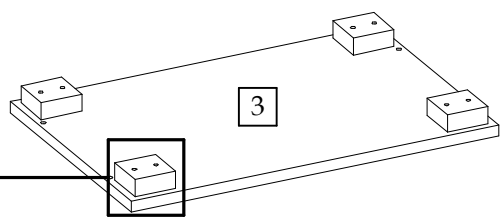
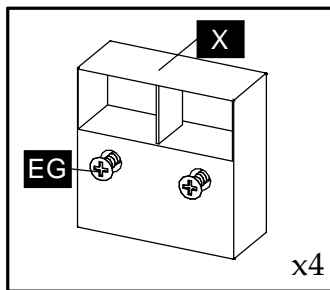
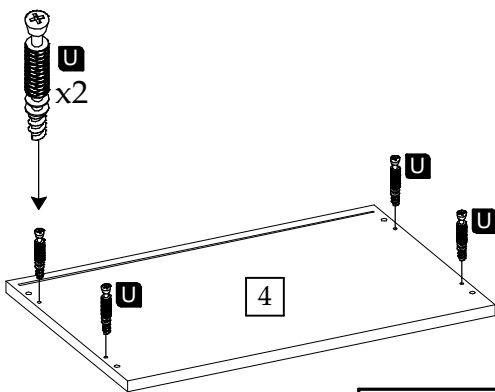

3

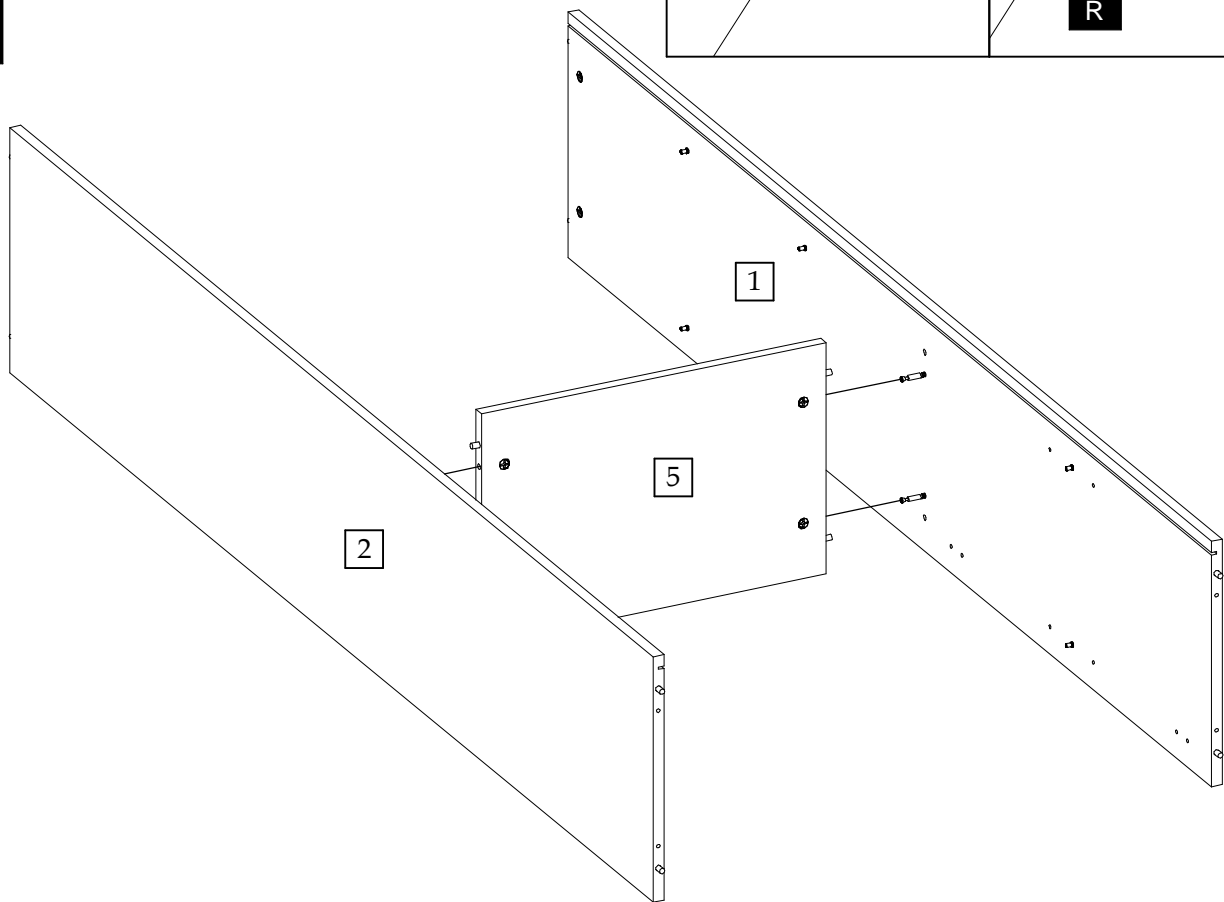
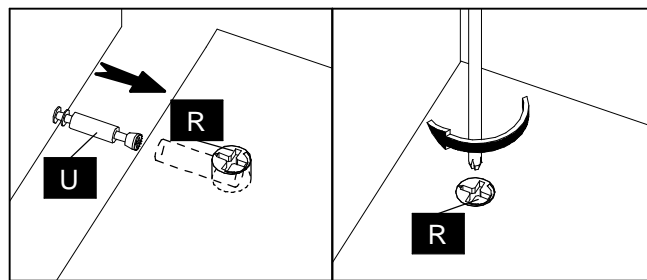

4

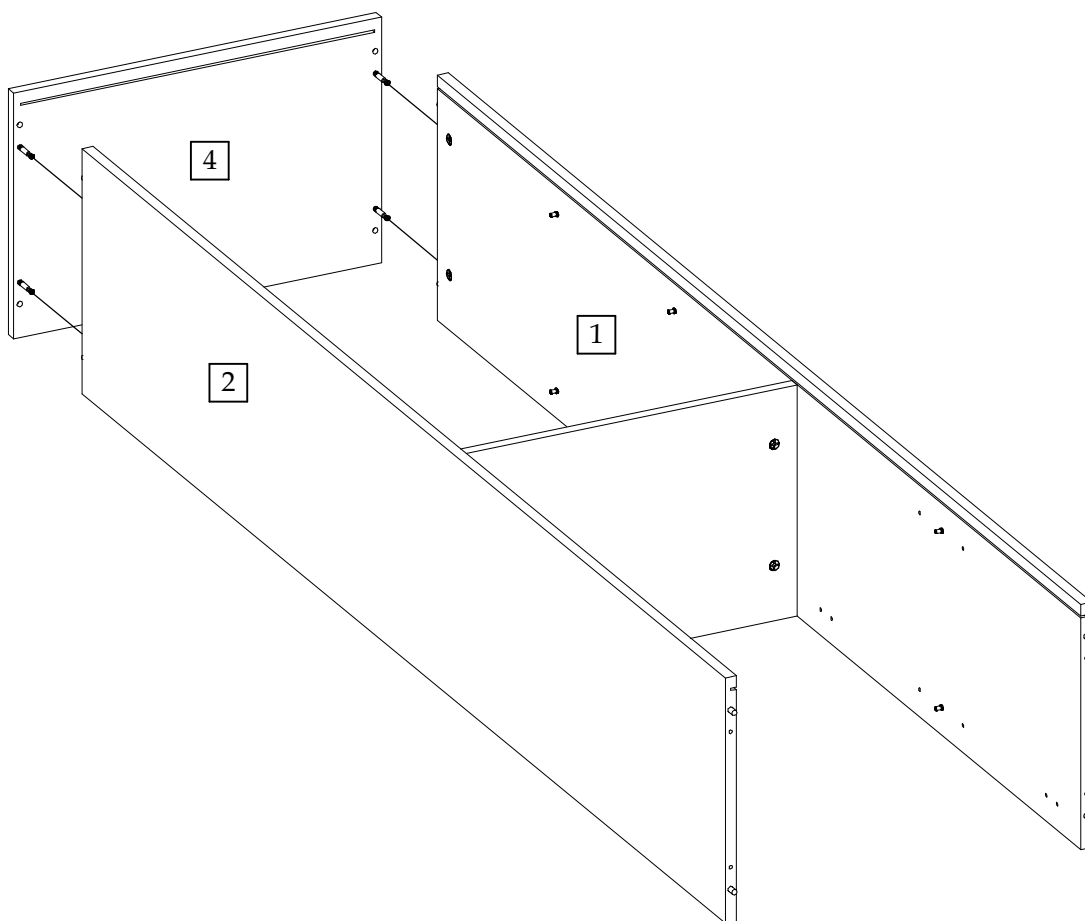

5

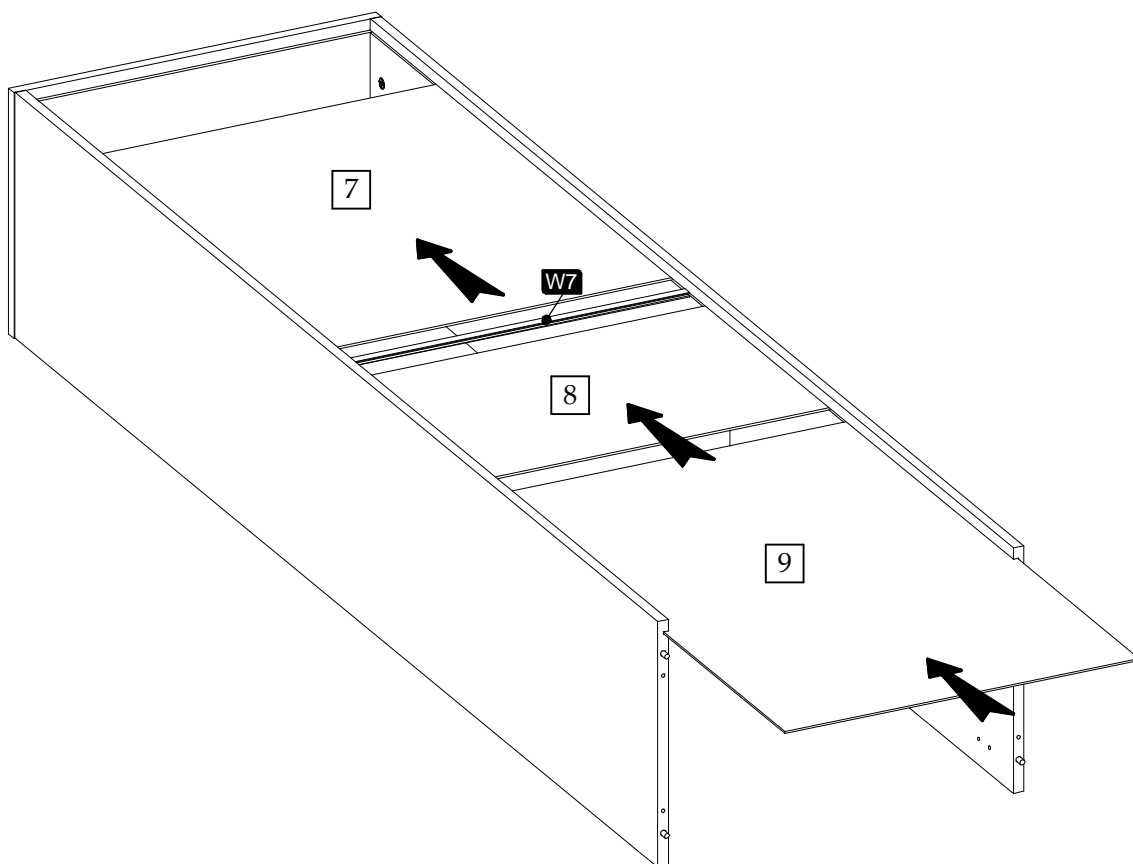

6

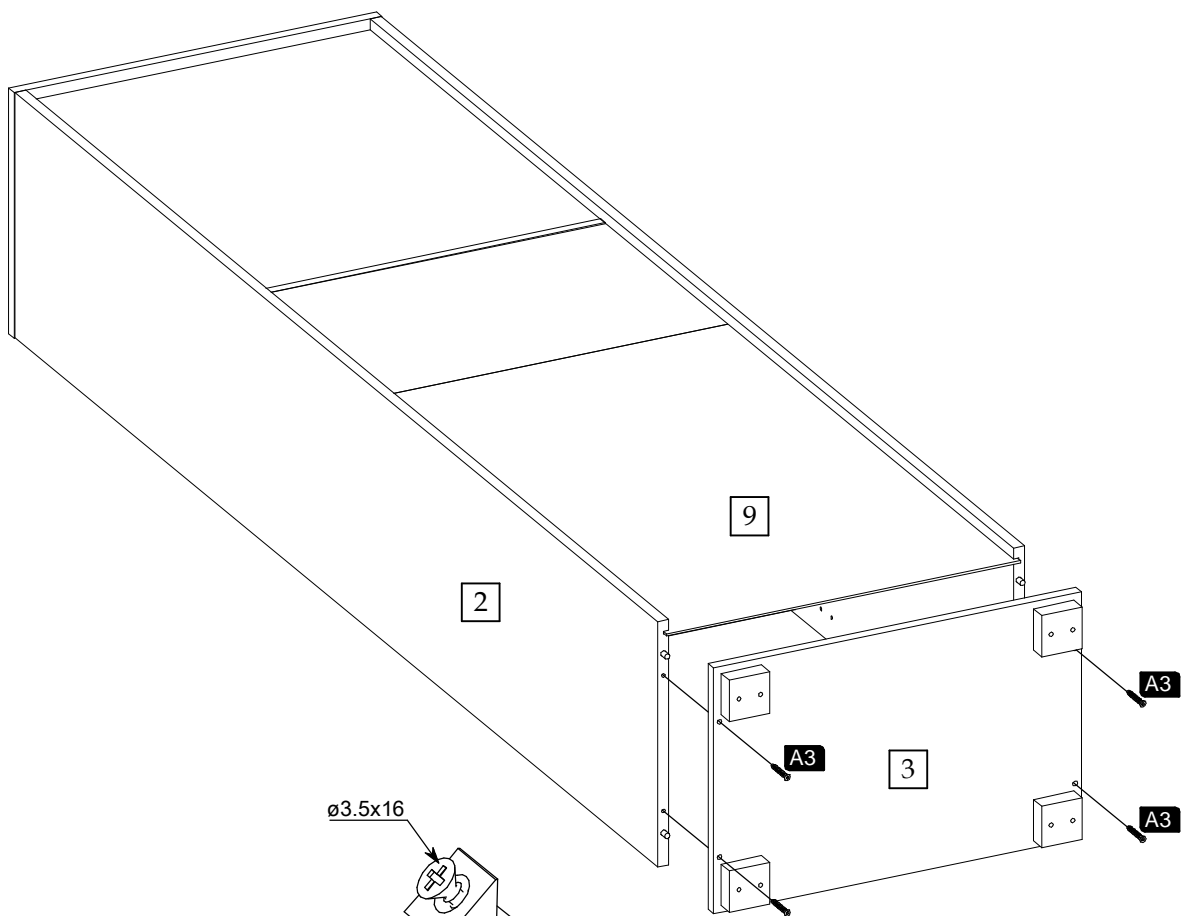

7

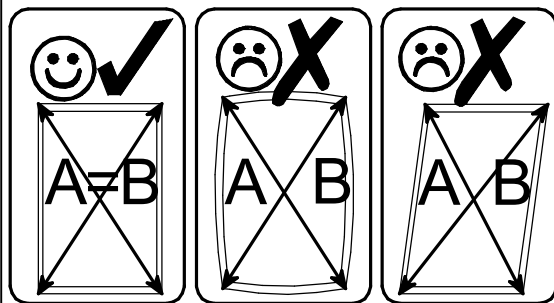
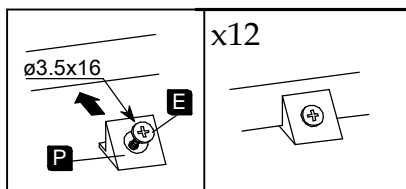
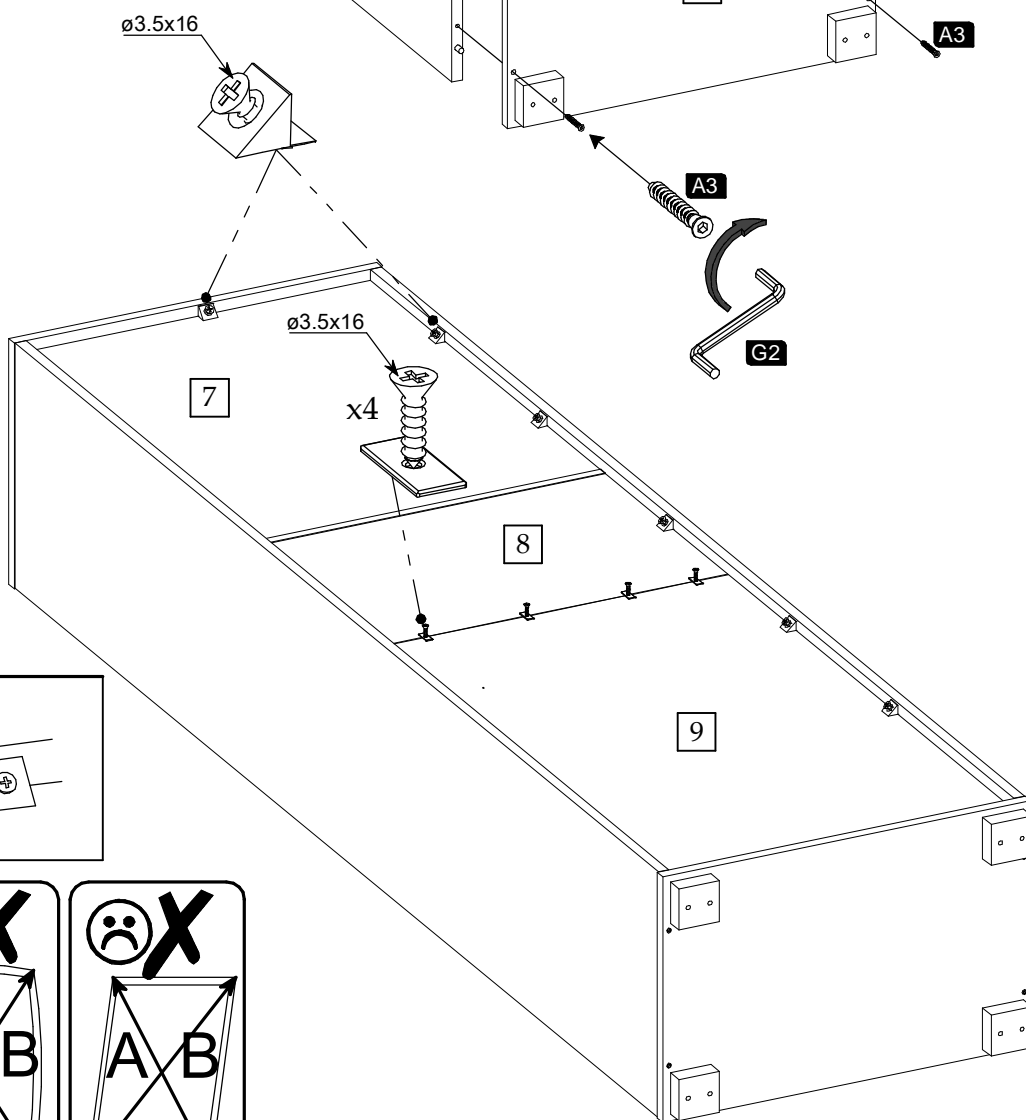

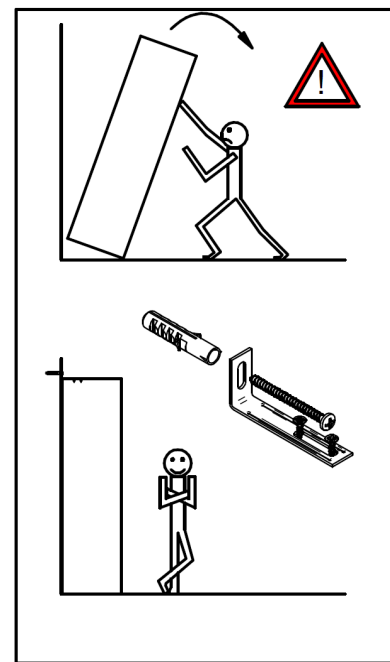
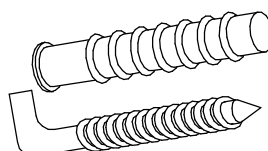
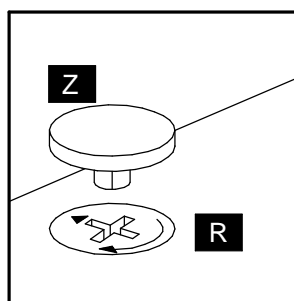
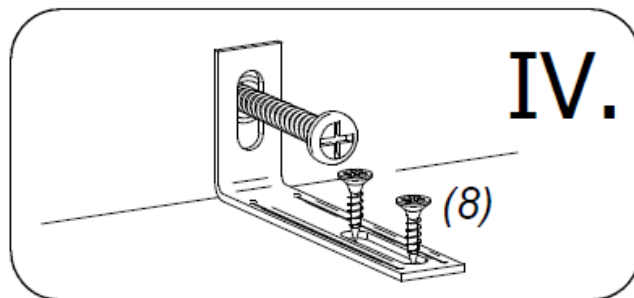
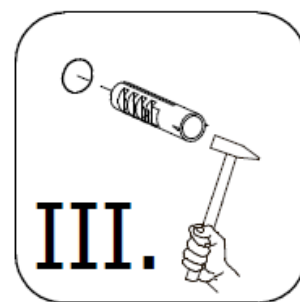
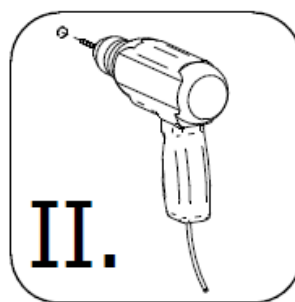
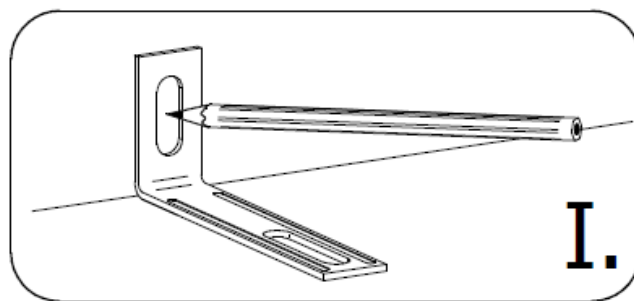
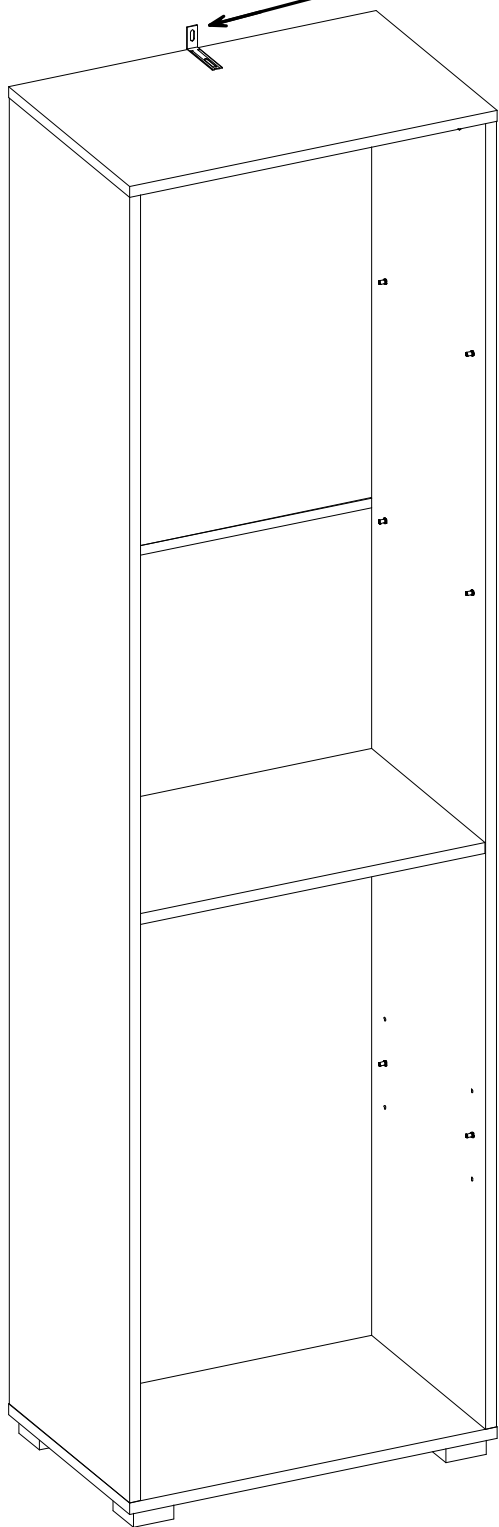

9

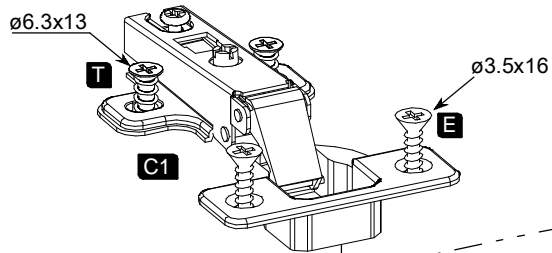
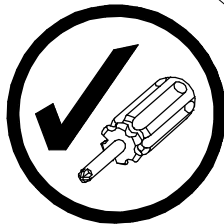
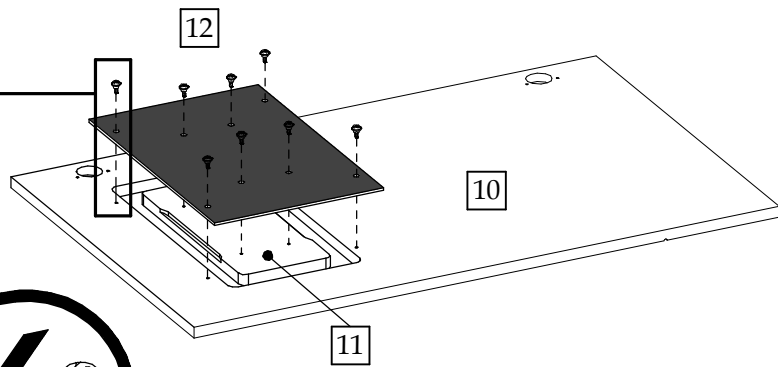
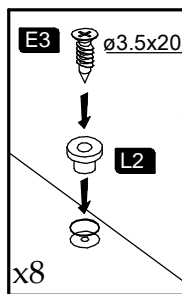

10

