

SPLIT

Typ B

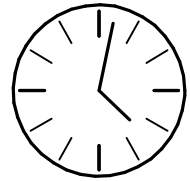

60 min

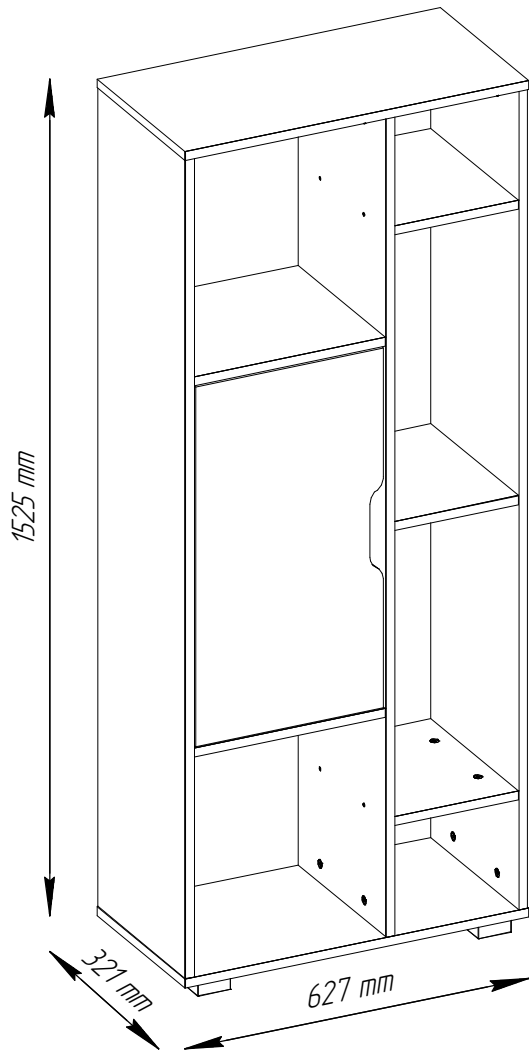
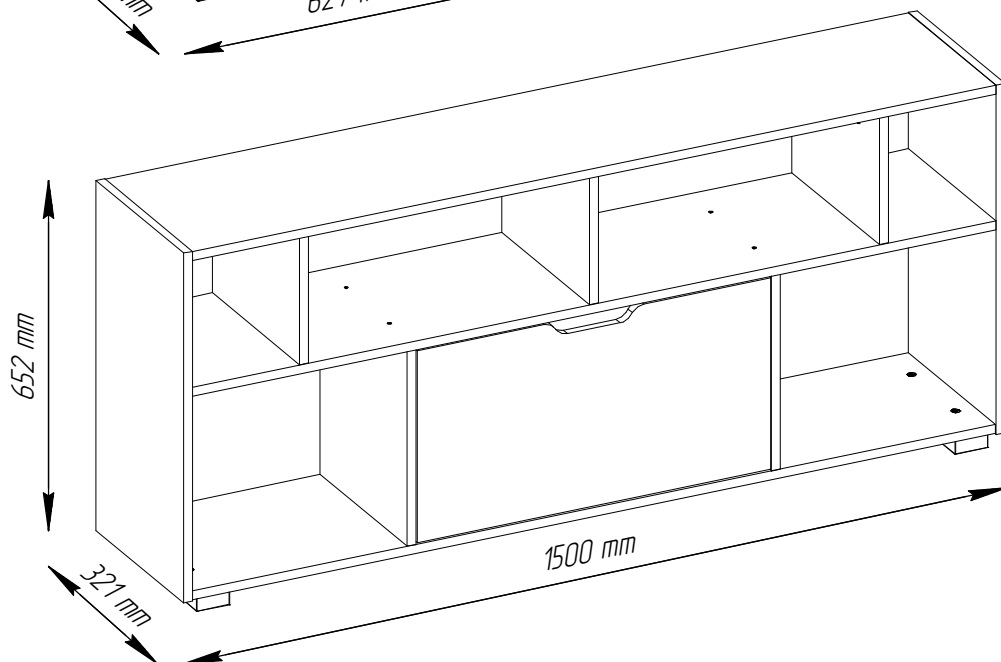
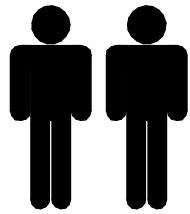

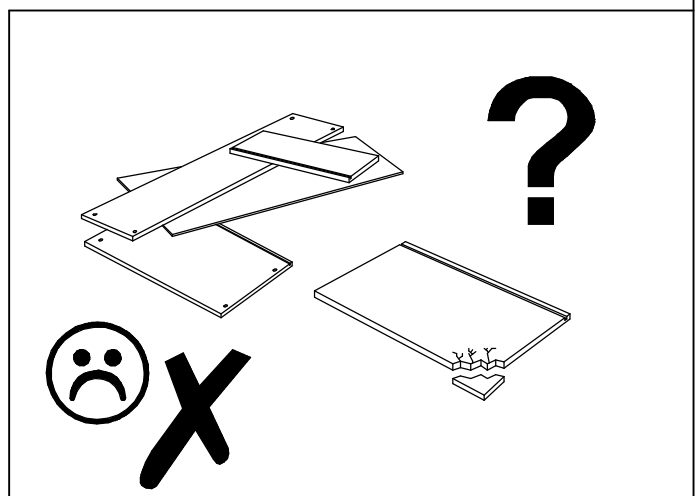
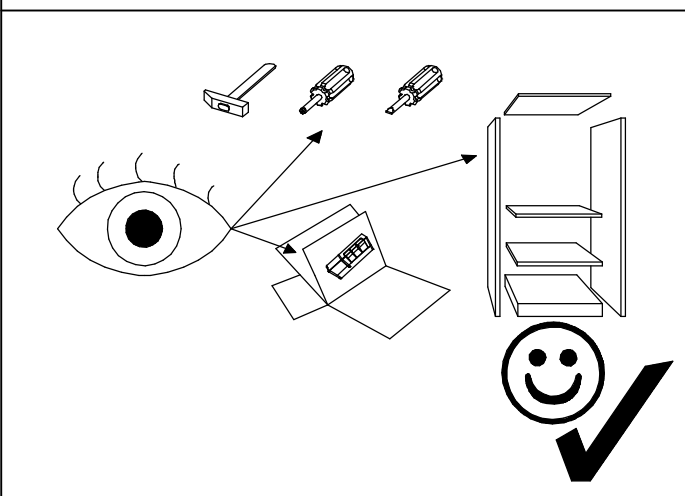
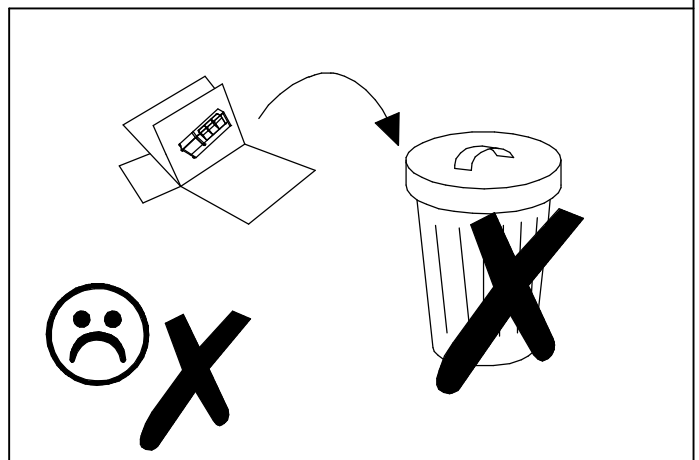
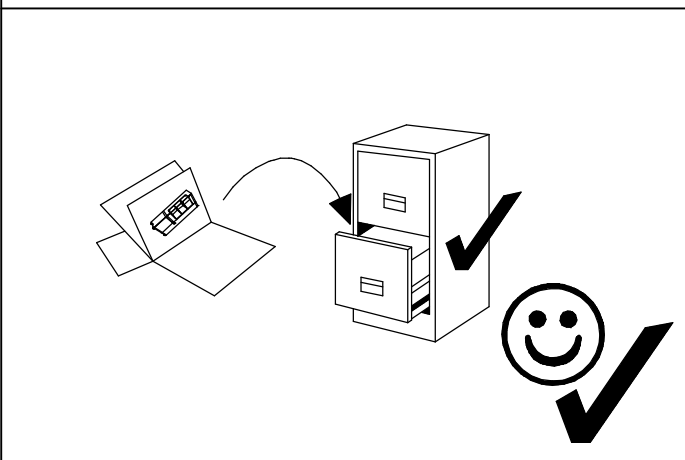
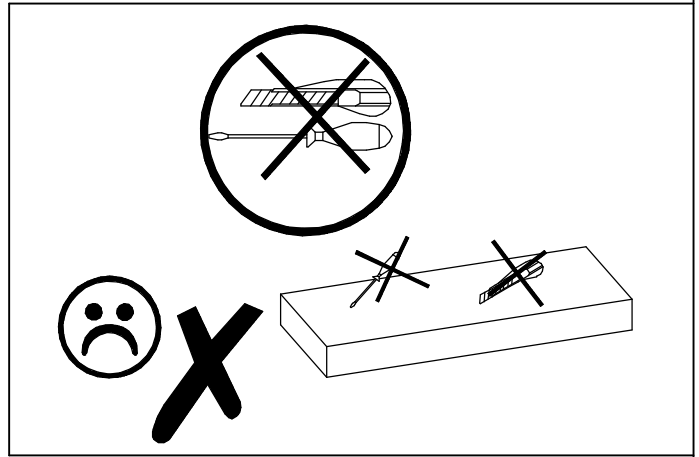
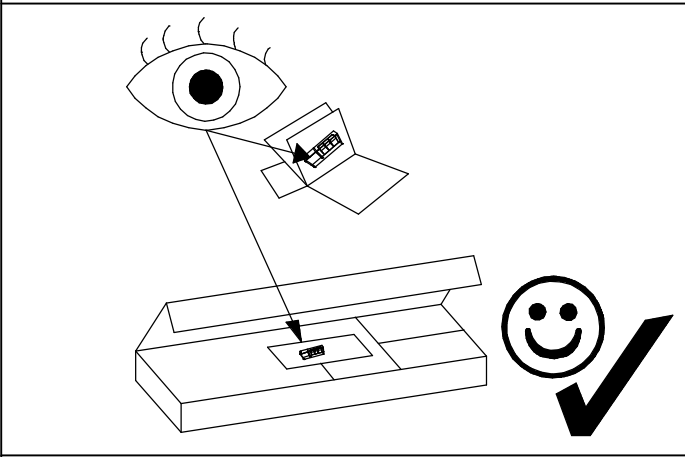

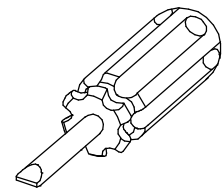
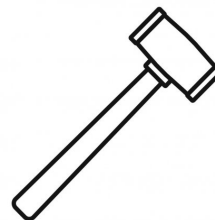
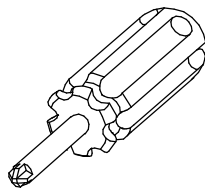
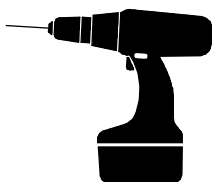
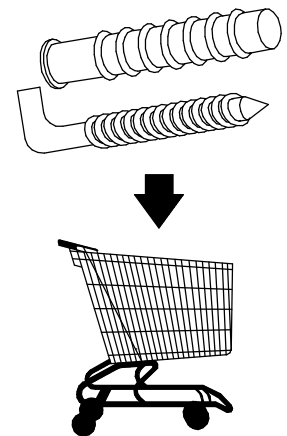
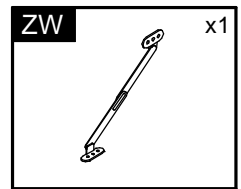
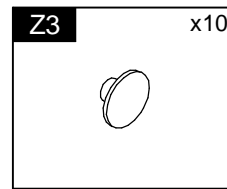
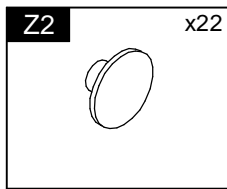
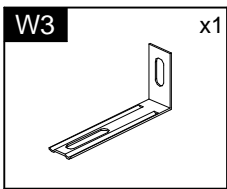
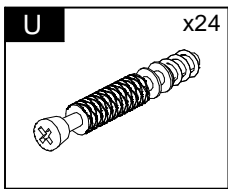
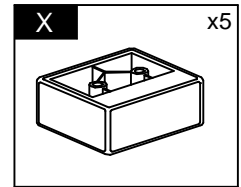
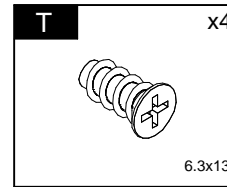
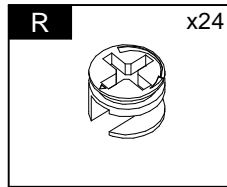
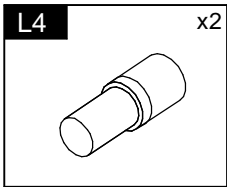
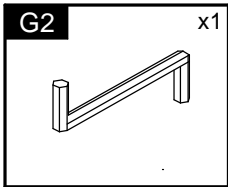
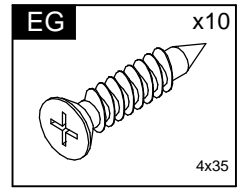
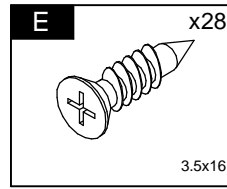
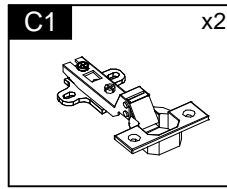
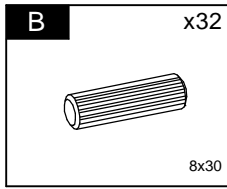
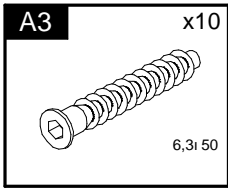
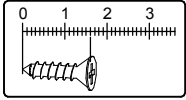
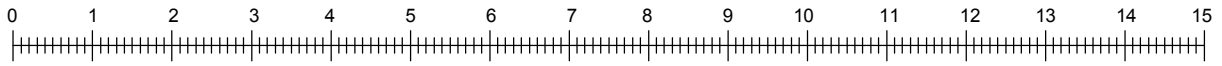

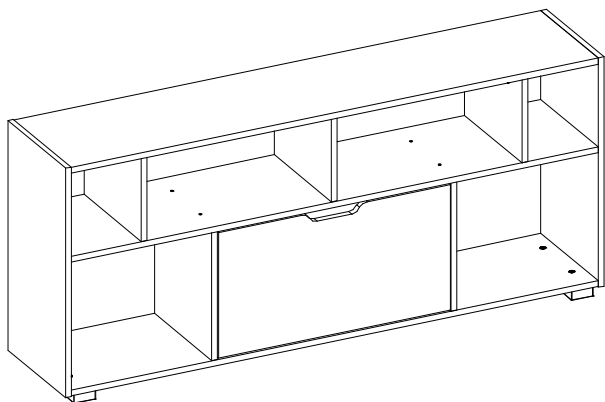

Element symbol	Measurements				Code	Paket
1	627	321	16	1	1002	1/2
2	627	321	16	1	1003	2/2
3	1468	320	16	1	1004	2/2
4	1468	320	16	1	1005	2/2
5	1468	320	16	1	1006	2/2
6	350	318	16	1	1007	1/2
7	350	318	16	1	1001	1/2
8	227	319	16	1	1010	2/2
9	227	319	16	1	1011	1/2
10	227	319	16	1	1012	2/2
11	344	648	16	1	1008	1/2
12	378	678	3	1	N\A	1/2

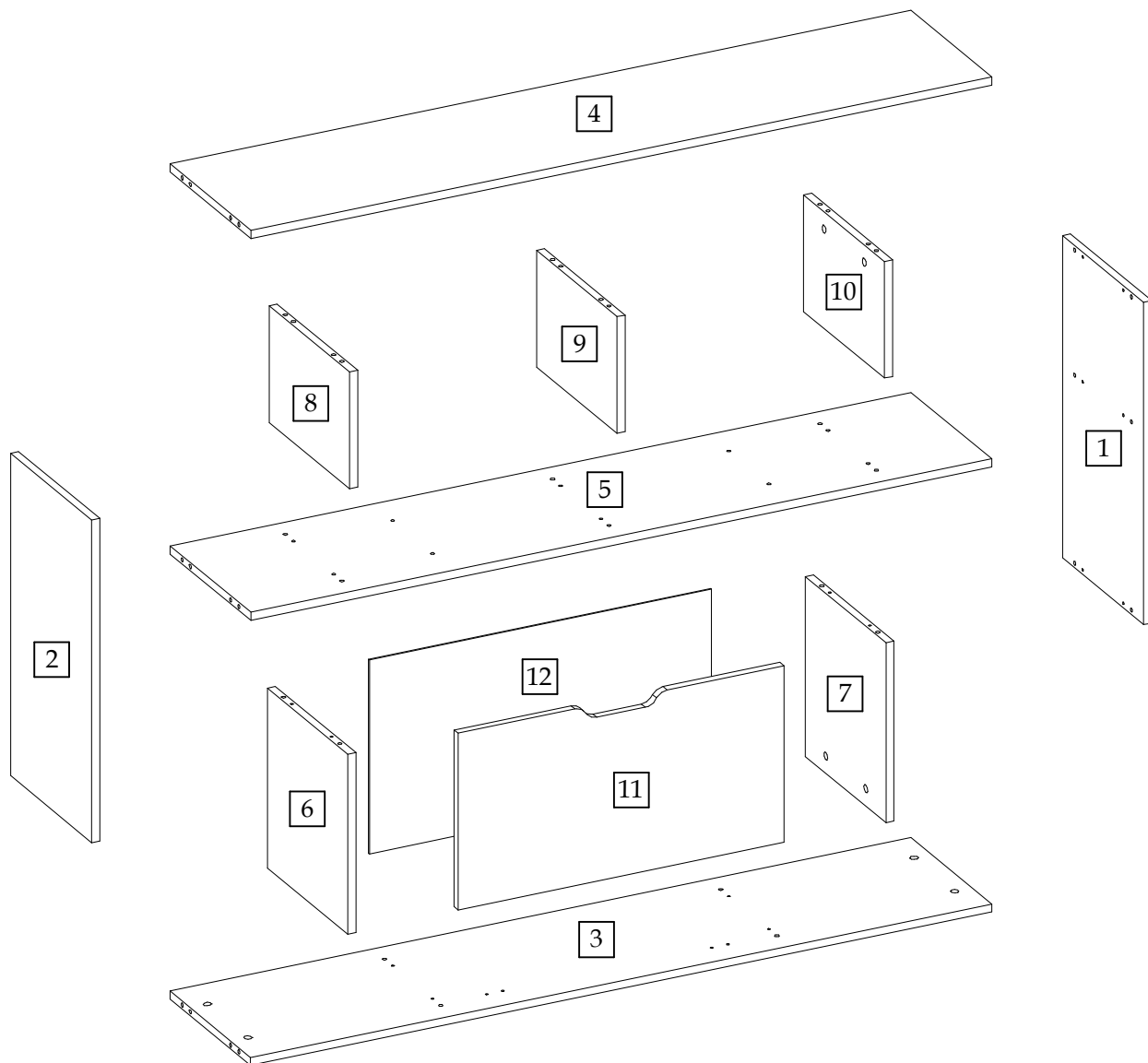

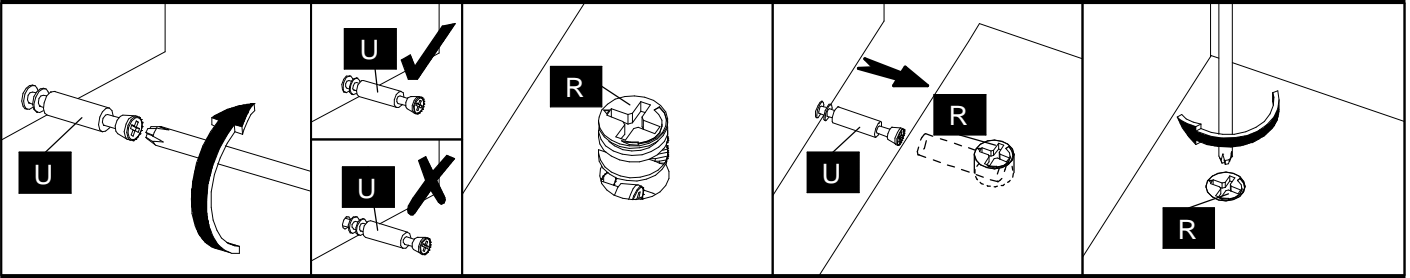

1

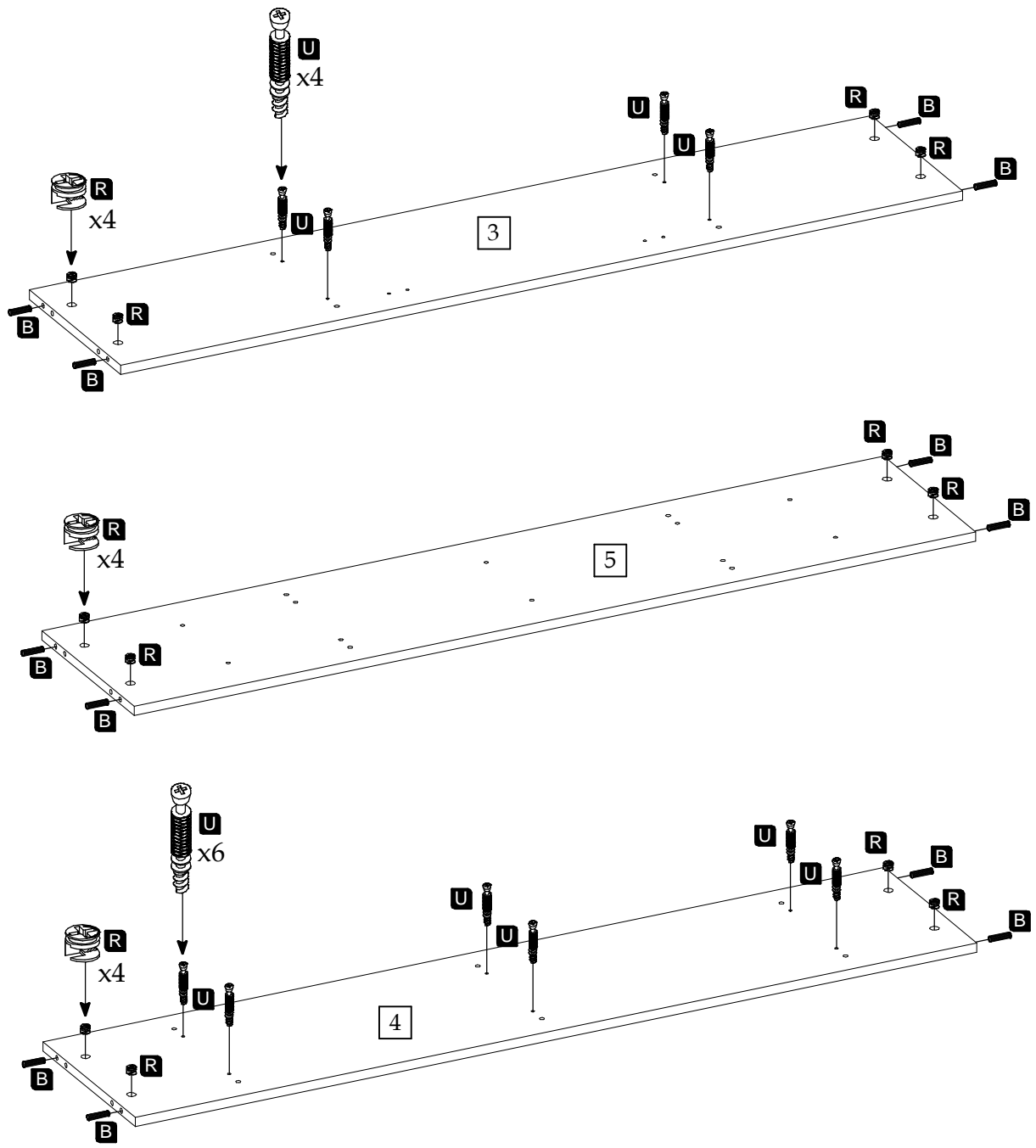

2

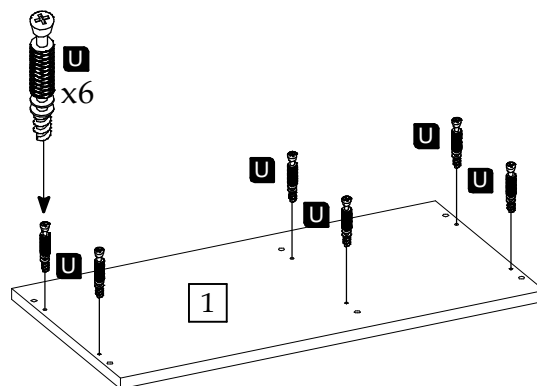
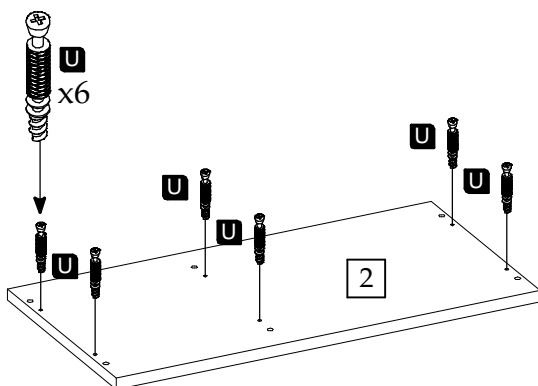
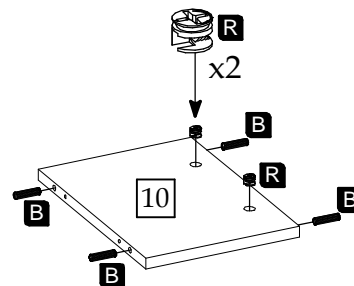
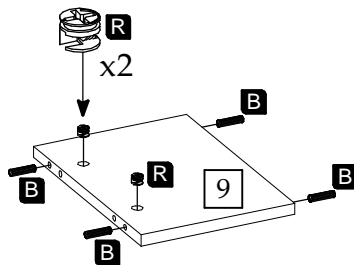
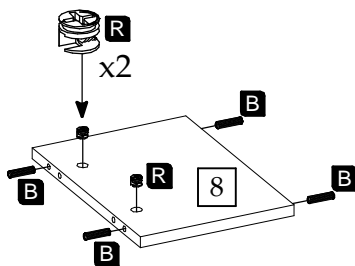
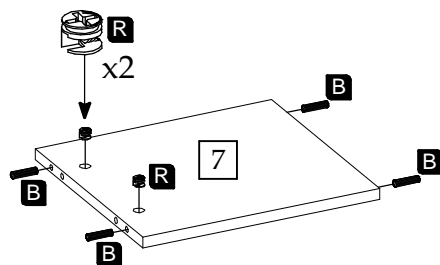
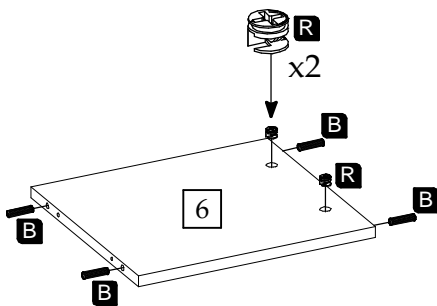

3

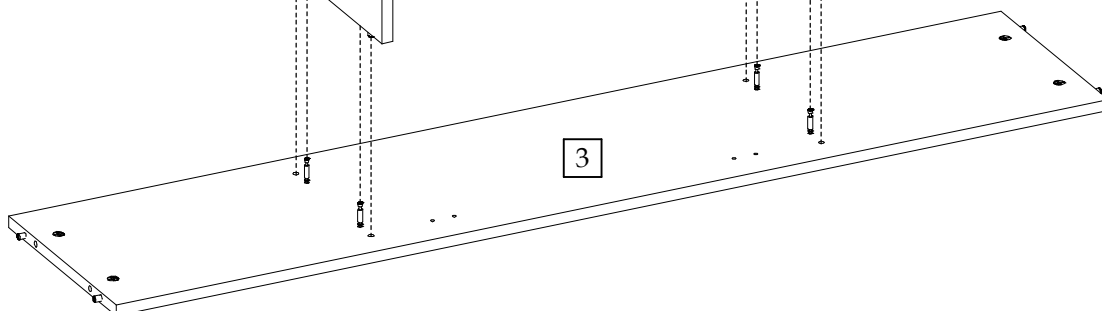
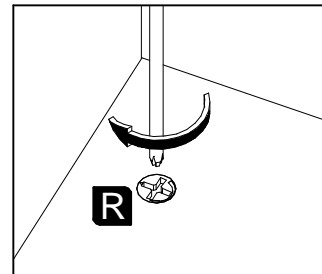
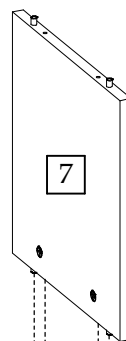
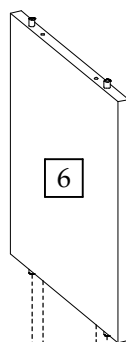
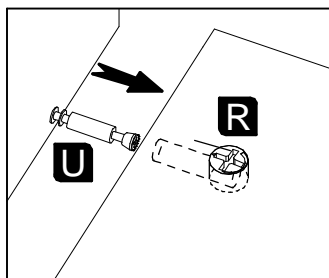

4

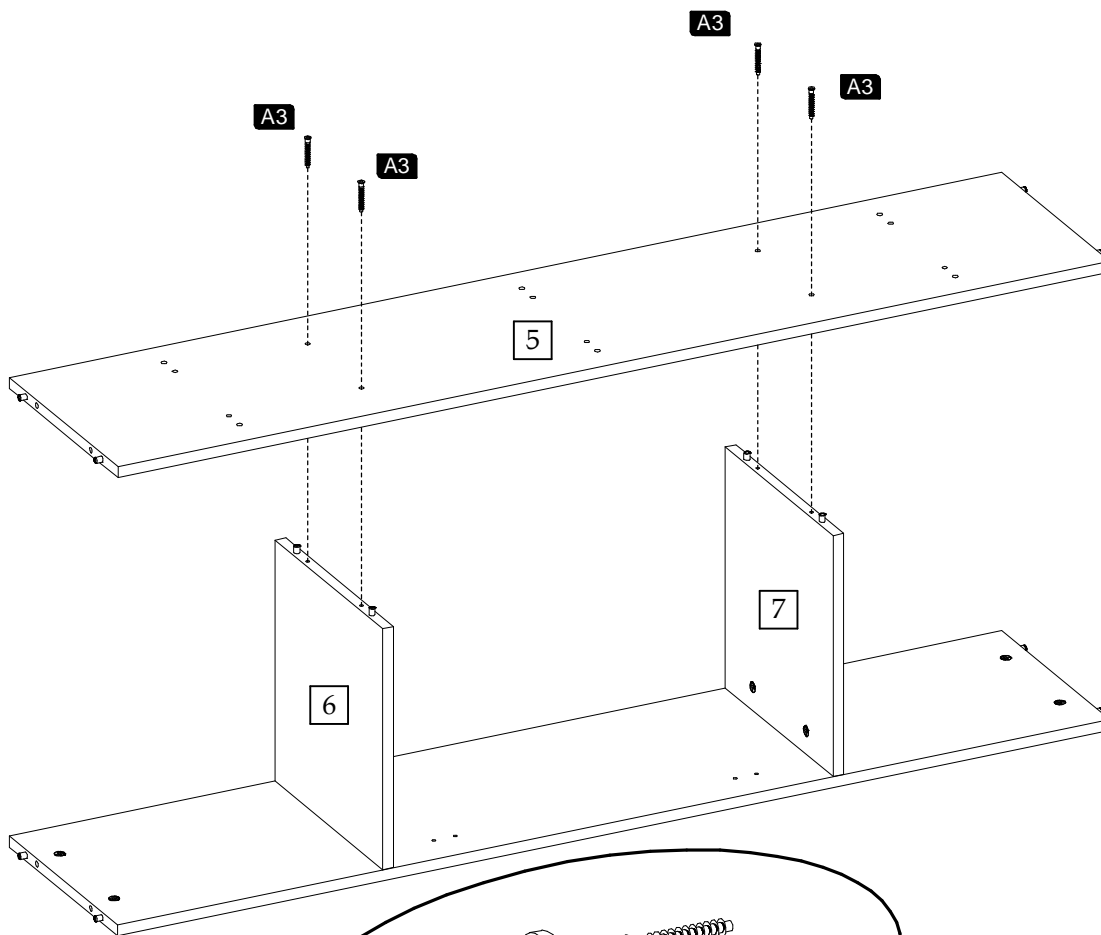

5

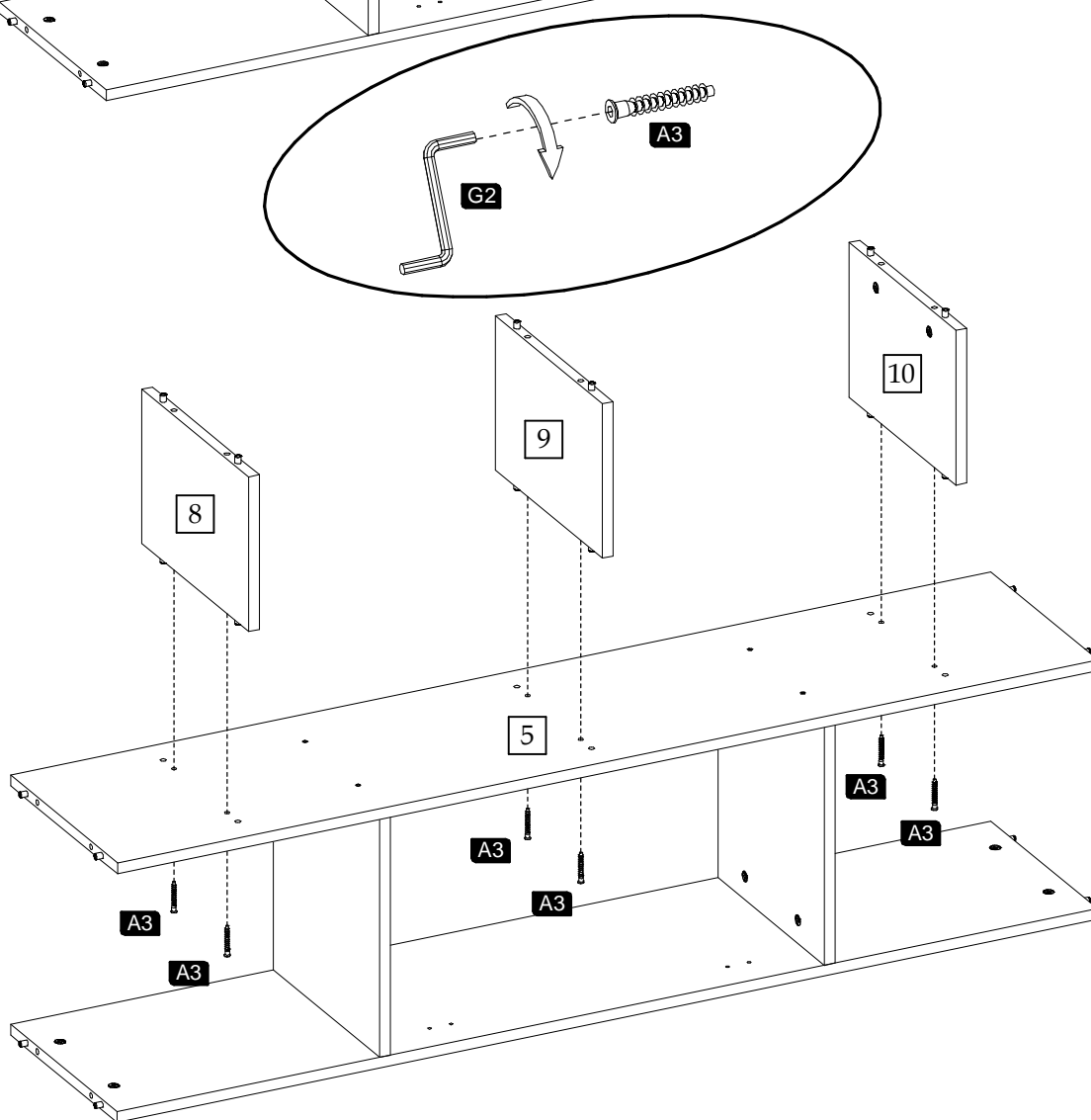

6

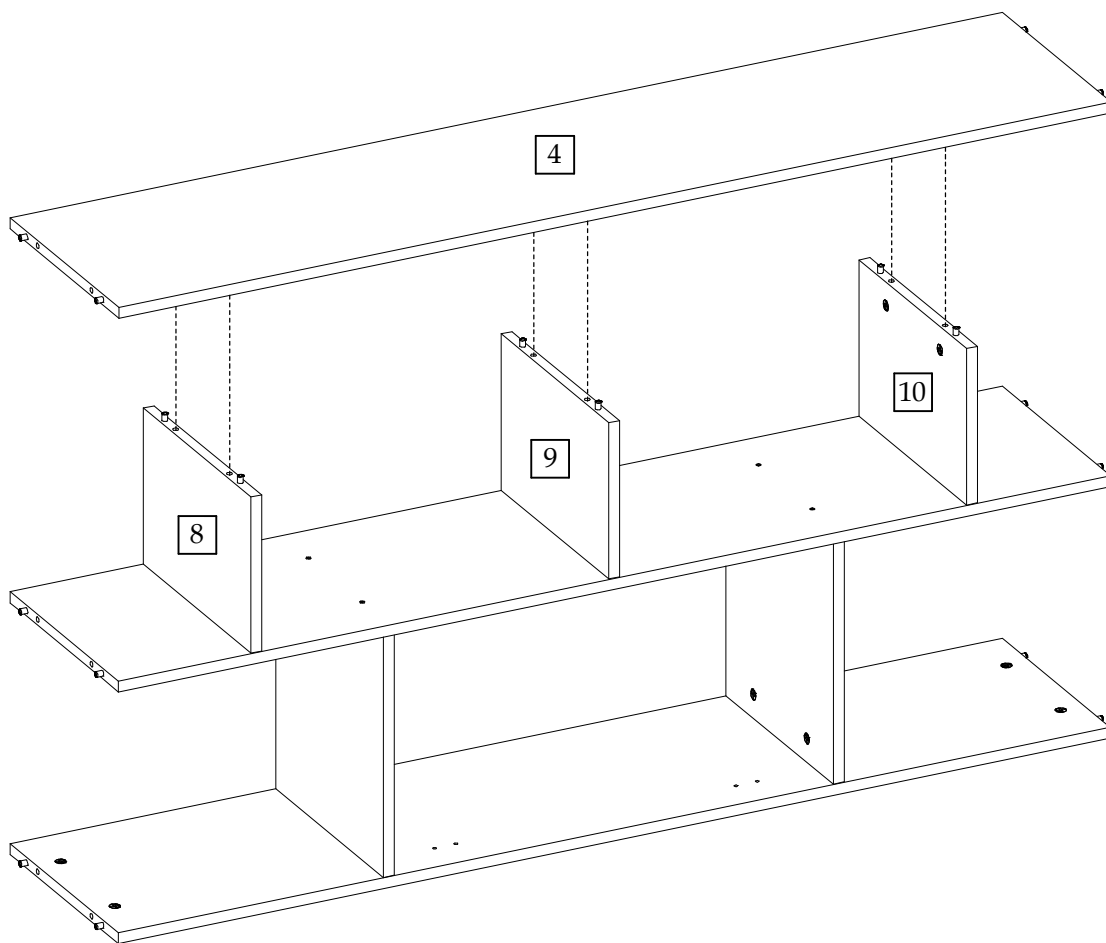

7

